

FESTO

Selected products



Your partner for factory and process automation

Selected products
Your partner for factory and process automation
7th edition

Edition 2021/02

All technical data is correct at the time of going to print.
All texts, illustrations, images and drawings included in this catalogue are the intellectual property of Festo SE & Co. KG, and are protected by copyright law.
No part of this publication may be reproduced or transmitted in any form or by any means, electronic, mechanical, photocopying or otherwise, without the prior written permission of Festo SE & Co. KG.

All technical data is subject to change according to technical updates.

Festo SE & Co. KG
Postfach
73726 Esslingen
Ruiter Straße 82
73734 Esslingen
Germany

Legend:

Grey text on the product pages:
You can find these products online

Example:

Standards-based cylinder
DSBG









→ www.festo.com/catalogue/dsbg

Blue type code on the product pages:

Type code for online searches

dsbg

→ www.festo.com/catalogue/dsbg

	Editorial	2	©
	Pneumatic drives	12	01
	Electric drives	68	02
	Motors and servo drives	112	03
	Handling systems	126	04
	Vacuum technology	130	05
	Valves	142	06
	Valve terminals	194	07
	Sensors	216	08
	Compressed air preparation	240	09
	Electrical connection technology	272	10
	Pneumatic connection technology	282	11
	Control technology and software	308	12
	Other pneumatic equipment	312	13
	Process automation	318	14
	Appendix	360	©



Editorial

Axis definition

Find your handling solution in a few steps

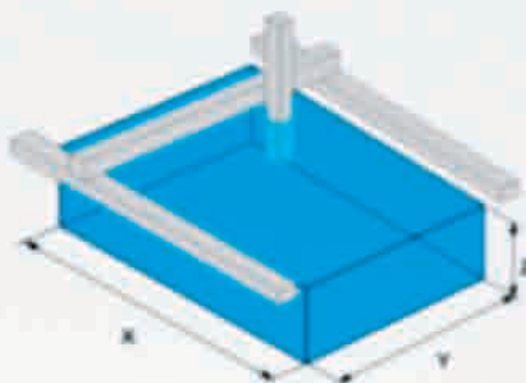

Define the driver system and working stroke

Drive system of the axis

Required working stroke

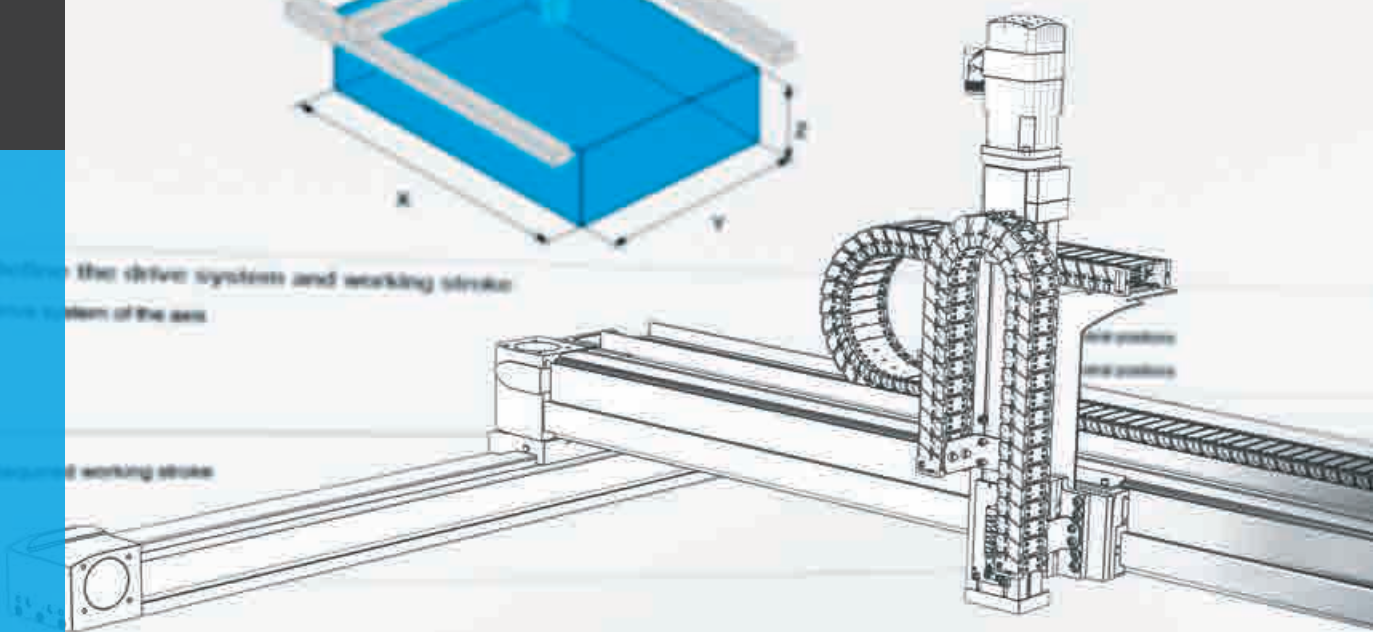



Contents

Preface	4
Digital products and services	6
Wide range of industry segments – one competent partner.	8
Your partner for safety	10



We are pneumatic.
We are electric.
We are 30,000 technology-neutral solutions.

→ WE ARE THE ENGINEERS
OF PRODUCTIVITY.

Dear customers and distribution partners,

The new edition of the catalogue has once again grown by a few pages. This is because we are continuously expanding our range for you, so that you can rely on products from Festo for the vast majority of your automation needs. Regardless of whether you or your customers have a preference for electric or pneumatic automation, you will find the right products for the entire control chain in every case. By having a combined approach to automation, you can make the most of the strengths that electric and pneumatic technology have to offer.

In our standard range you will see many new products that provide the best and most attractively priced solution to large parts of your automation requirements. We have therefore organised our production and logistics to ensure that fast delivery worldwide goes without saying, even for large quantities. And we have also reworked products such as the round cylinder DSNU to make it even more streamlined – with the same performance.

Our electric automation range delivers seamless connectivity, mechanical, electrical and intelligent, from the workpiece to the cloud. It extends from cost-effective and simple movement between two end positions using the Simplified Motion Series and the electric cylinder units EPCS-BS or the rotary drive units ERMS to highly complex and flexible servo drive solutions. And thanks to the Festo Automation Suite, commissioning is easier than ever. State-of-the-art communication and control concepts can be realised with innovative servo drive technology like the servo drive CMMT-ST, the corresponding motors EMMT-AS and direct integration into networks as well as clever software solutions.

For process automation, too, we have added essential products, such as the ball valves VZBA or the linear actuators DFPC, to the catalogue for you. Configurators such as the CGO for control cabinets or KVZA for butterfly valve units guide you directly to the right product in the proper size. These are tools that make engineering easy and reliable are also part of our digitalisation strategy.

As you can see, we do everything to make sure you always receive the right products. In particular, we pay close attention to three things: top quality, short delivery times and attractive prices. And of course we are always there for you if you have questions or need advice. In person, over the phone or online.

I hope you enjoy this edition of the catalogue, and that it gives you lots of new ideas.



Dr. Ansgar Kriwet
Member of the Management Board Sales of Festo SE & Co.KG

Digital products and services

Comprehensive digitalisation concepts

All our development activities for digitalised automation revolve around one question: how can we make you more productive across the entire value chain? From initial engineering, procurement and commissioning to maintenance and operation? No matter where you are in this value chain, at Festo you will find the right digital offer for your needs.

You can already optimise your production and your processes with data analytics, machine learning and artificial intelligence from Festo. With these methods, this transformation will result in new business models.

Software tools from Festo support you in every phase of the machine lifecycle, from initial planning to the modernisation of your plant. They are small, practical tools that make your work easier and much more productive. We have compiled a selection of them here.

→ www.festo.com/engineeringtools

Pneumatic Sizing



→ www.festo.com/pneumaticsizing

You may have already asked yourself: isn't there a quicker and more accurate way to calculate the optimal pneumatic control chain? Yes, there is! Pneumatic Sizing doesn't just offer you one design version, but up to three that are suitable for your application. By entering three application parameters such as load, stroke and positioning time, you will get up to three suggestions: the precise result as well as the performance and eco versions.

Pneumatic Sizing allows you to benefit from:

- Optimal air consumption
- The ideal travel time per cycle
- Direct connections to the Festo Online Shop.

Festo Design Tool 3D



→ www.festo.com/fdt-3d-online

Festo Design Tool 3D is a 3D product configurator for generating Festo-specific CAD product combinations. Your search for matching accessories for standard components with fast delivery, for example for pneumatic cylinder series DSBC, DSNU and ADN, will be faster, more reliable and easier in the future. At the same time your documentation effort is reduced and traceability is simple: generate PDF assembly drawings and bills of materials within the Festo Design Tool 3D and query the traceable order code in the Support Portal.

The benefits for design, purchasing and commissioning:

- Quick and easy automated generation of product combinations
- Shorter bills of materials, fewer sources of error and optimised ordering processes thanks to a single order code for the complete assembly
- Native CAD models for retaining CAD/component links (CAD Constraints, CAD Mates)
- Simplified, accelerated processes in the warehouse and during assembly

Schematic Solution for EPLAN projects

This circuit diagram service for complete EPLAN projects is unique to Festo: EPLAN Schematic Solution documents your individually configured solutions in next to no time. 3D CAD data and product information for standard catalogue products have been available for 15 years. With EPLAN Schematic Solution you simply enter the order code and receive the complete plan in just a few minutes – error-free and trouble-free. No more tedious searching for, downloading and piecing together individual components.

- Intuitive, fast and reliable: error-free documentation at the push of a button
- Full mechatronic layout of configured products like CPX, VTSA, MPA
- Reliably automated in accordance with the standards IEC 61355, IEC 81346, ISO 1219



→ www.festo.com/eplan

FluidDraw – circuit diagrams for complete systems

Planning and documenting electric and pneumatic components in your system have never been easier. FluidDraw gives you direct access to the catalogue and any online baskets you saved at Festo, as well as letting you import additional databases and use a standardised symbol library. For maximum convenience choose the FluidDraw 365 software subscription with regular updates and the latest upgrades.

- IMX and Eplan interfaces
- Tubing lengths, wire and cable lengths
- Standardised hydraulic symbols to ISO 1219



→ www.festo.com/fluiddraw

Smartenance – the digital maintenance manager

Smartenance makes your maintenance management paperless, transparent and efficient. It lets production managers, system operators and maintenance staff schedule autonomous maintenance tasks, report faults on the move and document all their measures. While the web-based application provides administrative support, the app gives access to maintenance schedules and attachments from anywhere. Smartenance is quick and easy to install, self-explanatory and a simple and cost-effective introduction to digitalisation.

- For production managers and plant operators: digital maintenance management directly on the shop floor
- For auditors: detailed proof with one click
- Cloud-based: mobile access from anywhere
- Feedback function: quick and easy collaboration in the maintenance team
- Seamless connectivity thanks to API
- Complete documentation of all activities



→ www.festo.com/smartenance

The Festo App World

Festo has set up a separate portal, the Festo App World, for purchasing and using the apps, cloud products, software libraries and added value services.

You can make purchases directly online here, view the relevant apps for your hardware via your Product Key as well as your order history, and set up subscription models or subscriptions.

Simply log in with your Festo account, select the digital product you want, and add it to your basket. You can also just forward the basket to the appropriate colleagues authorised to make purchases.



→ www.festo.com/appworld

Wide range of industry segments – one competent partner.

Food and packaging industry



From continuous processes through food and splash zones to end line packaging:

- Solutions for controlling special media flows
- Food-safe materials for clean design automation components
- Handling systems with suitable gripper solutions
- Technology mix: electric, pneumatic and servo-pneumatic

→ www.festo.com/food

→ www.festo.com/packaging

Automotive industry and Tier 1 suppliers



- Understanding the processes – from the press shop through to engine and gearbox production and tier 1 suppliers
- Developing solutions – joint engineering projects
- Creating synergies – everything from a single source

→ www.festo.com/automotive

Small parts assembly and electronics



- Know-how along the entire process chain
- From wafer production at the front end to finished chips at the back end
- For quality inspection and assembly of the finished products
- In small parts assembly, electronic or non-electronic

→ www.festo.com/ela

Wide range of industry segments – one competent partner.

Water treatment



- Integrated automation solutions for the key processes: water and wastewater treatment
- Customer-oriented consulting and engineering
- Supply of components and pre-assembled systems
- Compressed air quality analyses
- Energy Saving Services

→ www.festo.com/water

Biotech, pharma and cosmetics industry

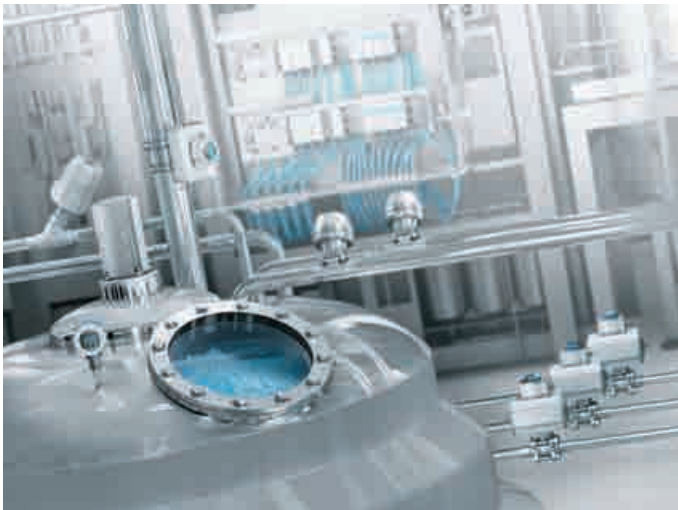

- Integrated automation solutions for the key processes: production of active ingredients, manufacturing of pharmaceuticals, cosmetics and personal care products, filling and packaging
- Customer-oriented consulting and engineering
- Supply of components and pre-assembled systems
- Compressed air quality analyses
- Energy Saving Services

→ www.festo.com/biotech

Your partner for safety

Reduce risk – think preventively: Safety@Festo

Machines have to be designed in a way that protects people, animals, property and the environment from harm. The objective is to prevent physical damage of any type. With safety-oriented pneumatics from Festo, you can be sure that implemented safety measures are in compliance with the EC Machinery Directive. Festo offers many safety solutions for the entire control chain in the area of electrics and pneumatics, for input, logic and output.

These can be individual products, customer-specific solutions, proposals for safety-related circuit diagrams or training courses. Festo Didactic offers training and consulting services on standards and directives as well as risk assessments and assessments of technical safety measures.

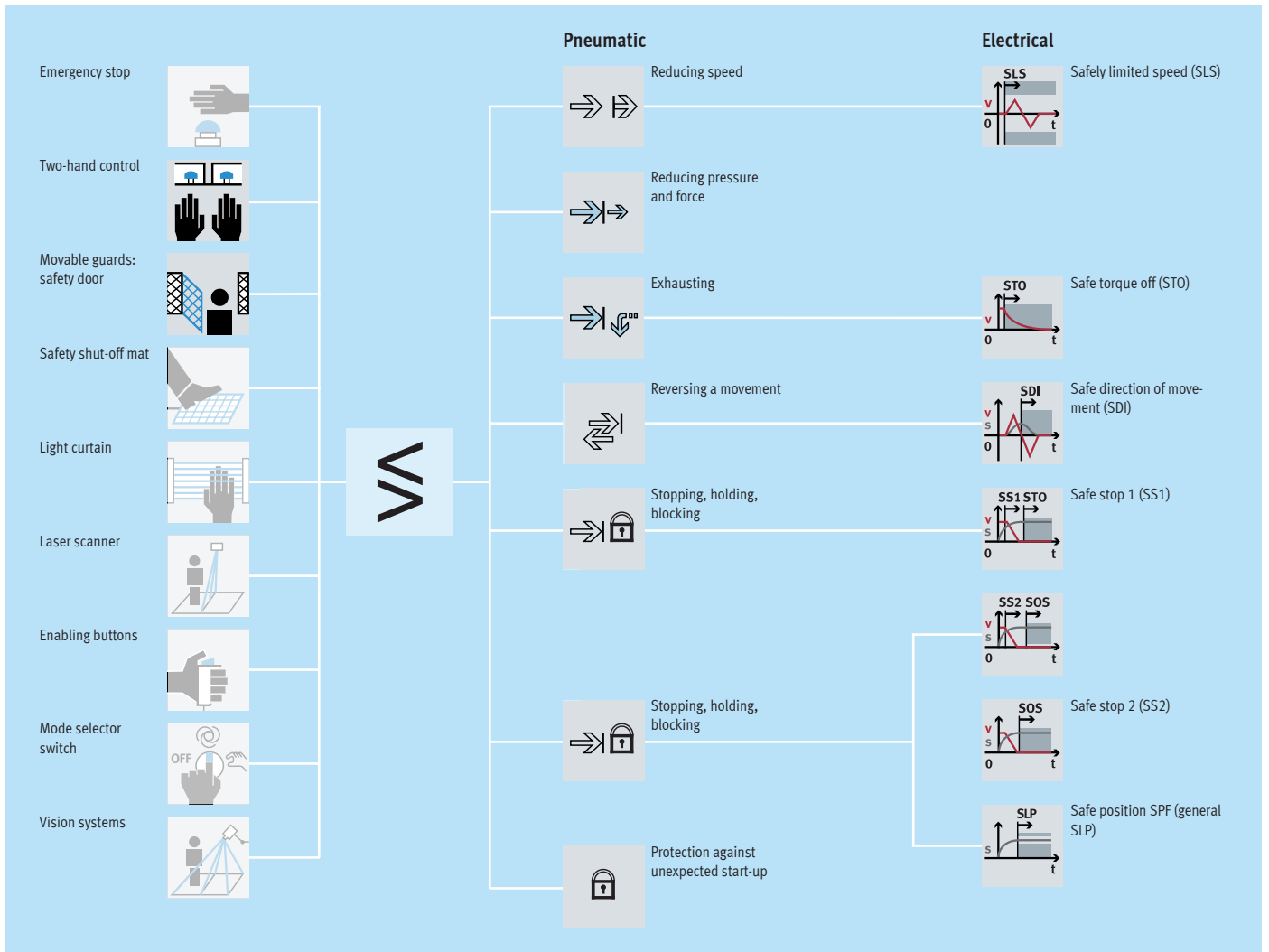

Just ask your local contact person or find out more at

→ www.festo.com/safety

01

Pneumatic drives

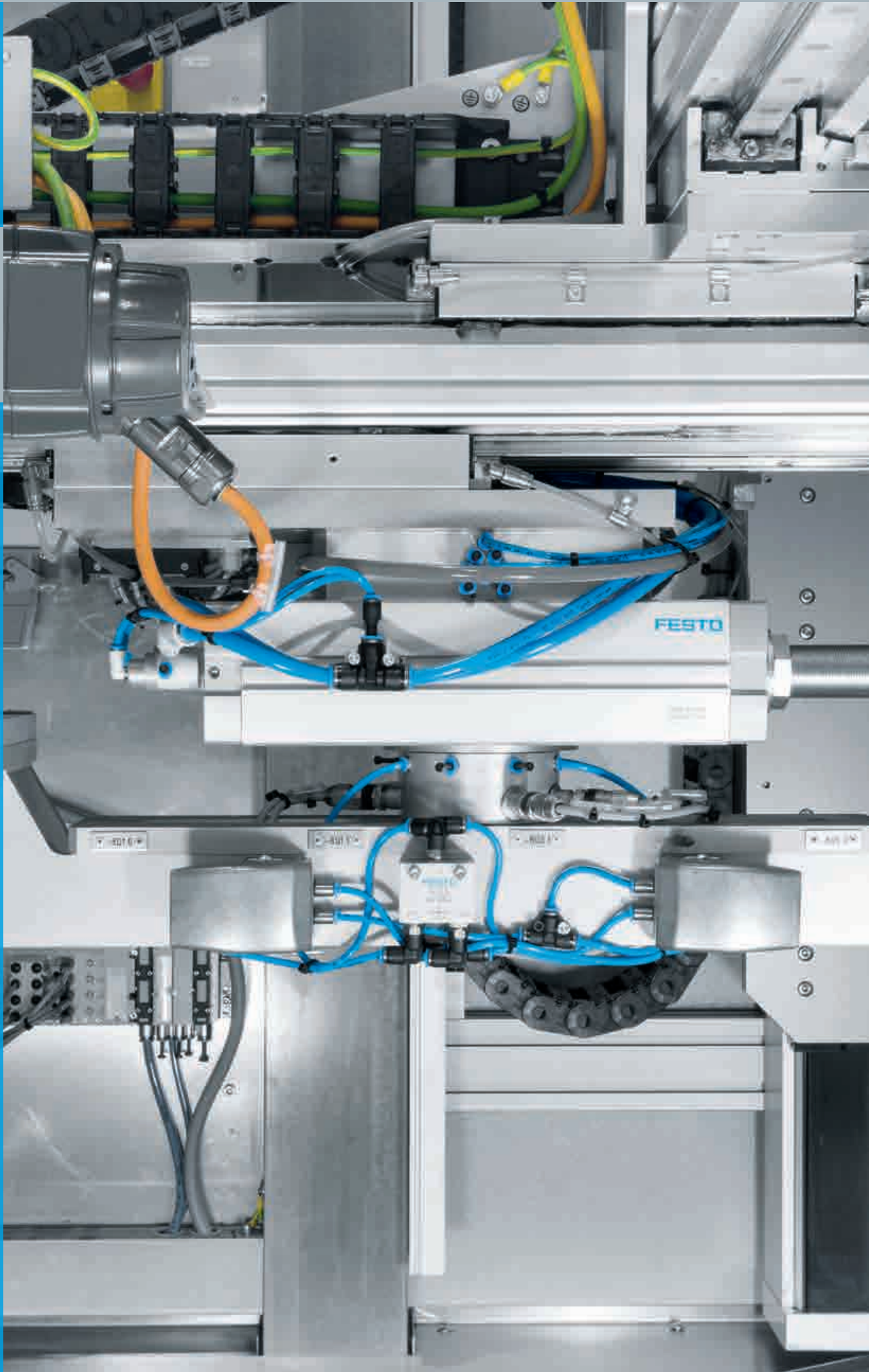

Highlights



Compact cylinders

ADN-S/AEN-S

- + Minimal installation space
- + Perfect for micro-movements

→ 39



Mini slides

DGST

- + Powerful twin-piston drive
- + Shortest mini slide on the market
- + Precision recirculating ball bearing guide
- + Versatile mounting options

→ 62

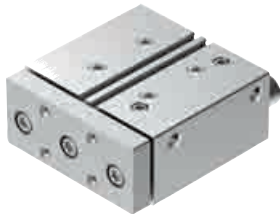

Guided drives

DFM

- + Minimal cycle times
- + High load capacity with integrated guides
- + Wide range of mounting options

→ 64



Contents

Product overview	14
Self-adjusting end-position cushioning PPS for standards-based cylinders	25
Standards-based cylinders DSNU, to ISO 6432, double-acting	27
Round cylinders DSNU, double-acting	29
Round cylinders DSNU-S, double-acting	31
Standards-based cylinders DSBC, to ISO 15552, double-acting	33
Standards-based cylinders DSBF-C, to ISO 15552, clean design	36
Compact cylinders ADN-S/AEN-S, double-acting/single-acting	39
Compact cylinders ADN, to ISO 21287, double-acting	43
Short-stroke cylinders ADVC/AEVC, double-acting/single-acting	46
Standards-based cylinders CRDSNU, to ISO 6432, stainless steel	49
Round cylinders CRDSNU, stainless steel	51
Linear drives DGC-K, double-acting	53
Linear drives DGC, double-acting	55
Semi-rotary drives DRVS, double-acting	58
Twin-piston semi-rotary drives DRRD, double-acting	60
Mini slides DGST, double-acting	62
Guided drives DFM, double-acting	64
Piston rod attachments SG, SGS, FK	66

Product overview



Software-Tools

01
Pneumatic drives

<p>Pneumatic simulation</p>		<p>Perfect simulations replace expensive real-life tests. The tool is an expert system that supports you in the selection and configuration of the entire pneumatic control chain. If one parameter is changed, the program automatically adapts all the others.</p> <p>This tool can be found</p> <ul style="list-style-type: none"> on our website at www.festo.com/catalogue by clicking on the blue button 'Engineering'.
<p>Festo Design Tool 3D</p>		<p>The Festo Design Tool 3D is a 3D product configurator for generating specific CAD product combinations from Festo. The configurator makes your search for the right accessory easier, more reliable and faster.</p> <p>You can then order the module that has been created as a single order item, either completely pre-assembled or as individual parts in a single box. As a result, your bill of materials is considerably shortened and downstream processes such as product ordering, order picking and assembly are significantly simplified.</p> <p>All ordering options are available in the following countries: AT, BE, CH, CZ, DE, DK, ES, EST, FI, FR, GB, GR, HU, IE, IT, NL, NO, PL, PT, RU, SE, SI, SK, TR, ZA.</p> <p>This tool can be found</p> <ul style="list-style-type: none"> at: www.festo.com/fdt-3d-online in the above listed countries.





Piston rod cylinders >

Round cylinders

	 Standards-based cylinders DSNU	 Round cylinders DSNU	 Round cylinders DSNU-S
Operating mode	Double-acting	Double-acting	Double-acting
Piston diameter	8 mm, 10 mm, 12 mm, 16 mm, 20 mm, 25 mm	32 mm, 40 mm, 50 mm, 63 mm	8 mm, 12 mm, 16 mm, 20 mm, 25 mm
Theoretical force at 6 bar, advancing	23 ... 295 N	482.5 ... 1870.3 N	30.2 ... 294.5 N
Stroke	1 ... 500 mm	1 ... 500 mm	1 ... 200 mm
Cushioning	Elastic cushioning rings/plates at both ends, self-adjusting pneumatic end-position cushioning, pneumatic cushioning, adjustable at both ends	Elastic cushioning rings/plates at both ends, self-adjusting pneumatic end-position cushioning, pneumatic cushioning, adjustable at both ends	Elastic cushioning rings/plates at both ends, self-adjusting pneumatic end-position cushioning
Description	<ul style="list-style-type: none"> ISO 6432 Wide range of variants for customised applications Good running performance and long service life Self-adjusting pneumatic end-position cushioning which adapts optimally to changes in load and speed Piston rod with female or male thread For position sensing 	<ul style="list-style-type: none"> Wide range of variants for customised applications Good running performance and long service life Self-adjusting pneumatic end-position cushioning which adapts optimally to changes in load and speed Piston rod with female or male thread For position sensing 	<ul style="list-style-type: none"> Compact variant of standards-based cylinder DSNU Wide range of variants for customised applications Self-adjusting pneumatic end-position cushioning which adapts optimally to changes in load and speed Piston rod with male thread For position sensing
→ Page/online	27	29	31

Piston rod cylinders >





Tie rod and profile barrel cylinders

	 Standards-based cylinders DSBC	 Standards-based cylinders DSBG	 Standards-based cylinders DSBG	 Standards-based cylinders, clean design DSBF-C
Operating mode	Double-acting	Double-acting	Double-acting	Double-acting
Piston diameter	32 mm, 40 mm, 50 mm, 63 mm, 80 mm, 100 mm, 125 mm	32 mm, 40 mm, 50 mm, 63 mm, 80 mm, 100 mm, 125 mm	160 mm, 200 mm, 250 mm, 320 mm	32 mm, 40 mm, 50 mm, 63 mm, 80 mm, 100 mm, 125 mm
Theoretical force at 6 bar, advancing	415 ... 7363 N	415 ... 7363 N	12064 ... 48255 N	415 ... 7363 N
Stroke	1 ... 2800 mm	1 ... 2800 mm	1 ... 2700 mm	1 ... 2800 mm
Cushioning	Elastic cushioning rings/plates at both ends, self-adjusting pneumatic end-position cushioning, pneumatic cushioning, adjustable at both ends	Elastic cushioning rings/plates at both ends, self-adjusting pneumatic end-position cushioning, pneumatic cushioning, adjustable at both ends	Elastic cushioning rings/plates at both ends, pneumatic cushioning adjustable at both ends	Elastic cushioning rings/plates at both ends, self-adjusting pneumatic end-position cushioning, pneumatic cushioning, adjustable at both ends
Description	<ul style="list-style-type: none"> • ISO 15552 (ISO 6431, VDMA 24562) • Self-adjusting pneumatic end-position cushioning which adapts optimally to changes in load and speed • Standard profile with two sensor slots • Wide range of variants for customised applications • Comprehensive range of mounting accessories for just about every type of installation • For position sensing 	<ul style="list-style-type: none"> • ISO 15552 (ISO 6431, VDMA 24562) • Sturdy tie rod design • Self-adjusting pneumatic end-position cushioning which adapts optimally to changes in load and speed • Comprehensive range of mounting accessories for just about every type of installation • For position sensing • Variants to EU Explosion Protection Directive (ATEX) 	<ul style="list-style-type: none"> • ISO 15552 (ISO 6431, VDMA 24562) • Sturdy tie rod design • Pneumatic end-position cushioning adjustable at both ends • Optionally without adjustable pneumatic cushioning at both ends, and position sensing, resulting in a price advantage • Optionally with spacer bolt attachment • For position sensing • Variants to EU Explosion Protection Directive (ATEX) 	<ul style="list-style-type: none"> • ISO 15552 • Increased corrosion protection • Easy-to-clean design • FDA-approved lubrication and sealing on the basic design • Long service life thanks to optional dry-running seal • Self-adjusting pneumatic end-position cushioning which adapts optimally to changes in load and speed • For position sensing
→ Page/online	33	dsbg	dsbg	36

Product overview



Piston rod cylinders >

Compact, short-stroke and flat cylinders

	 Compact cylinders ADN-S	 Compact cylinders AEN-S	 Compact cylinders ADN	 Short-stroke cylinders ADVC, AEVC
Operating mode	Double-acting	Pushing	Double-acting	Double-acting, pushing, single-acting
Piston diameter	6 mm, 10 mm, 12 mm, 16 mm, 20 mm, 25 mm, 32 mm, 40 mm, 50 mm, 63 mm	6 mm, 10 mm, 12 mm, 16 mm, 20 mm, 25 mm, 32 mm, 40 mm, 50 mm, 63 mm	12 mm, 16 mm, 20 mm, 25 mm, 32 mm, 40 mm, 50 mm, 63 mm, 80 mm, 100 mm, 125 mm	4 mm, 6 mm, 10 mm, 12 mm, 16 mm, 20 mm, 25 mm, 32 mm, 40 mm, 50 mm, 63 mm, 80 mm, 100 mm
Theoretical force at 6 bar, advancing	17 ... 1870 N	13 ... 1780	51 ... 7363 N	4.9 ... 4712 N
Stroke	5 ... 50 mm	5 mm, 10 mm, 25 mm	1 ... 500 mm	2.5 ... 25 mm
Cushioning	No cushioning, elastic cushioning rings/plates at both ends	No cushioning, elastic cushioning rings/plates at both ends	Elastic cushioning rings/plates at both ends, self-adjusting pneumatic end-position cushioning	Elastic cushioning rings/plates at both ends
Description	<ul style="list-style-type: none"> Minimal installation space Very lightweight Ideal for small movements Piston rod with female or male thread For position sensing 	<ul style="list-style-type: none"> Minimal installation space Very lightweight Ideal for small movements High forces in a compact size Piston rod with female or male thread For position sensing 	<ul style="list-style-type: none"> ISO 21287 Up to 50% less installation space than comparable standards-based cylinders to ISO 15552 Piston rod with female or male thread Wide range of variants for customised applications For position sensing 	<ul style="list-style-type: none"> Very short overall length High forces in a compact size Piston rod with female or male thread Optimised fitting space and height Mounting hole pattern according to VDMA 24562 as of Ø 32 mm For position sensing via proximity sensor for T-slot and for C-slot
→ Page/online	39	39	43	46



Piston rod cylinders >

Stainless-steel cylinders

	 Round cylinders CRDSNU, CRDSNU-B	 Round cylinders CRDSNU, CRDSNU-B
Operating mode	Double-acting	Double-acting
Piston diameter	12 mm, 16 mm, 20 mm, 25 mm	32 mm, 40 mm, 50 mm, 63 mm
Theoretical force at 6 bar, advancing	68 ... 295 N	483 ... 1870 N
Stroke	1 ... 500 mm	1 ... 500 mm
Cushioning	Elastic cushioning rings/plates at both ends, self-adjusting pneumatic end-position cushioning, pneumatic cushioning, adjustable at both ends	Elastic cushioning rings/plates at both ends, self-adjusting pneumatic end-position cushioning, pneumatic cushioning, adjustable at both ends
Description	<ul style="list-style-type: none"> ISO 6432 Corrosion-resistant against aggressive ambient conditions Easy-to-clean design Long service life thanks to optional unlubricated seal Wide range of variants for customised applications Self-adjusting pneumatic end-position cushioning saves time during assembly and adapts optimally to changes in load and speed For position sensing 	<ul style="list-style-type: none"> Corrosion-resistant against aggressive ambient conditions Easy-to-clean design Long service life thanks to optional unlubricated seal Wide range of variants for customised applications Self-adjusting pneumatic end-position cushioning saves time during assembly and adapts optimally to changes in load and speed For position sensing
→ Page/online	49	49

Rodless cylinders >

Mechanically coupled cylinders

	 Linear drives DGC-K	 Linear drives DGC-G, DGC-GF, DGC-KF
Piston diameter	18 mm, 25 mm, 32 mm, 40 mm, 50 mm, 63 mm, 80 mm	8 mm, 12 mm, 18 mm, 25 mm, 32 mm, 40 mm, 50 mm, 63 mm
Theoretical force at 6 bar, advancing	153 ... 3016 N	30 ... 1870 N
Stroke	1 ... 8500 mm	1 ... 8500 mm
Cushioning	Pneumatic cushioning adjustable at both ends	Elastic cushioning rings/plates at both ends, pneumatic cushioning adjustable at both ends, shock absorber, hard characteristic curve, shock absorber, soft characteristic curve
Position sensing	Via proximity switch	Via proximity switch
Description	<ul style="list-style-type: none"> • Compact design: 30% smaller than the basic design DGC-G • Basic drive without guide, for simple drive functions • Low moving dead weight • Symmetrical design 	<ul style="list-style-type: none"> • Basic design, plain or recirculating ball bearing guide • All settings accessible from one side • Optionally with variable end stops and intermediate position module • Optional: NSF-H1 lubricant for the food zone (see www.festo.com/sp/dgc > "Certificates" tab) • Optional: clamping unit for holding loads
→ Page/online	53	55

Product overview

Software-Tools

01
Pneumatic drives

Mass moment of inertia

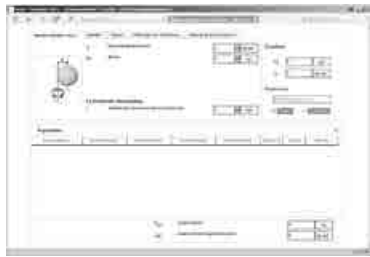

Juggling pencils and pocket calculators is now a thing of the past. Whether you have discs, blocks, push-on flanges, grippers, etc., this tool does the job of calculating all the mass moments of inertia. Just save, send or print and you're finished.

This tool can be found

- on our website at www.festo.com/catalogue by clicking on the blue button 'Engineering'.

Semi-rotary drives >

Semi-rotary drives with rotary vane



**Quarter turn actuators
DRVS**

Size	6, 8, 12, 16, 25, 32, 40
Theoretical torque at 6 bar	0.15 ... 20 Nm
Permissible mass moment of inertia	6.5 ... 350 kgcm ²
Position sensing	Via proximity switch
Swivel angle	0 ... 270°
Description	<ul style="list-style-type: none"> • Double-acting semi-rotary drive with rotary vanes • Lighter than other semi-rotary drives • Fixed swivel angle, adjustable swivel angle possible with the help of accessories • Housing protected against splash water and dust
→ Page/online	58

Semi-rotary drives >

Semi-rotary drives with rack and pinion





**Semi-rotary drives
DRRD**

Size	8, 10, 12, 16, 20, 25, 32, 35, 40, 50, 63
Theoretical torque at 6 bar	0.2 ... 112 Nm
Permissible mass moment of inertia	0.0015 ... 42 kgm ²
Position sensing	Via proximity switch
Swivel angle	180°
Description	<ul style="list-style-type: none"> • Twin-piston rotary drive, power transmission via rack and pinion principle • Extremely accurate in the end positions • Very high load-bearing capacity • Very good axial run-out at the flanged shaft • Greater stability even with smaller sizes
→ Page/online	60

Guided drives >

Drives with slides

	 Mini slides DGST	 Mini slides DGSL
Piston diameter	6 mm, 8 mm, 10 mm, 12 mm, 16 mm, 20 mm, 25 mm	6 mm, 8 mm, 10 mm, 12 mm, 16 mm, 20 mm, 25 mm, 32 mm
Theoretical force at 6 bar, advancing	34 ... 589 N	17 ... 483 N
Stroke	10 ... 200 mm	10 ... 200 mm
Cushioning	Elastomer cushioning, at both ends, stroke not adjustable, elastic cushioning rings/plates at both ends, external hydraulic cushioning	Short elastic cushioning rings/plates at both ends, no cushioning, elastic cushioning rings/plates at both ends with fixed stop, shock absorber, self-adjusting, progressive, at both ends, with reducing sleeve, shock absorber, progressive, at both ends
Position sensing	Via proximity switch	Via proximity switch
Description	<ul style="list-style-type: none"> • Powerful twin-piston drive • Shortest mini slide on the market • Precision recirculating ball bearing guide • Versatile mounting options • Version with symmetrical supply port configuration and sensor slots for compact assembly available to order using the configurator 	<ul style="list-style-type: none"> • High load capacity and positioning accuracy • Maximum movement precision thanks to ground-in ball bearing cage guide • Maximum flexibility thanks to 8 sizes • Reliable in the event of pressure drop thanks to clamping cartridge or end-position locking • Wide variety of mounting and attachment options • Compact design
→ Page/online	62	dgsl

Guided drives >

Drives with guide rods

	 Guided drives DFM, DFM-B
Piston diameter	6 mm, 10 mm, 12 mm, 16 mm, 20 mm, 25 mm, 32 mm, 40 mm, 50 mm, 63 mm, 80 mm, 100 mm
Theoretical force at 6 bar, advancing	17 ... 4712 N
Stroke	5 ... 400 mm
Cushioning	Elastic cushioning rings/plates at both ends, pneumatic cushioning adjustable at both ends, shock absorber, soft characteristic curve
Position sensing	Via proximity switch
Description	<ul style="list-style-type: none"> • Drive and guide unit in a single housing • High resistance to torques and lateral forces • Plain or recirculating ball bearing guide • Wide variety of mounting and attachment options • Wide range of variants for customised applications
→ Page/online	64



Product overview

Software-Tools

01
Pneumatic drives

Feed separator		<p>This tool helps you to select the right separator of the type HPV from Festo for your application. Let yourself be guided by the program – enter the general parameters and you will receive at least one suggestion for the product best suited to your application.</p> <p>This tool can be found</p> <ul style="list-style-type: none"> • on our website at www.festo.com/catalogue by clicking on the blue button "Engineering".
-----------------------	---	---

Feed separators

	 Feed separators HPVS	 Feed separators HPV
Operating mode	Double-acting	Double-acting
Piston diameter	10 mm, 14 mm, 22 mm	10 mm, 14 mm, 22 mm
Stroke	10 ... 60 mm	10 ... 60 mm
Theoretical force at 6 bar, advancing	45 ... 225 N	45 ... 225 N
Description	<ul style="list-style-type: none"> • Version with one plunger • With non-rotating piston rod • Proximity sensor SME/SMT-8 can be integrated in the housing 	<ul style="list-style-type: none"> • Version with two plungers • With twin piston, non-rotating piston rod and locking mechanism • Cost-effective: replaces at least two drives in the feed process • Proximity sensor SME/SMT-8 can be integrated in the housing
→ Page/online	hpvs	hpv



Valve actuators for process automation >

Linear actuators for process automation



	 Linear actuators DFPC	
Design	Piston, piston rod, tie rod, cylinder barrel	
Operating mode	Double-acting	
Size of valve actuator	80, 100, 125	
Stroke	10 ... 1600 mm	
Flange hole pattern	F07, F10	
Operating pressure	0.6 ... 8 bar	
Ambient temperature	-20 ... 80°C	
Description	<ul style="list-style-type: none"> • Robust and corrosion-resistant tie-rod design • Ideal for use in harsh ambient conditions • Numerous configuration options • Variants with fastening interface to ISO 5210 or ISO 15552 with extended tie rods 	
→ Page/online	336	

Valve actuators for process automation >

Quarter turn actuators for process automation

	 Quarter turn actuators DFPD	 Quarter turn actuators DAPS
Design	Rack and pinion	Scotch yoke system
Operating mode	Double-acting, single-acting	Double-acting, single-acting
Size of valve actuator	10, 20, 40, 80, 120, 160, 240, 300, 480, 700, 900, 1200, 2300	0008, 0015, 0030, 0053, 0060, 0090, 0106, 0120, 0180, 0240, 0360, 0480, 0720, 0960, 1440, 1920, 2880, 3840, 4000, 5760, 8000
Flange hole pattern	F03, F04, F05, F07, F10, F12, F14, F16, F0507, F0710, F1012, F1216	F03, F04, F05, F07, F10, F12, F14, F16, F25
Swivel angle	90°, 120°, 135°, 180°	90 ... 92°
Operating pressure	2 ... 8 bar	1 ... 8.4 bar
Ambient temperature	-50 ... 150°C	-50 ... 150°C
Description	<ul style="list-style-type: none"> • Constant torque across the full rotation angle range of 90° with the double-acting version • Process valve connection to ISO 5211 • Mounting hole pattern to VDI/VDE 3845 • Sturdy, non-slip and easy-to-clean aluminium housing • Long service life, low wear • Version with swivel angle 120°, 135°, 180° for the sizes 40, 120, 240, 480, 700, double-acting 	<ul style="list-style-type: none"> • High breakaway torques • Flange hole pattern to ISO 5211 • Mounting hole pattern to VDI/VDE 3845 • Optionally with handwheel as a manual emergency override • Corrosion-resistant, stainless-steel version • To EU Explosion Protection Directive (ATEX)
→ Page/online	338	daps

Cylinder mounting parts and accessories for pneumatic drives

	 Mounting attachments	 Piston-rod attachments
Description	<ul style="list-style-type: none"> • Mounting kits • Direct mountings • Foot mountings • Flange mountings • Swivel mountings • Clevis feet, trunnion supports • Slot nuts • Centring pins/sleeves 	<ul style="list-style-type: none"> • Rod clevises SG, CRSG • Rod eyes SGS • Coupling pieces KSG • Self-aligning rod couplers FK • Adapters AD
→ Page/online	n_015001	66

Product overview

Software-Tools

01
Pneumatic drives

Product Finder for grippers



A secure grip is a question of the right calculation. In this case, calculation of weight, direction of movement, distances, etc.

The software tool immediately determines which type of gripper - parallel, three-point, angle or swivel/gripper - and which size best matches your requirements.

This tool can be found

- on our website at www.festo.com/catalogue by clicking on the blue button "Product Finder".

Grippers › Mechanical grippers ›

Parallel grippers



Parallel grippers
DHPS



Parallel grippers
HGPT





Parallel grippers
HGPL-B

Size	6, 10, 16, 20, 25, 35	16, 20, 25, 35, 40, 50, 63, 80	14, 25, 40, 63
Stroke per gripper jaw	2 ... 12.5 mm	1.5 ... 25 mm	20 ... 150 mm
Total gripping force at 6 bar, closing	25 ... 910 N	106 ... 6300 N	158 ... 2742 N
Gripping force backup	During opening, during closing	During opening, during closing	
Gripper repetition accuracy	<0.02 mm	≤0.05 mm	<0.03 mm
Position sensing	Via Hall sensor, via proximity sensor	Via proximity switch	Via proximity switch
Description	<ul style="list-style-type: none"> • Heavy-duty, precision T-slot guide for gripper jaws • High gripping force and compact size • Max. repetition accuracy • Wide range of adaptation options on the drives 	<ul style="list-style-type: none"> • Sturdy and powerful • With T-slot guide • Suitable for external and internal gripping • Gripper jaw guide protected by sealing air against dust • High-force variant available 	<ul style="list-style-type: none"> • Space-saving, high forces and torques • Controlled, precise and centred gripping • Long stroke: long guide length for the gripper jaws • Suitable for external and internal gripping • Opening stroke can be adjusted to optimise time
→ Page/online	dhps	hgpt	hgpl

Grippers > Mechanical grippers >

Three-point grippers

	 Three-point grippers DHDS	 Three-point grippers HGDT
Size	16, 32, 50	25, 35, 40, 50, 63
Stroke per gripper jaw	2.5 ... 6 mm	1.5 ... 10 mm
Total gripping force at 6 bar, closing	87 ... 750 N	207 ... 2592 N
Gripping force backup	During closing	During opening, during closing
Gripper repetition accuracy	≤0.04 mm	≤0.03 mm
Position sensing	Via Hall sensor, via proximity sensor	Via proximity switch
Description	<ul style="list-style-type: none"> • Heavy-duty, precision T-slot guide for gripper jaws • High gripping force and compact size • Max. repetition accuracy • Wide range of adaptation options on the drives 	<ul style="list-style-type: none"> • Synchronous movement of the gripper jaws • With T-slot guide • Suitable for external and internal gripping • Gripper jaw guide protected by sealing air against dust • High-force variant available
→ Page/online	dhds	hgdt

Grippers > Mechanical grippers >

Angle grippers

	 Angle grippers DHWS
Size	10, 16, 25, 32, 40
Total gripping torque at 6 bar, closing	30 ... 1362 Ncm
Max. opening angle	40°
Gripping force backup	During closing
Gripper repetition accuracy	≤0.04 mm
Position sensing	Via Hall sensor, via proximity sensor
Description	<ul style="list-style-type: none"> • Improved gripper jaw guide • Slotted guide • Internal fixed flow control, does away with the need for external flow control in 90% of applications • Max. repetition accuracy • Wide range of adaptation options on the drives
→ Page/online	dhws

Product overview

Grippers > Mechanical grippers >

Radial grippers



Radial grippers
DHRS

Size	10, 16, 25, 32, 40
Total gripping torque at 6 bar, closing	15 ... 660 Ncm
Max. opening angle	180°
Gripping force backup	During closing
Gripper repetition accuracy	≤0.1 mm
Position sensing	Via Hall sensor, via proximity sensor
Description	<ul style="list-style-type: none"> • Lateral gripper jaw support for high torque loads • Self-centring • Gripper jaw centring options • Max. repetition accuracy
→ Page/online	dhrs

Customised components – for your specific requirements



Drives with customised designs

Can't find the pneumatic drive you need in our catalogue?

We can offer you customised components that are tailored to your specific requirements.

Common product modifications:

- Materials for special ambient conditions
- Customised dimensions
- Special strokes
- Customised mounting options
- Implementation of special cylinder functions (cylinder/valve combinations, single-acting principle, etc.)

Many additional variants are possible.

Ask your Festo sales engineer, who will be happy to help:

→ www.festo.com/contact

Self-adjusting end-position cushioning PPS for standards-based cylinders

More productivity, less work: PPS

Simply ingenious: the unique, self-adjusting end-position cushioning PPS saves huge amounts of time during assembly, adjusts optimally to changes in load and speed and allows the cylinder to move dynamically and gently into the end position. This reduces wear on the entire system.

This and many other advantages are the result of the unique design with longitudinal slots which allow air to escape.

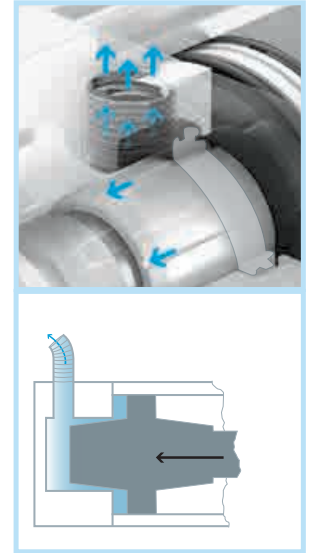
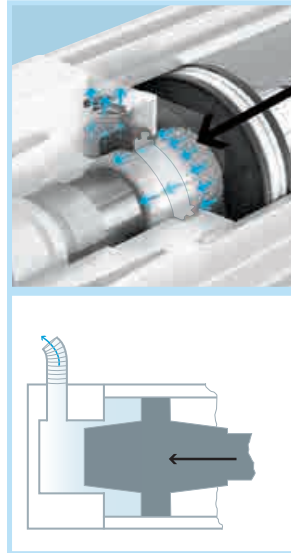
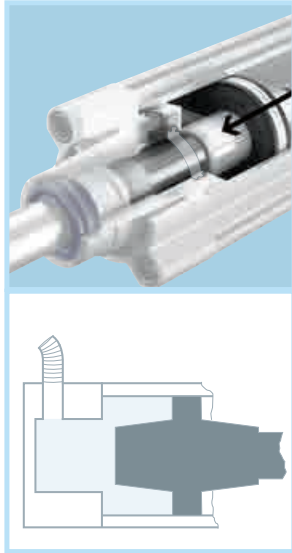

Use the advantages of PPS – in these cylinders

DSNU
→ 27

DSNU-S
→ 31

DSBC
→ 33

ADN
→ 43

CRDSNU
→ 49



Software tool

Festo Design Tool 3D

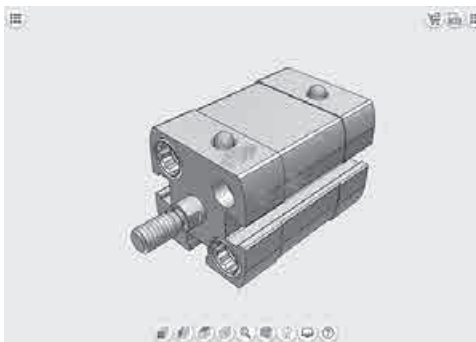

The Festo Design Tool 3D is a 3D product configurator for generating specific CAD product combinations from Festo. The configurator makes your search for the right accessory easier, more reliable and faster.

You can then order the module that has been created as a single order item, either completely pre-assembled or as individual parts in a single box. As a result, your bill of materials is considerably shortened and downstream processes such as product ordering, order picking and assembly are significantly simplified.

All ordering options are available in the following countries:
AT, BE, CH, CZ, DE, DK, ES, EST, FI, FR, GB, GR, HU, IE, IT, NL, NO, PL, PT, RU, SE, SI, SK, TR, ZA.

This tool can be found

• at: www.festo.com/fdt-3d-online in the above listed countries.

Self-adjusting end-position cushioning PPS for standards-based cylinders

Less can be more: the advantages of self-adjusting cushioning at a glance



Less shock

Running smoothly, Part 1:
The better the cushioning, the less settling and impact vibration. Better for the cylinder, better for the machine.



Less time

Save time and effort in adjusting. The calculation is simple:
no. of cylinders x 5 mins = big cost saving.



Less noise

Running smoothly, Part 2:
Where there is no vibration, there is nothing to disturb the working environment of both workers and machines.



Less errors

Always correct. All by itself. PPS cushioning prevents setting errors and automatically compensates for changing loads.



Less adjustment required:

Goodbye screwdriver. Not just less adjustment, but no adjustment at all! Standards-based cylinders with PPS cushioning are self-adjusting.

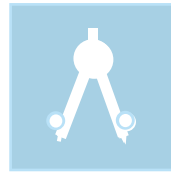

Less planning

Making it easy – setting multiple cylinders to run in parallel is a nightmare. Standards-based cylinders with PPS cushioning. Simply fit and forget.



Less cleaning

A clean solution. No cushioning screws cuts dust and dirt traps and makes for smoother surfaces. In other words, adjusting-screw-free.



Less bulky

Compact cylinders ADN-PPS offer up to 300% more end of stroke energy absorption. Smaller or more powerful, the choice is yours.



Less variants

Relaxed purchasing. Cylinders with PPS cushioning have a far wider operating range than most standard cylinders. The result is fewer variants with more application options.



Less risk

No screws, no setting on live machinery; safer and faster. And no operator fiddling. Standards-based cylinders with PPS are self-adjusting.



Less wear

Self-adjusting means always perfectly set. Perfectly set cushioning means that cylinders operate more smoothly and longer. More machine uptime and greater throughput.



Less stock

Less is more. Your finance department will think so too. PPS cushioning enables a narrower range of cylinders to cover the same performance range. And less stock = lower costs.

Standards-based cylinders DSNU, to ISO 6432, double-acting

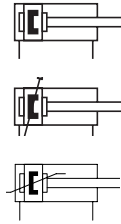

- Diameter 8 ... 25 mm: ISO 6432
- For very high demands on running characteristics, service life and load capacity
- Universal use thanks to individual variants
- Comprehensive range of accessories
- Selected types in accordance with ATEX directive for potentially explosive atmospheres
→ www.festo.com/ex

Order code – Basic design



Legend: Mandatory entry Optional entry

001	Type
DSNU	Double-acting standards-based cylinder
002	Piston Ø [mm]
...	8, 10, 12, 16, 20, 25
003	Stroke [mm]
...	10, 15, 20, 25, 30, 35, 40, 50, 60, 70, 80, 100, 125, 150, 160, 200, 250, 300, 320

004	Cushioning
P	Elastic cushioning rings/plates at both ends
PPV	Pneumatic cushioning adjustable at both ends
PPS	Pneumatic cushioning, self-adjusting at both ends
005	Position sensing
-	None
A	Via proximity switch

Product options

1 ... 500 mm Variable stroke	Q	With protection against rotation	KP	With clamping unit	K6	Shortened male piston rod thread
MQ Alternative plain cylinder end cap, lateral connection	S2	Through piston rod	K2	Extended male piston rod thread	K8	Extended piston rod
MA Alternative plain cylinder end cap, axial connection	S6	Heat-resistant seals up to max. 120 °C	K3	Female piston rod thread	R3	High corrosion protection
MH Alternative cylinder end cap, direct mounting	S10	Slow speed	K5	Special piston rod thread	R8	Dust protection (scraper)
	S11	Low friction			A6	Metal scraper
					KP	Clamping unit on the piston rod

Configurable product

This product and all its product options can be ordered online via the configurator:
 → www.festo.com/catalogue/...
 Enter the part number or the type.

Part no.	Type	Stroke [mm]	Part no.	Type	Stroke [mm]
193986	DSNU-8-...-P	1 ... 100	14326	DSNU-8-...-P-A	10 ... 100
193987	DSNU-10-...-P	1 ... 100	14325	DSNU-10-...-P-A	10 ... 100
193988	DSNU-12-...-P/-PPV	1 ... 200	14324	DSNU-12-...-P-A	10 ... 200
193989	DSNU-16-...-P/-PPV/-PPS	1 ... 200	14323	DSNU-16-...-P-A	10 ... 200
193990	DSNU-20-...-P/-PPV/-PPS	1 ... 320	14328	DSNU-20-...-P-A	10 ... 320
193991	DSNU-25-...-P/-PPV/-PPS	1 ... 500	14327	DSNU-25-...-P-A	10 ... 500
			14320	DSNU-16-...-PPV-A	10 ... 200
			14321	DSNU-20-...-PPV-A	10 ... 320
			14322	DSNU-25-...-PPV-A	10 ... 500

Piston rod cylinders > Round cylinders >

Standards-based cylinders DSNU, to ISO 6432, double-acting

Ordering – Basic design

003 Stroke [mm]	002 Piston Ø [mm]						002 Piston Ø [mm]			002 Piston Ø [mm]		
	8	10	12	16	20	25	16	20	25	16	20	25
	004 Cushioning – 005 Position sensing						004 Cushioning – 005 Position sensing			004 Cushioning – 005 Position sensing		
	P – A	P – A	P – A	P – A	P – A	P – A	PPV – A	PPV – A	PPV – A	PPS – A	PPS – A	PPS – A
10	19177	19183	19189	19198	19207	19218	1908266	1908289	1908312	1908274	1908297	1908320
15	1908247	1908251	1908255	1908259	1908282	1908305	1908267	1908290	1908313	1908275	1908298	1908321
20	1908248	1908252	1908256	1908260	1908283	1908306	1908268	1908291	1908314	1908276	1908299	1908322
25	19178	19184	19190	19199	19208	19219	33973	33974	33975	559263	559271	559282
30	1908249	1908253	1908257	1908261	1908284	1908307	1908269	1908292	1908315	1908277	1908300	1908323
35				1908262	1908285	1908308	1908270	1908293	1908316	1908278	1908301	1908324
40	19179	19185	19191	19200	19209	19220	19229	19236	19245	559264	559272	559283
50	19180	19186	19192	19201	19210	19221	19230	19237	19246	559265	559273	559284
60	1908250	1908254	1908258	1908263	1908286	1908309	1908271	1908294	1908317	1908279	1908302	1908325
70				1908264	1908287	1908310	1908272	1908295	1908318	1908280	1908303	1908326
80	19181	19187	19193	19202	19211	19222	19231	19238	19247	559266	559274	559285
100	19182	19188	19194	19203	19212	19223	19232	19239	19248	559267	559275	559286
125			19195	19204	19213	19224	19233	19240	19249	559268	559276	559287
150			5249947	1908265	1908288	1908311	1908273	1908296	1908319	1908281	1908304	1908327
160			19196	19205	19214	19225	19234	19241	19250	559269	559277	559288
200			19197	19206	19215	19226	19235	19242	19251	559270	559278	559289
250						19216	19227		19243	19252	559279	559290
300						19217	19228		19244	19253	559280	559291
320						34718	34719		34720	34721	559281	559292

Accessories

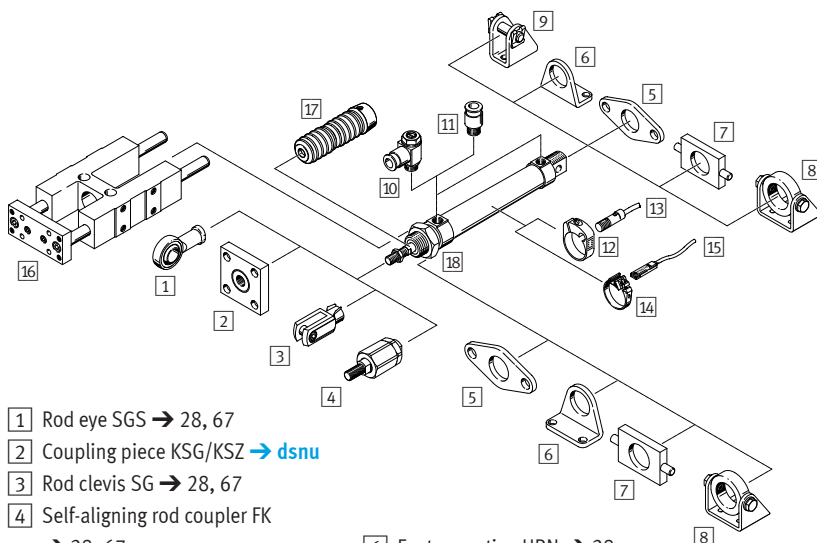

- 1 Rod eye SGS → 28, 67
- 2 Coupling piece KSG/KSZ → dsnu
- 3 Rod clevis SG → 28, 67
- 4 Self-aligning rod coupler FK → 28, 67
- 5 Flange mounting FBN → 28

- 6 Foot mounting HBN → 28
- 7 Swivel mounting WBN → 28

- 8 Swivel mounting SBN → 28
- 9 Clevis foot LBN → 28
- 10 One-way flow control valve GRLA/ GRLZ → 192
- 11 Push-in fitting QS → 293
- 12 Mounting kit SMBR → dsnu
- 13 Proximity sensor SMEO-/SMT0-4U → dsnu
- 14 Mounting kit SMBR-8 → 224
- 15 Proximity sensor SMT-8M → 223
- 16 Guide unit FEN → dsnu
- 17 Bellows kit DADB → dsnu
- 18 Hex nut MSK → 28

1 Rod eye SGS		
For Ø	Type	Part no.
8, 10	SGS-M4	9253

3 Rod clevis SG		
For Ø	Type	Part no.
8, 10	SG-M4	6532

4 Self-aligning rod coupler FK		
For Ø	Type	Part no.
8, 10	FK-M4	6528

5 Flange mounting FBN		
For Ø	Type	Part no.
8, 10	FBN-8/10	5129
12, 16	FBN-12/16	5130
20, 25	FBN-20/25	5131

6 Foot mounting HBN ¹⁾		
For Ø	Type	Part no.
8, 10	HBN-8/10x1	5123
	HBN-8/10x2	5124
12, 16	HBN-12/16x1	5125
	HBN-12/16x2	5126
20, 25	HBN-20/25x1	5127
	HBN-20/25x2	5128

1) ...x1: . 1x foot; ...x2: 2x foot, 1x nut

7 Swivel mounting WBN		
For Ø	Type	Part no.
8, 10	WBN-8/10	8608
12, 16	WBN-12/16	8609
20, 25	WBN-20/25	8610

8 Swivel mounting SBN		
For Ø	Type	Part no.
20, 25	SBN-20/25	539927

9 Clevis foot LBN		
For Ø	Type	Part no.
8, 10	LBN-8/10	6057
12, 16	LBN-12/16	6058
20, 25	LBN-20/25	6059

18 Hex nut MSK		
For Ø	Type	Part no.
16	MSK-M16x1,5	189007
20, 25	MSK-M22x1,5	189009

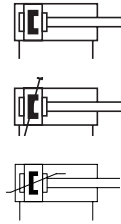

- For very high demands on running characteristics, service life and load capacity
- Universal use thanks to individual variants
- Comprehensive range of accessories

- Selected types in accordance with ATEX directive for potentially explosive atmospheres

→ www.festo.com/ex

Order code – Basic design

001 002 003 004 005
DSNU - - - - - **A**

Legend: Mandatory entry

001	Type
DSNU	Double-acting round cylinder
002	Piston Ø [mm]
...	32, 40
003	Stroke [mm]
...	10, 15, 20, 25, 30, 40, 50, 60, 70, 80, 100, 125, 150, 160, 200, 250, 300, 320

004	Cushioning
P	Elastic cushioning rings/plates at both ends
PPV	Pneumatic cushioning adjustable at both ends
PPS	Pneumatic cushioning, self-adjusting at both ends
005	Position sensing
A	Via proximity switch

Product options

50, 63 mm Piston Ø	Q	With protection against rotation	KP	With clamping unit	K6	Shortened male piston rod thread
1 ... 500 mm Variable stroke	S2	Through piston rod	K2	Extended male piston rod thread	K8	Extended piston rod
MQ Alternative plain cylinder end cap, lateral connection	S6	Heat-resistant seals up to max. 120 °C	K3	Female piston rod thread	R3	High corrosion protection
MA Alternative plain cylinder end cap, axial connection	S10	Slow speed	K5	Special piston rod thread	R8	Dust protection (scraper)
MH Alternative cylinder end cap, direct mounting	S11	Low friction			A6	Metal scraper
					KP	Clamping unit on the piston rod

Configurable product

This product and all its product options can be ordered online via the configurator:

→ www.festo.com/catalogue/...

Enter the part number or the type.

Part no.	Type
193992	DSNU-32-...
193993	DSNU-40-...
193994	DSNU-50-...
193995	DSNU-63-...

Piston rod cylinders > Round cylinders >
Round cylinders DSNU, double-acting

Ordering – Basic design

003 Stroke [mm]	002 Piston Ø [mm]		002 Piston Ø [mm]		002 Piston Ø [mm]	
	32	40	32	40	32	40
	004 Cushioning – 005 Position sensing		004 Cushioning – 005 Position sensing		004 Cushioning – 005 Position sensing	
	P – A	P – A	PPV – A	PPV – A	PPS – A	PPS – A
10	5249365	5262529				
15	5249366	5262530				
20	5249367	5262531				
25	195980	195990	196020	196030	559295	559305
30	5249368	5262532	5249851	5262705	5249968	5262768
40	195981	195991	196021	196031	559296	559306
50	195982	195992	196022	196032	559297	559307
60	5249369	5262534	5249853	5262706	5249970	5262769
70	5249370	5262535	5249854	5262707	5249971	5262771
80	195983	195993	196023	196033	559298	559308
100	195984	195994	196024	196034	559299	559309
125	195985	195995	196025	196035	559300	559310
150	5249371	5262536	5249855	5262708	5249972	5262772
160	195986	195996	196026	196036	559301	559311
200	195987	195997	196027	196037	559302	559312
250	195988	195998	196028	196038	559303	559313
300	5249372	5262537	5249856	5262709	5249973	5262773
320	195989	195999	196029	196039	559304	559314

Accessories

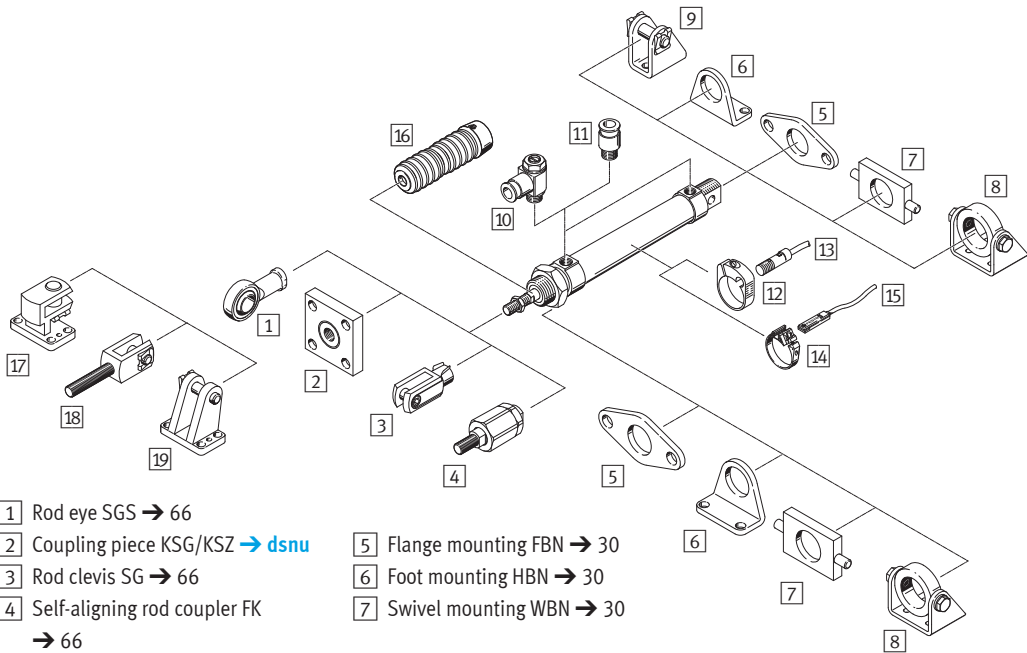

- 1 Rod eye SGS → 66
- 2 Coupling piece KSG/KSZ → dsnu
- 3 Rod clevis SG → 66
- 4 Self-aligning rod coupler FK → 66
- 5 Flange mounting FBN → 30
- 6 Foot mounting HBN → 30
- 7 Swivel mounting WBN → 30

- 8 Swivel mounting SBN → 30
- 9 Clevis foot LBN → 30
- 10 One-way flow control valve GRLA/GRLZ → 193
- 11 Push-in fitting QS → 293
- 12 Mounting kit SMBR → dsnu
- 13 Proximity switch SMEO-/SMTO-4U → dsnu
- 14 Mounting kit SMBR-8 → 224
- 15 Proximity switch SMT-8M → 223
- 16 Bellows kit DADB → dsnu
- 17 Right-angle clevis foot LQG → 30
- 18 Rod clevis SGA → 30
- 19 Clevis foot LBG → 30

5 Flange mounting FBN		
For Ø	Type	Part no.
32	FBN-32	195855
40	FBN-40	195856

7 Swivel mounting WBN		
For Ø	Type	Part no.
32	WBN-32	195863
40	WBN-40	195864

9 Clevis foot LBN		
For Ø	Type	Part no.
32	LBN-32	195860
40	LBN-40	195861

18 Rod clevis SGA		
For Ø	Type	Part no.
32	SGA-M10x1,25	32954
40	SGA-M12x1,25	10767

6 Foot mounting HBN ¹⁾		
For Ø	Type	Part no.
32	HBN-32x2	195851
40	HBN-40x2	195852

8 Swivel mounting SBN		
For Ø	Type	Part no.
32	SBN-32	539924
40	SBN-40	539925

17 Right-angle clevis foot LQG		
For Ø	Type	Part no.
32	LQG-32	31768
40	LQG-40	31769

19 Clevis foot LBG		
For Ø	Type	Part no.
32	LBG-32	31761
40	LBG-40	31762

1) ...x2: 2x foot, 1x nut

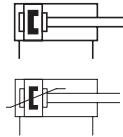

- Compact variant of standards-based cylinder DSNU
- Piston Ø 8... 25 mm
- Stroke 10 ... 200 mm

Order code – Basic design

001 002 003 004 005 006
DSNU - **S** - - - - **A**

Legend: Mandatory entry

001	Type
DSNU	Double-acting round cylinder
002	Design
S	Compact
003	Piston Ø [mm]
...	8, 12, 16, 20, 25

004	Stroke [mm]
...	10, 15, 20, 25, 30, 40, 50, 60, 80, 100, 125, 150, 200
005	Cushioning
P	Elastic cushioning rings/plates at both ends
PPS	Pneumatic cushioning, self-adjusting at both ends
006	Position sensing
A	Via proximity switch

Product options

1 ... 200 mm Variable stroke

Configurable product

This product and all its product options can be ordered online via the configurator:

→ www.festo.com/catalogue/...

Enter the part number or the type.

Part no.	Type	Part no.	Type
8112002	DSNU-S-8...	8112005	DSNU-S-20...
8112003	DSNU-S-12...	8112006	DSNU-S-25...
8112004	DSNU-S-16...		

Piston rod cylinders > Round cylinders >

Round cylinders DSNU-S, double-acting

Ordering – Basic design

004 Stroke [mm]	003 Piston Ø [mm]					003 Piston Ø [mm]		
	8	12	16	20	25	16	20	25
	005 Elastic cushioning rings/plates at both ends – 006 Position sensing					005 Pneumatic cushioning, self-adjusting at both ends – 006 Position sensing		
	P – A	P – A	P – A	P – A	P – A	PPS – A	PPS – A	PPS – A
10	5205897	5211896	5216087	5224633	5228227			
15	5205898	5211897	5216088	5224634	5228228			
20	5205899	5211898	5216089	5224635	5228229			
25	5205900	5211899	5216090	5224636	5228230	5217238	5225836	5228452
30	5205902	5211900	5216091	5224637	5228231	5217239	5225837	5228453
40	5205903	5211901	5216093	5224639	5228232	5217240	5225838	5228454
50	5205904	5211903	5216094	5224641	5228233	5217241	5225839	5228455
60	5205905	5211904	5216095	5224642	5228234	5217242	5225840	5228456
80	5205906	5211905	5216096	5224643	5228235	5217243	5225841	5228457
100	5205907	5211906	5216098	5224644	5228236	5217244	5225842	5228458
125		5211908	5216099	5224645	5228237	5217245	5225843	5228459
150		5211909	5216100	5224646	5228238	5217246	5225844	5228460
200			5216101	5224647	5228239	5217248	5225846	5228461

Accessories

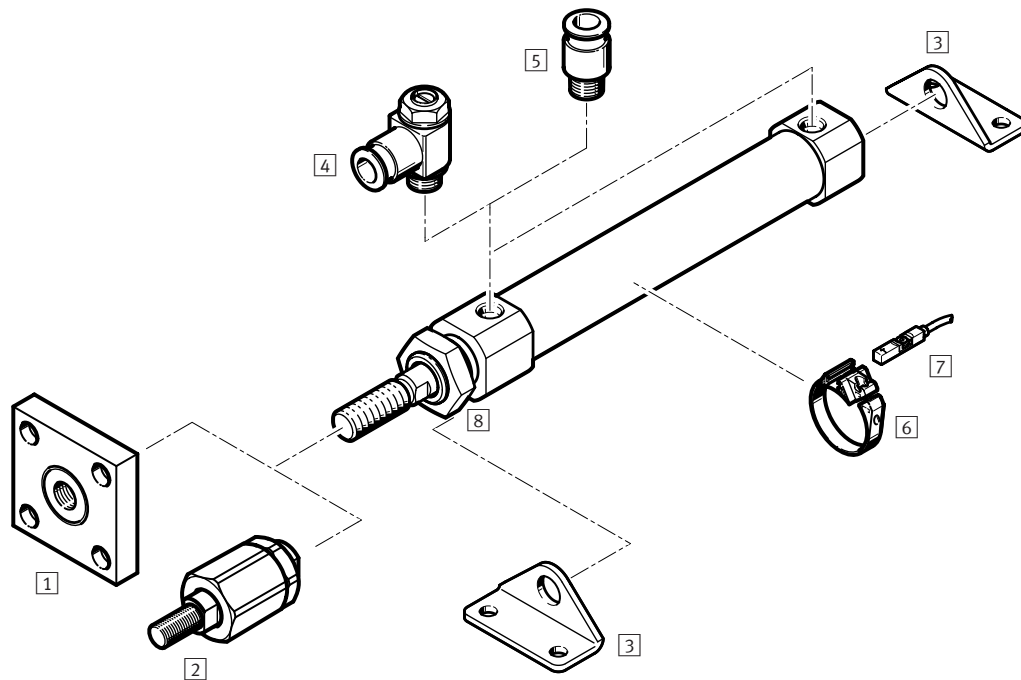

- 1 Coupling piece KSG/KSZ → 32
- 2 Self-aligning rod coupler FK → 32
- 3 Foot mounting HBN-S → 32
- 4 One-way flow control valve GRLA/ GRLZ → 192
- 5 Push-in fitting QS → 293
- 6 Mounting kit SMBR-8 → 32
- 7 Proximity sensor SMT-8M → 223
- 8 Hex nut MSK → 32

1 Coupling piece KSG		
For Ø	Type	Part no.
25	KSG-M10x1,25	32963

1 Coupling piece KSZ		
For Ø	Type	Part no.
12, 16	KSZ-M6	36123
20	KSZ-M8	36124
25	KSZ-M10x1,25	36125

2 Self-aligning rod coupler FK		
For Ø	Type	Part no.
8	FK-M4	6528
12, 16	FK-M6	2061
20	FK-M8	2062
25	FK-M10x1,25	6140

3 Foot mounting HBN-S ¹⁾		
For Ø	Type	Part no.
8	HBN-S-8x1	5407712
12, 16	HBN-S-12/16x1	5407772
20, 25	HBN-S-20/25x1	5407787
	HBN-S-20/25x2	5407847

1) ...x1: 1x foot; ...x2: 2x foot, 1x nut

6 Mounting kit SMBR-8		
For Ø	Type	Part no.
8	SMBR-8-8	175091
12	SMBR-8-12	175093
16	SMBR-8-16	175094
20	SMBR-8-20	175095
25	SMBR-8-25	175096
Heat-resistant design		
8 ... 25	SMBR-8-8/100-S6	538937

8 Hex nut MSK		
For Ø	Type	Part no.
16	MSK-M16x1,5	189007
20, 25	MSK-M22x1,5	189009

Standards-based cylinders DSBC, to ISO 15552, double-acting

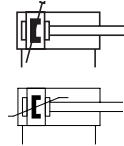

- Strokes of up to 2800 mm
- Excellent flexibility thanks to wide range of variants
- Extensive range of accessories makes it possible to install the cylinder virtually anywhere

- Selected types in accordance with ATEX directive for potentially explosive atmospheres

→ www.festo.com/ex

Order code – Basic design

001	002	003	004	005	006	007	008	009	010
DSBC								A	N3

Legend: Mandatory entry Optional entry

001	Type
DSBC	Double-acting standards-based cylinder
002	Protection against rotation
–	Without protection against rotation
003	Running characteristics
–	Standard
004	Piston Ø [mm]
...	32, 40, 50, 63, 80
005	Stroke [mm]
...	20, 25, 30, 40, 50, 60, 70, 80, 100, 125, 150, 160, 200, 250, 300, 320, 400, 500
006	Piston rod type
–	At one end

007	Piston rod thread type
–	Male thread
008	Cushioning
PPV	Pneumatic cushioning, adjustable at both ends
PPS	Pneumatic cushioning, self-adjusting at both ends
009	Position sensing
A	Via proximity switch
010	Standard
N3	Conforms to ISO 15552

Product options

100, 125 mm Piston Ø	E1	End-position locking at both ends	D3	Sensor slot on 3 sides	A1	Increased chemical resistance
1 ... 2800 mm Variable stroke			P	Elastic cushioning rings/plates both ends	A2	Hard scraper
Q With protection against rotation	E2	End-position locking with advanced piston rod	R3	High corrosion protection	A3	Suitable for unlubricated operation
L Running characteristic low friction	E3	End-position locking with retracted piston rod	T1	Heat-resistant seals up to max. 120 °C	A6	Metal scraper
U Constant, slow movement	T	Through piston rod	T3	Low temperature	EX4	EU certification (II 2GD)
L1 Low friction for balancer applications	F	Female piston rod thread	T4	Heat-resistant seals up to max. 150 °C	...E	Extended piston rod
C Clamping unit attached			P2	Bellows on bearing cap	...L	Extended piston rod thread
						Standard: based on ISO 15552

 Configurable product

This product and all its product options can be ordered online via the configurator:

→ www.festo.com/catalogue/...

Enter the part number or the type.

Part no.	Type	Part no.	Type
1463250	DSBC-...-32-...-A-...	1463495	DSBC-...-80-...-A-...
1461995	DSBC-...-40-...-A-...	1463520	DSBC-...-100-...-A-...
1463770	DSBC-...-50-...-A-...	1722457	DSBC-...-125-...-A-...
1463475	DSBC-...-63-...-A-...		

Piston rod cylinders > Tie rod and profile barrel cylinders >
Standards-based cylinders DSBC, to ISO 15552, double-acting

Ordering – Basic design

005 Stroke [mm]	004 Piston Ø [mm]					004 Piston Ø [mm]				
	32	40	50	63	80	32	40	50	63	80
	008 Pneumatic cushioning, adjustable at both ends – 009 Position sensing					008 Pneumatic cushioning, self-adjusting at both ends – 009 Position sensing				
	PPV A	PPV A	PPV A	PPV A	PPV A	PPS A	PPS A	PPS A	PPS A	PPS A
20	2123069	2123166	2098969	2125490	2126594	2123085	2123780	2102628	2126684	2126636
25	1376422	1376656	1366948	1383578	1383333	1376467	1376903	1376301	1383632	1383366
30	2123070	2123167	2098970	2125491	2126595	2123086	2123781	2102629	2126685	2126637
40	1376423	1376657	1366949	1383579	1383334	1376468	1376904	1376304	1383633	1383367
50	1376424	1376658	1366950	1383580	1383335	1376469	1376905	1376305	1383634	1383368
60	2123071	2123224	2098972	2125492	2126597	2123087	2123782	2102630	2126686	2126638
70	2123072	2123225	2098973	2125493	2126598	2123088	2123783	2102631	2126687	2126639
80	1376425	1376659	1366951	1383581	1383336	1376470	1376906	1376306	1383635	1383369
100	1376426	1376660	1366952	1383582	1383337	1376471	1376907	1376307	1383636	1383370
125	1376427	1376661	1366953	1383583	1383338	1376472	1376908	1376308	1383637	1383371
150	2123073	2123226	2098974	2125494	2126599	2123089	2123784	2102632	2126688	2126640
160	1376428	1376662	1366954	1383584	1383339	1376473	1376909	1376309	1383638	1383372
200	1376429	1376663	1366955	1383585	1383340	1376474	1376910	1376310	1383639	1383373
250	1376430	1376664	1366956	1383586	1383341	1376475	1376911	1376311	1383640	1383374
300	2123074	2123227	2098975	2125495	2126600	2123090	2123785	2102633	2126689	2126641
320	1376431	1376665	1366957	1383587	1383342	1376476	1376912	1376312	1383641	1383375
400	1376432	1376666	1366958	1383588	1383343	1376477	1376913	1376313	1383642	1383376
500	1376433	1376667	1366959	1383589	1383344	1376478	1376914	1376314	1383643	1383377

Accessories

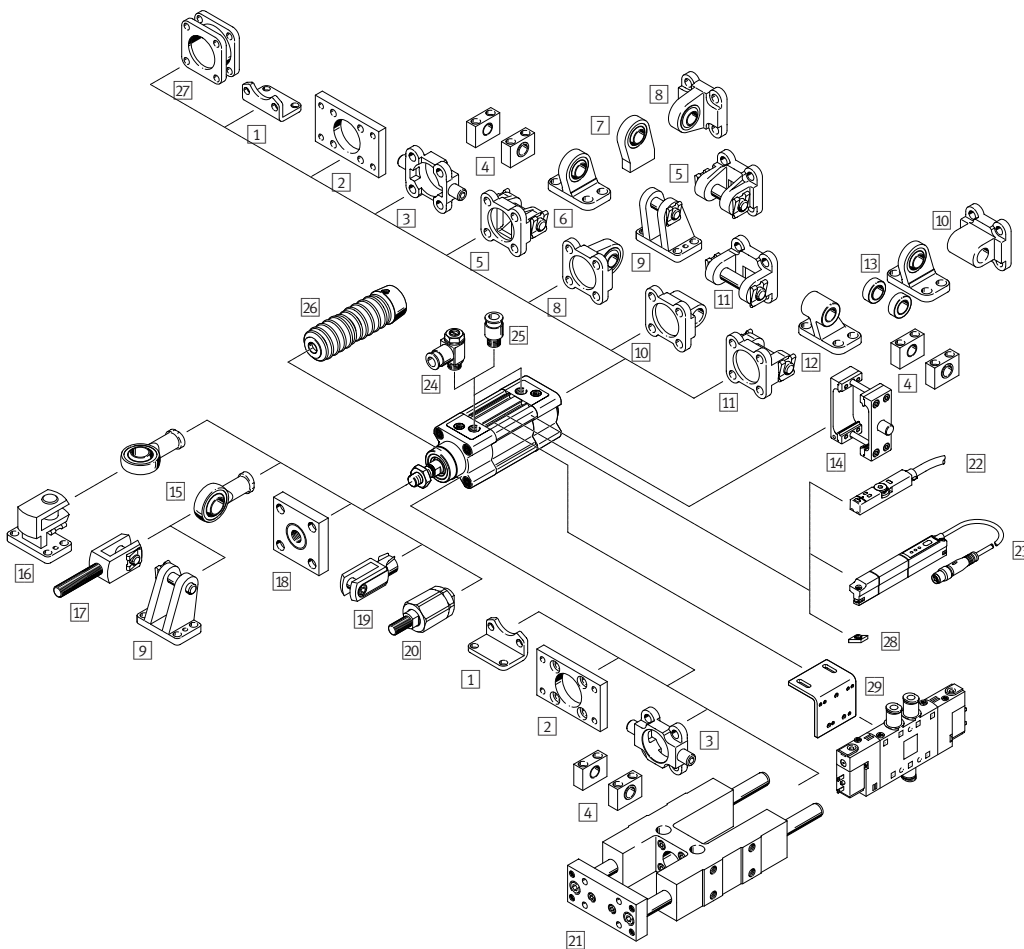

- 1 Foot mounting HNC → 35
- 2 Flange mounting FNC → 35
- 3 Trunnion flange ZNCF → 35
- 4 Trunnion support LNZG → 35
- 5 Swivel flange SNC → 35
- 6 Clevis foot LSNG → dsbc
- 7 Clevis foot LSNSG → dsbc
- 8 Swivel flange SNCS → 35
- 9 Clevis foot LBG → dsbc
- 10 Swivel flange SNCL → 35
- 11 Swivel flange SNCB → 35
- 12 Clevis foot LNG → 35
- 13 Clevis foot LSN → dsbc
- 14 Trunnion mounting kit DAMT → 35
- 15 Rod eye SGS → 67
- 16 Right-angle clevis foot LQG → 35
- 17 Rod clevis SGA → 35
- 18 Coupling piece KSG/KSZ → dsbc
- 19 Rod clevis SG → 67
- 20 Self-aligning rod coupler FK → 67
- 21 Guide unit FENG → dsbc
- 22 Proximity sensor SMT-8M → 223
- 23 Position transmitter SMAT, SDAT → dsbc

24 One-way flow control valve GRLA → 192

26 Bellows kit DADB → dsbc

28 Slot nut ABAN → dsbc

Slot cover ABP-5-S → dsbc

25 Push-in fitting QS → 293

27 Multi-position kit DPNC → 35

29 Mounting kit DAVM → dsbc

Accessories

1 Foot mounting HNC/CRHNC¹⁾

For Ø	Type	Part no.	Type	Part no.
32	HNC-32	174369	CRHNC-32	176937
40	HNC-40	174370	CRHNC-40	176938
50	HNC-50	174371	CRHNC-50	176939
63	HNC-63	174372	CRHNC-63	176940
80	HNC-80	174373	CRHNC-80	176941

1) CRHNC: high corrosion protection

2 Flange mounting FNC/CRFNG²⁾

For Ø	Type	Part no.	Type	Part no.
32	FNC-32	174376	CRFNG-32	161846
40	FNC-40	174377	CRFNG-40	161847
50	FNC-50	174378	CRFNG-50	161848
63	FNC-63	174379	CRFNG-63	161849
80	FNC-80	174380	CRFNG-80	161850

2) CRFNG: high corrosion protection

3 Trunnion flange ZNCF

For Ø	Type	Part no.
32	ZNCF-32	174411
40	ZNCF-40	174412
50	ZNCF-50	174413
63	ZNCF-63	174414
80	ZNCF-80	174415

4 Trunnion support LNZG

For Ø	Type	Part no.
32	LNZG-32	32959
40	LNZG-40/50	32960
50	LNZG-40/50	32960
63	LNZG-63/80	32961
80	LNZG-63/80	32961

5 Swivel flange SNC

For Ø	Type	Part no.
32	SNC-32	174383
40	SNC-40	174384
50	SNC-50	174385
63	SNC-63	174386
80	SNC-80	174387

8 Swivel flange SNCS

For Ø	Type	Part no.
32	SNCS-32	174397
40	SNCS-40	174398
50	SNCS-50	174399
63	SNCS-63	174400
80	SNCS-80	174401

10 Swivel flange SNCL

For Ø	Type	Part no.
32	SNCL-32	174404
40	SNCL-40	174405
50	SNCL-50	174406
63	SNCL-63	174407
80	SNCL-80	174408

11 Swivel flange SNCB/SNCB-R3³⁾

For Ø	Type	Part no.	Type	Part no.
32	SNCB-32	174390	SNCB-32-R3	176944
40	SNCB-40	174391	SNCB-40-R3	176945
50	SNCB-50	174392	SNCB-50-R3	176946
63	SNCB-63	174393	SNCB-63-R3	176947
80	SNCB-80	174394	SNCB-80-R3	176948

3) SNCB-R3: high corrosion protection

12 Clevis foot LNG

For Ø	Type	Part no.
32	LNG-32	33890
40	LNG-40	33891
50	LNG-50	33892
63	LNG-63	33893
80	LNG-80	33894

14 Trunnion mounting kit DAMT

For Ø	Type	Part no.
32	DAMT-V1-32-A	2213233
40	DAMT-V1-40-A	2214899
50	DAMT-V1-50-A	2214909
63	DAMT-V1-63-A	2214971
80	DAMT-V1-80-A	163529

16 Right-angle clevis foot LQG

For Ø	Type	Part no.
32	LQG-32	31768
40	LQG-40	31769
50	LQG-50	31770
63	LQG-63	31771
80	LQG-80	31772

17 Rod clevis SGA

For Ø	Type	Part no.
32	SGA-M10x1,25	32954
40	SGA-M12x1,25	10767
50	SGA-M16x1,5	10768
63	SGA-M16x1,5	10768
80	SGA-M20x1,5	10769

27 Multi-position kit DPNC

For Ø	Type	Part no.
32	DPNC-32	174418
40	DPNC-40	174419
50	DPNC-50	174420
63	DPNC-63	174421
80	DPNC-80	174422

Piston rod cylinders > Tie rod and profile barrel cylinders >

Standards-based cylinders DSBF-C, to ISO 15552, clean design

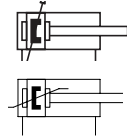

- Strokes of up to 2800 mm
 - Standards-based cylinder with increased corrosion protection
 - Resistant to conventional cleaning agents
 - Long service life thanks to optional dry-running seal
 - Comprehensive range of mounting accessories for just about every type of installation
 - Selected types in accordance with ATEX directive for potentially explosive atmospheres
- www.festo.com/ex

Order code

001 002 003 004 005 006 007 008 009 010 011 012 013 014 015
 DSBF - C - - - - - A - N3 - - - - - R

001	Type
DSBF	Double-acting standards-based cylinder
002	Design
C	Easy-to-clean design
003	Running characteristic
-	Standard
004	Piston Ø [mm]
...	32, 40, 50, 63, 80, 100, 125
005	Stroke [mm]
...	25, 40, 50, 80, 100, 125, 160, 200, 250, 320, 400, 500, 1 ... 2800
006	Piston rod type
-	At one end
007	Piston rod thread type
-	Male thread
008	Cushioning
PPV	Pneumatic cushioning adjustable at both ends
PPS	Pneumatic cushioning, self-adjusting at both ends

009	Position sensing
A	Via proximity switch
010	Standard
N3	Conforms to ISO 15552
011	Temperature range
-	Standard
012	Scraper variant
-	None
013	Extended piston rod
-	None
014	Extended piston rod thread
-	None
015	Sensor mounting, external
R	Mounting rail for sensors

Legend: Mandatory entry Optional entry

Product options

L	Running characteristic low friction	P	Elastic cushioning rings/ plates both ends	T1	Heat-resistant seals up to max. 120 °C	Scraper variant
U	Constant, slow movement	E...	Extended piston rod 1 ... 500 mm	T3	Low temperature -40 ... +80 °C	A1 Increased chemical resistance
T	Through piston rod	L...	Extended piston rod thread 0 ... 70 mm	T4	Heat-resistant seals 0 ... +150°C	A2 Hard scraper
F	Female piston rod thread			EX4	EU certification (II 2GD)	A3 Suitable for unlubricated operation

Configurable product

This product and all its product options can be ordered online via the configurator:

→ www.festo.com/catalogue/...

Enter the part number or the type.

Part no.	Type	Part no.	Type
570077	DSBF-C-...-32-...	570081	DSBF-C-...-80-...
570078	DSBF-C-...-40-...	570082	DSBF-C-...-100-...
570079	DSBF-C-...-50-...	1755169	DSBF-C-...-125-...
570080	DSBF-C-...-63-...		

Order

DSBF-C with pneumatic cushioning PPV adjustable at both ends

005 Stroke [mm]	004 Piston Ø [mm]						
	32	40	50	63	80	100	125
	008 Pneumatic cushioning, adjustable at both ends – 009 Via proximity sensor – 015 Mounting rail for sensors						
	PPV A-N3-R	PPV A-N3-R	PPV A-N3-R	PPV A-N3-R	PPV A-N3-R	PPV A-N3-R	PPV A-N3-R
25	1773752	1774259	1775258	1776043	1778429	1782253	1785012
40	1773753	1774260	1775259	1776044	1778430	1782254	1785013
50	1773754	1774261	1775260	1776045	1778431	1782255	1785014
80	1773755	1774262	1775261	1776046	1778432	1782256	1785015
100	1773756	1774263	1775262	1776047	1778433	1782257	1785016
125	1773757	1774264	1775263	1776048	1778434	1782258	1785017
160	1773758	1774265	1775264	1776049	1778435	1782259	1785018
200	1773759	1774266	1775265	1776050	1778436	1782260	1785019
250	1773760	1774267	1775266	1776051	1778437	1782261	1785020
320	1773761	1774268	1775267	1776052	1778438	1782262	1785021
400	1773762	1774269	1775268	1776053	1778439	1782263	1785022
500	1773763	1774270	1775269	1776054	1778440	1782264	1785023
1 ... 2800	1772262	1774182	1774418	1775324	1778184	1781598	1784637

DSBF-C with pneumatic cushioning PPS, self-adjusting at both ends

005 Stroke [mm]	004 Piston Ø [mm]						
	32	40	50	63	80	100	125
	008 Pneumatic cushioning, self-adjusting at both ends – 009 Via proximity sensor – 015 Mounting rail for sensors						
	PPS A-N3-R	PPS A-N3-R	PPS A-N3-R	PPS A-N3-R	PPS A-N3-R	PPS A-N3-R	PPS A-N3-R
25	1778834	1779431	1780283	1780905	1781061	1782823	1792953
40	1778835	1779432	1780284	1780906	1781062	1782824	1792954
50	1778836	1779433	1780285	1780907	1781063	1782825	1792955
80	1778837	1779434	1780286	1780908	1781064	1782826	1792956
100	1778838	1779435	1780287	1780909	1781065	1782827	1792957
125	1778839	1779436	1780288	1780910	1781066	1782828	1792958
160	1778840	1779437	1780289	1780911	1781067	1782829	1792959
200	1778841	1779438	1780290	1780912	1781068	1782830	1792960
250	1778842	1779439	1780291	1780913	1781069	1782831	1792961
320	1778843	1779440	1780292	1780914	1781070	1782832	1792962
400	1778844	1779441	1780293	1780915	1781071	1782833	1792963
500	1778845	1779442	1780294	1780916	1781072	1782834	1792964
1 ... 2800	1778516	1779309	1779742	1780600	1780945	1781567	1792703

Standards-based cylinder DSBF-C, ...-PPV with mounting kit SMB-8-C and proximity sensor CRSMT-8M



Standards-based cylinder DSBF-C, ...-PPS with self-aligning rod coupler CRFK



Piston rod cylinders > Tie rod and profile barrel cylinders >
Standards-based cylinders DSBF-C, to ISO 15552, Clean Design

Accessories

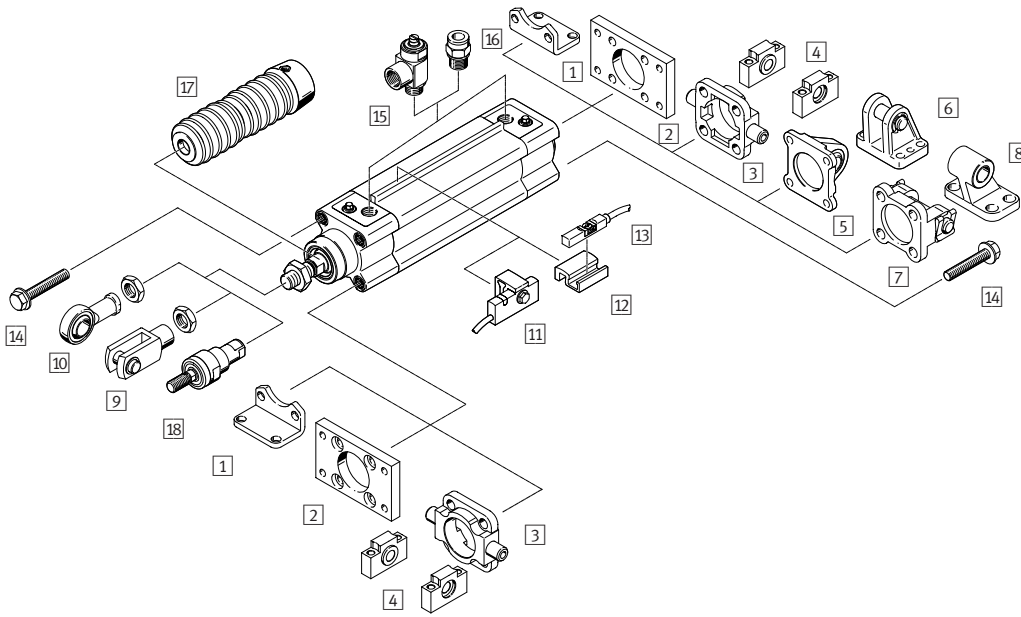

- 1 Foot mounting CRHNC → 38
- 2 Flange mounting CRFNG → 38
- 3 Trunnion flange CRZNG → 38
- 4 Trunnion support CRLNZG → 38
- 5 Swivel flange SNCS/CRSNCS/SNCS- ... -R3 → [dsbf](#)
- 6 Clevis foot LBG/LBG-R3 → [dsbf](#)
- 7 Swivel flange SNCB- ... -R3 → 38
- 8 Clevis foot CRLNG → 38
- 9 Rod clevis CRSG → 38
- 10 Rod eye CRSGS → 38
- 11 Proximity sensor SMT-C1 → [dsbf](#)
- 12 Mounting kit SMB-8-C → [dsbf](#)

- 13 Proximity sensor CRSMT-8M → [dsbf](#)
- 14 Plug screw DAMD → [dsbf](#)
- 15 One-way flow control valve CRGRLA → [dsbf](#)
- 16 Push-in fitting NPQH → 298, CRQS/CRQSL → [dsbf](#)
- 17 Bellows kit DADB → [dsbf](#)
- 18 Self-aligning rod coupler CRFK → 38

1 Foot mounting CRHNC		
For Ø	Type	Part no.
32	CRHNC-32	176937
40	CRHNC-40	176938
50	CRHNC-50	176939
63	CRHNC-63	176940
80	CRHNC-80	176941
100	CRHNC-100	176942
125	CRHNC-125	176943

3 Trunnion flange CRZNG		
For Ø	Type	Part no.
32	CRZNG-32	161852
40	CRZNG-40	161853
50	CRZNG-50	161854
63	CRZNG-63	161855
80	CRZNG-80	161856
100	CRZNG-100	161857
125	CRZNG-125	185362

7 Swivel flange SNCB		
For Ø	Type	Part no.
32	SNCB-32-R3	176944
40	SNCB-40-R3	176945
50	SNCB-50-R3	176946
63	SNCB-63-R3	176947
80	SNCB-80-R3	176948
100	SNCB-100-R3	176949
125	SNCB-125-R3	176950

9 Rod clevis CRSG		
For Ø	Type	Part no.
32	CRSG-M10x1,25	13569
40	CRSG-M12x1,25	13570
50, 63	CRSG-M16x1,5	13571
80, 100	CRSG-M20x1,5	13572
125	CRSG-M27x2	185361

2 Flange mounting CRFNG		
For Ø	Type	Part no.
32	CRFNG-32	161846
40	CRFNG-40	161847
50	CRFNG-50	161848
63	CRFNG-63	161849
80	CRFNG-80	161850
100	CRFNG-100	161851
125	CRFNG-125	185363

4 Trunnion support CRLNZG		
For Ø	Type	Part no.
32	CRLNZG-32	161874
40, 50	CRLNZG-40/50	161875
63, 80	CRLNZG-63/80	161876
100, 125	CRLNZG-100/125	161877

8 Clevis foot CRLNG		
For Ø	Type	Part no.
32	CRLNG-32	161840
40	CRLNG-40	161841
50	CRLNG-50	161842
63	CRLNG-63	161843
80	CRLNG-80	161844
100	CRLNG-100	161845
125	CRLNG-125	176951

10 Rod eye CRSGS		
For Ø	Type	Part no.
32	CRSGS-M10x1,25	195582
40	CRSGS-M12x1,25	195583
50, 63	CRSGS-M16x1,5	195584
80, 100	CRSGS-M20x1,5	195585
125	CRSGS-M27x2	195586

18 Self-aligning rod coupler CRFK		
For Ø	Type	Part no.
32	CRFK-M10x1,25	2305778
40	CRFK-M12x1,25	2305779
50, 63	CRFK-M16x1,5	2490673
80, 100	CRFK-M20x1,5	2545677

Compact cylinders ADN-S/AEN-S, double-acting/single-acting

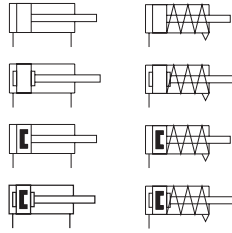

- Extremely small and lightweight
- Perfect for micro-movements
- Improved running characteristics thanks to precise manufacturing from a single piece
- Wide range of mounting options, interfaces from two sides

Order code

001 002 003 004 005 006 007
 - - - - - -

Legend: Mandatory entry Optional entry

001	Type
ADN	Double-acting compact cylinder
AEN	Single-acting compact cylinder
002	Design
S	Short
003	Piston Ø [mm]
...	6, 10, 12, 16, 20, 25, 32, 40, 50, 63
004	Stroke [mm]
...	5, 10, 15, 20, 25, 30, 35, 40, 45, 50

005	Piston rod thread
A	Male thread
I	Female thread
006	Cushioning
-	Without cushioning
P	Elastic cushioning rings/plates at both ends
007	Position sensing
-	Without position sensing
A	Via proximity switch

Order – AEN-S, single-acting, piston rod with male thread

004 Stroke [mm]	003 Piston Ø [mm]	6	10	12	16	20	25	32	40	50	63
	005 Piston rod with male thread – 006 Without cushioning – 007 Without position sensing										
	A --	A --									
5	8080593	8080583									
10	8080594	8080586									
	005 Piston rod with male thread – 006 Without cushioning – 007 For position sensing										
	A -- A	A -- A									
5	8080591	8080584									
10	8080592	8080585									
	005 Piston rod with male thread – 006 Elastic cushioning rings/plates at both ends – 007 Without position sensing										
		A - P - -	A - P - -	A - P - -	A - P - -	A - P - -	A - P - -	A - P - -			
5		8092150	8092144	8092220	8092182	8092167					
10		8092149	8092143	8092219	8092179	8092164					
25			8092140	8092224	8092180	8092163					
	005 Piston rod with male thread – 006 Elastic cushioning rings/plates at both ends – 007 For position sensing										
		A - P - A	A - P - A	A - P - A	A - P - A	A - P - A	A - P - A	A - P - A	A - P - A	A - P - A	A - P - A
5		8092152	8092142	8092222	8092177	8092165	8092162				
10		8092151	8092139	8092221	8092178	8092166	8092161	8092153	8092148		
25			8092141	8092223	8092181	8092168	8092160	8092154	8092146		

Cylinders with piston rod > Compact, short-stroke and flat cylinders >

Compact cylinders ADN-S/AEN-S, double-acting/single-acting

Ordering – AEN-S, single-acting, piston rod with female thread

004 Stroke [mm]	003 Piston Ø [mm]		6	10	12	16	20	25	32	40	50	63
	005 Piston rod with female thread – 006 Without cushioning – 007 Without position sensing											
	I – –	I – –										
5	4984929	4891759										
10	4984930	4891760										
	005 Piston rod with female thread – 006 Without cushioning – 007 For position sensing											
	I – – A	I – – A										
5	5267300	5269268										
10	5267301	5269269										
	005 Piston rod with female thread – 006 Elastic cushioning rings/plates at both ends – 007 Without position sensing											
			I – P – –	I – P – –	I – P – –	I – P – –	I – P – –	I – P – –				
5			8076479	8076496	8076501	8076509	8076512					
10			8076476	8076492	8076499	8076507	8076510					
25			8076497	8076503	8076504	8076514						
	005 Piston rod with female thread – 006 Elastic cushioning rings/plates at both ends – 007 For position sensing											
			I – P – A	I – P – A	I – P – A	I – P – A	I – P – A	I – P – A	I – P – A	I – P – A	I – P – A	I – P – A
5			8076475	8076495	8076502	8076506	8076511	5149290				
10			8076477	8076493	8076498	8076505	8076515	5149291	5137803	5132651		
25			8076494	8076500	8076508	8076513	5149292	5137804	5132652			

Ordering – ADN-S, double-acting, piston rod with male thread

004 Stroke [mm]	003 Piston Ø [mm]		6	10	12	16	20	25	32	40	50	63
	005 Piston rod with male thread – 006 Without cushioning – 007 Without position sensing											
	A – –	A – –										
5	8080598	8080589										
10	8080596	8080588										
	005 Piston rod with male thread – 006 Without cushioning – 007 For position sensing											
	A – – A	A – – A										
5	8080597	8080587										
10	8080595	8080590										
	005 Piston rod with male thread – 006 Elastic cushioning rings/plates at both ends – 007 Without position sensing											
			A – P – –	A – P – –	A – P – –	A – P – –	A – P – –	A – P – –				
5			8091419	8091671	8091431	8092103	8091452					
10			8091428	8091670	8091449	8092102	8091461					
15			8091416	8091677	8091447	8092107	8091460					
20			8091420	8091666	8091445	8092091	8091453					
25			8091426	8091665	8091443	8092092	8091467					
30			8091423	8091672	8091441	8092099	8091465					
35			8091418	8091676	8091439	8092097	8091456					
40					8091437	8092094	8091450					
45					8091435	8092106	8091451					
50					8091433	8092105	8091462					
	005 Piston rod with male thread – 006 Elastic cushioning rings/plates at both ends – 007 For position sensing											
			A – P – A	A – P – A	A – P – A	A – P – A	A – P – A	A – P – A	A – P – A	A – P – A	A – P – A	A – P – A
5			8091427	8091668	8091430	8092104	8091464	8092050	8092081	8092130		
10			8091424	8091678	8091448	8092093	8091457	8092067	8092073	8092128		
15			8091422	8091667	8091446	8092096	8091469	8092053	8092085	8092135		
20			8091429	8091674	8091444	8092109	8091468	8092064	8092076	8092120		
25			8091421	8091675	8091442	8092100	8091459	8092056	8092075	8092121		
30			8091417	8091669	8091440	8092098	8091454	8092061	8092074	8092125		
35			8091425	8091673	8091438	8092108	8091463	8092051	8092071	8092133		
40					8091436	8092095	8091455	8092059	8092087	8092134		
45					8091434	8092110	8091466	8092065	8092079	8092138		
50					8091432	8092101	8091458	8092054	8092086	8092119		

Ordering – ADN-S, double-acting, piston rod with female thread

004 Stroke [mm]	003 Piston Ø [mm]									
	6	10	12	16	20	25	32	40	50	63
	005 Piston rod with female thread – 006 Without cushioning – 007 Without position sensing									
	I – –	I – –								
5	4886885	4887523								
10	4886886	4887524								
	005 Piston rod with female thread – 006 Without cushioning – 007 For position sensing									
	I – – A	I – – A								
5	5173732	5177082								
10	5173733	5177085								
	005 Piston rod with female thread – 006 Elastic cushioning rings/plates at both ends – 007 Without position sensing									
			I – P – –	I – P – –	I – P – –	I – P – –	I – P – –			
5			8076407	8076393	8076323	8076343	8076364			
10			8076419	8076405	8076341	8076361	8076382			
15			8076417	8076403	8076339	8076359	8076380			
20			8076415	8076401	8076337	8076357	8076378			
25			8076413	8076399	8076335	8076355	8076376			
30			8076411	8076397	8076333	8076353	8076374			
35			8076409	8076395	8076331	8076351	8076372			
40					8076329	8076349	8076370			
45					8076327	8076347	8076368			
50					8076325	8076345	8076366			
	005 Piston rod with female thread – 006 Elastic cushioning rings/plates at both ends – 007 For position sensing									
			I – P – A	I – P – A	I – P – A	I – P – A	I – P – A	I – P – A	I – P – A	I – P – A
5			8076406	8076392	8076322	8076342	8076363	5138606	5138188	5132663
10			8076418	8076404	8076340	8076360	8076381	5138607	5138189	5132664
15			8076416	8076402	8076338	8076358	8076379	5138608	5138190	5132665
20			8076414	8076400	8076336	8076356	8076377	5138609	5138191	5132666
25			8076412	8076398	8076334	8076354	8076375	5138610	5138192	5132667
30			8076410	8076396	8076332	8076352	8076373	5138611	5138193	5132668
35			8076408	8076394	8076330	8076350	8076371	5138612	5138194	5132669
40					8076328	8076348	8076369	5138613	5138195	5132670
45					8076326	8076346	8076367	5138614	5138196	5132671
50					8076324	8076344	8076365	5138615	5138197	5132672

Cylinders with piston rod > Compact, short-stroke and flat cylinders >
Compact cylinders ADN-S/AEN-S, double-acting/single-acting

Accessories

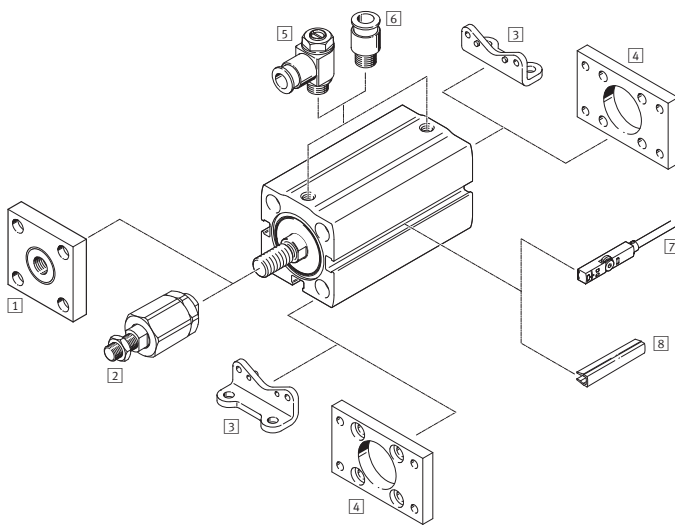

- 1 Coupling piece KSG → 42
- 2 Self-aligning rod coupler FK → 42
- 3 Foot mounting HNA → 42
- 4 Flange mounting FNC → 42
- 5 One-way flow control valve GRLA/ GRLZ → 192
- 6 Push-in fitting → [adn-s](#)
- 7 Proximity sensor
SMT-10M → 42
SMT-8M → 42
CRSMT-8M/SDBT-MS → [adn-s](#)
Position transmitter
SDAS-MHS/SDAT-MHS/SMAT-8M → [adn-s](#)
Connecting cables NEBU → 42
- 8 Slot cover ABP-5 → [adn-s](#)

Accessories for piston Ø 12 ... 63 mm

1 Coupling piece KSG		
For Ø	Type	Part no.
32, 40	KSG-M10x1,25	32963
50, 63	KSG-M12x1,25	32964

2 Self-aligning rod coupler FK		
For Ø	Type	Part no.
12	FK-M5	30984
16	FK-M6	2061
20, 25	FK-M8	2062
32, 40	FK-M10x1,25	6140
50, 63	FK-M12x1,25	6141

3 Foot mounting HNA		
For Ø	Type	Part no.
12	HNA-12	537237
16	HNA-16	537238
20	HNA-20	537239
25	HNA-25	537240
32	HNA-32	537241
40	HNA-40	537242
50	HNA-50	537243
63	HNA-63	537244

4 Flange mounting FNC		
For Ø	Type	Part no.
12	FNC-12	537245
16	FNC-16	537246
20	FNC-20	537247
25	FNC-25	537248
32	FNC-32	174376
40	FNC-40	174377
50	FNC-50	174378
63	FNC-63	174379

Proximity sensor for piston Ø 6, 10 mm

7 Proximity switch, N/O, magneto-resistive SMT-10M		
Description	Type	Part no.
PNP, for round slot, inserted in the slot from above		
Cable, 3-core, lengthwise, 2.5 m	SMT-10M-PS-24V-E-2,5-L-OE	551373
Plug M8x1, 3-pin, lengthwise, 0.3 m	SMT-10M-PS-24V-E-0,3-L-M8D	551375

7 Connecting cable NEBU			
Cable length	Connection right	Type	Part no.
Connection left: straight socket, M8x1, 3-pin			
2.5 m	Cable, open end, 3-wire	NEBU-M8G3-K-2.5-LE3	541333
5 m		NEBU-M8G3-K-5-LE3	541334
Connection left: angled socket, M8x1, 3-pin			
2.5 m	Cable, open end, 3-wire	NEBU-M8W3-K-2.5-LE3	541338
5 m		NEBU-M8W3-K-5-LE3	541341

Proximity sensor for piston Ø 12 ... 63 mm

7 Proximity switch, N/O, magneto-resistive SMT-8M		
Description	Type	Part no.
PNP, for T-slot, inserted in the slot from above, flush with the cylinder profile, short version		
Cable, 3-wire, 2.5 m	SMT-8M-A-PS-24V-E-2,5-OE	574335
Plug M8x1, 3-pin, 0.3 m	SMT-8M-A-PS-24V-E-0,3-M8D	574334
NPN, for T-slot, inserted in the slot from above, flush with the cylinder profile, short version		
Cable, 3-wire, 2.5 m	SMT-8M-A-NS-24V-E-2,5-OE	574338
Plug M8x1, 3-pin, 0.3 m	SMT-8M-A-NS-24V-E-0,3-M8D	574339

7 Proximity sensor, N/C, magneto-resistive SMT-8M		
Description	Type	Part no.
PNP, for T-slot, inserted in the slot from above, flush with the cylinder profile, short version		
Cable, 3-wire, 7.5 m	SMT-8M-A-PO-24V-E-7,5-OE	574340

7 Connecting cable NEBU			
Cable length	Connection right	Type	Part no.
Connection left: straight socket, M8x1, 3-pin			
2.5 m	Cable, open end, 3-wire	NEBU-M8G3-K-2.5-LE3	541333
5 m		NEBU-M8G3-K-5-LE3	541334
Connection left: angled socket, M8x1, 3-pin			
2.5 m	Cable, open end, 3-wire	NEBU-M8W3-K-2.5-LE3	541338
5 m		NEBU-M8W3-K-5-LE3	541341

Cylinders with piston rod > Compact, short-stroke and flat cylinders >
Compact cylinders ADN, to ISO 21287, double-acting

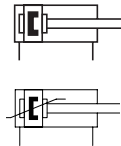

- Compact cylinders with standard dimensions
- Up to 50% less installation space than comparable standards-based cylinders to ISO 15552
- Innovative technology for maximum speeds
- Flexible in use thanks to easy-to-configure variants
- Selected types in accordance with ATEX directive for potentially explosive atmospheres
→ www.festo.com/ex

Order code – Basic design

001 002 003 004 005 006 007 008 009 010 011 012 013 014 015 016
ADN - - - - - **A** - - - - - - - - - - -

001	Type	009	Temperature resistance
ADN	Double-acting compact cylinder, to ISO 21287	-	Standard
002	Piston Ø [mm]	010	Constant motion
...	12, 16, 20, 25, 32, 40, 50, 63, 80	-	None
003	Stroke [mm]	011	Low friction
...	5, 10, 15, 20, 25, 30, 40, 50, 60, 80	-	Standard
004	Piston rod thread type	012	Increased lateral force
A	Male thread	-	None
I	Female thread	013	Captive rating plate
005	Cushioning	-	Rating plate, glued
P	Elastic cushioning rings/plates at both ends	014	Low temperature
PPS	Pneumatic cushioning, self-adjusting at both ends	-	None
006	Position sensing	015	Wiper seal
A	Via proximity switch	-	Standard
007	Protection against rotation	016	EU certification (ATEX)
-	None	-	None
008	Piston rod type		
-	Piston rod at one end		

Legend: Mandatory entry Optional entry

Product options

100, 125 mm Piston Ø	S2	Through piston rod	K5	Special piston rod thread	S11	Low friction
1 ... 500 mm Variable stroke	S20	Through, hollow piston rod	K10	Smooth anodised aluminium piston rod	R3	High corrosion protection
Q Square piston rod	K2	Extended male piston rod thread	S6	Heat-resistant seals up to max. 120 °C	R8	Dust protection
K8 Extended piston rod			S10	Slow speed	TL	Laser etched rating plate
S1 Reinforced piston rod					TT	Low temperature
					KP	With clamping unit, attached
					EL...	With end-position locking

Configurable product

This product and all its product options can be ordered online via the configurator:
 → www.festo.com/catalogue/...
 Enter the part number or the type.

Part no.	Type	Part no.	Type	Part no.	Type
536203	ADN-12-...-A	536267	ADN-32-...-A	536351	ADN-80-...-A
536218	ADN-16-...-A	536288	ADN-40-...-A	536372	ADN-100-...-A
536233	ADN-20-...-A	536309	ADN-50-...-A	536393	ADN-125-...-A
536250	ADN-25-...-A	536330	ADN-63-...-A		

Cylinders with piston rod > Compact, short-stroke and flat cylinders >

Compact cylinders ADN, to ISO 21287, double-acting

Ordering – Basic design

003 Stroke [mm]	002 Piston Ø [mm]								
	12	16	20	25	32	40	50	63	80
004 Piston rod with male thread – 005 Elastic cushioning rings/plates at both ends – 006 Position sensing									
	A – P – A	A – P – A	A – P – A	A – P – A	A – P – A	A – P – A	A – P – A	A – P – A	A – P – A
5	536204	536219	536234	536251	536268	536289	536310		
10	536205	536220	536235	536252	536269	536290	536311	536332	536353
15	536206	536221	536236	536253	536270	536291	536312	536333	536354
20	536207	536222	536237	536254	536271	536292	536313	536334	536355
25	536208	536223	536238	536255	536272	536293	536314	536335	536356
30	536209	536224	536239	536256	536273	536294	536315	536336	536357
40	536210	536225	536240	536257	536274	536295	536316	536337	536358
50		536331	536241	536258	536275	536296	536317	536338	536359
60			536352	536373	536276	536297	536318	536339	536360
80					536277	536298	536319	536340	536361
004 Piston rod with male thread – 005 Pneumatic cushioning, self-adjusting at both ends – 006 Position sensing									
					A – PPS – A	A – PPS – A	A – PPS – A	A – PPS – A	A – PPS – A
10					572655	572673	572691	572709	572727
15					572656	572674	572692	572710	572728
20					572657	572675	572693	572711	572729
25					572658	572676	572694	572712	572730
30					572659	572677	572695	572713	572731
40					572660	572678	572696	572714	572732
50					572661	572679	572697	572715	572733
60					572662	572680	572698	572716	572734
80					572663	572681	572699	572717	572735
004 Piston rod with female thread – 005 Elastic cushioning rings/plates at both ends – 006 Position sensing									
	I – P – A	I – P – A	I – P – A	I – P – A	I – P – A	I – P – A	I – P – A	I – P – A	I – P – A
5	536211	536226	536242	536259	536278	536299	536320		
10	536212	536227	536243	536260	536279	536300	536321	536342	536363
15	536213	536228	536244	536261	536280	536301	536322	536343	536364
20	536214	536229	536245	536262	536281	536302	536323	536344	536365
25	536215	536230	536246	536263	536282	536303	536324	536345	536366
30	536216	536231	536247	536264	536283	536304	536325	536346	536367
40	536217	536232	536248	536265	536284	536305	536326	536347	536368
50		536341	536249	536266	536285	536306	536327	536348	536369
60			536362	536383	536286	536307	536328	536349	536370
80					536287	536308	536329	536350	536371
004 Piston rod with female thread – 005 Pneumatic cushioning, self-adjusting at both ends – 006 Position sensing									
					I – PPS – A	I – PPS – A	I – PPS – A	I – PPS – A	I – PPS – A
10					572646	572664	572682	572700	572718
15					572647	572665	572683	572701	572719
20					572648	572666	572684	572702	572720
25					572649	572667	572685	572703	572721
30					572650	572668	572686	572704	572722
40					572651	572669	572687	572705	572723
50					572652	572670	572688	572706	572724
60					572653	572671	572689	572707	572725
80					572654	572672	572690	572708	572726

P and PPS cushioning



P cushioning:
Elastic cushioning rings/plates at both ends



PPS cushioning:
Pneumatic cushioning, self-adjusting at both ends

Accessories

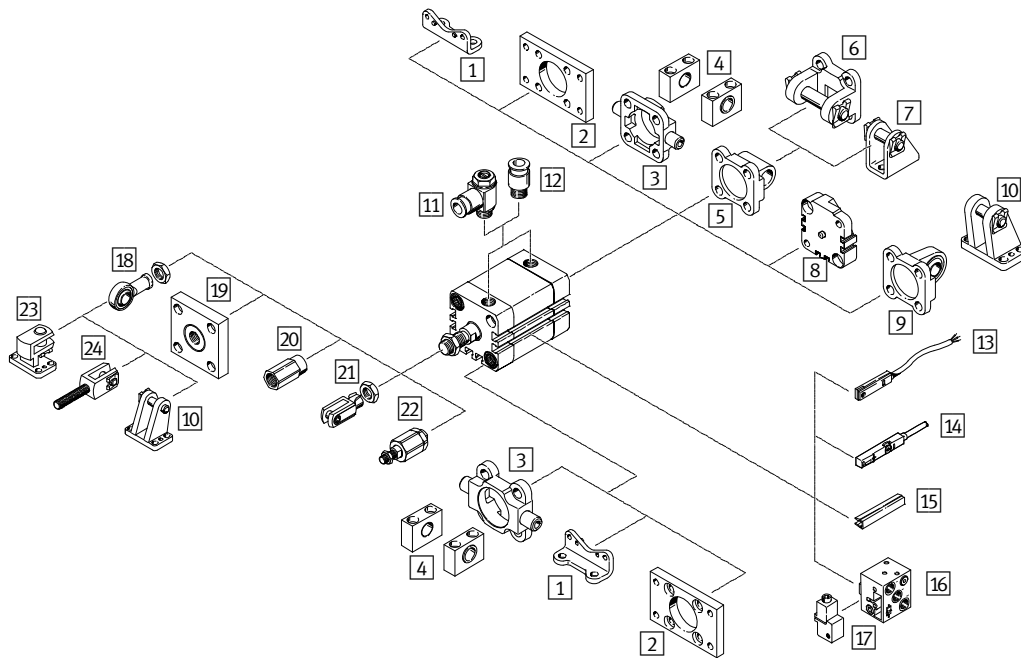

- 1 Foot mounting HNA → 45
- 2 Flange mounting FNC → 45
- 3 Trunnion flange ZNCF → 35
- 4 Trunnion support LNZG → 35
- 5 Swivel flange SNCL → 45
- 6 Swivel flange SNCB → 35
- 7 Clevis foot LBN → 28
- 8 Multi-position kit DPNA → 45
- 9 Swivel flange SNCS → 35
- 10 Clevis foot LBG → [adn](#)
- 11 One-way flow control valve GRLA/GLRZ → 192
- 12 Push-in fitting QS → 293
- 13 Proximity sensor SME-8 → [adn](#)
Connecting cable NEBU → 45

- 14 Proximity sensor SMT-8M → 223
Connecting cable NEBU → 45
- 15 Slot cover ABP-5-S → [adn](#)

- 16 Proximity switch SMPO-8E → [adn](#)
- 17 Mounting kit SMB-8E → [adn](#)
- 18 Rod eye SGS → 66
- 19 Coupling piece KSG/KSZ → [adn](#)
- 20 Adapter AD → [adn](#)

- 21 Rod clevis SG → 66
- 22 Self-aligning rod coupler FK → 66
- 23 Right-angle clevis foot LQG → 45
- 24 Rod clevis SGA → 45

1 Foot mounting HNA		
For Ø	Type	Part no.
12	HNA-12	537237
16	HNA-16	537238
20	HNA-20	537239
25	HNA-25	537240
32	HNA-32	537241
40	HNA-40	537242
50	HNA-50	537243
63	HNA-63	537244
80	HNA-80	537249

5 Swivel flange SNCL		
For Ø	Type	Part no.
12	SNCL-12	537790
16	SNCL-16	537791
20	SNCL-20	537792
25	SNCL-25	537793
32	SNCL-32	174404
40	SNCL-40	174405
50	SNCL-50	174406
63	SNCL-63	174407
80	SNCL-80	174408

23 Right-angle clevis foot LQG		
For Ø	Type	Part no.
32, 40	LQG-32	31768
50, 63	LQG-40	31769
80	LQG-50	31770

24 Rod clevis SGA		
For Ø	Type	Part no.
32, 40	SGA-M10x1,25	32954
50, 63	SGA-M12x1,25	10767
80	SGA-M16x1,25	10768

2 Flange mounting FNC		
For Ø	Type	Part no.
12	FNC-12	537245
16	FNC-16	537246
20	FNC-20	537247
25	FNC-25	537248
32	FNC-32	174376
40	FNC-40	174377
50	FNC-50	174378
63	FNC-63	174379
80	FNC-80	174380

8 Multi-position kit DPNA		
For Ø	Type	Part no.
12	DPNA-12	537263
16	DPNA-16	537264
20	DPNA-20	537265
25	DPNA-25	537266
32	DPNA-32	537267
40	DPNA-40	537268
50	DPNA-50	537269
63	DPNA-63	537270
80	DPNA-80	537271

13/14 Connecting cable NEBU			
Cable length	Connection right	Type	Part no.
Connection left: straight socket, M8x1, 3-pin			
2.5 m	Cable, open end, 3-wire	NEBU-M8G3-K-2.5-LE3	541333
5 m			541334
Connection left: angled socket, M8x1, 3-pin			
2.5 m	Cable, open end, 3-wire	NEBU-M8W3-K-2.5-LE3	541338
5 m			541341
Connection left: straight socket, M12x1, 5-pin			
2.5 m	Cable, open end, 3-wire	NEBU-M12G5-K-2.5-LE3	541363
5 m			541364
Connection left: angled socket, M12x1, 5-pin			
2.5 m	Cable, open end, 3-wire	NEBU-M12W5-K-2.5-LE3	541367
5 m			541370

Cylinders with piston rod > Compact, short-stroke and flat cylinders >

Short-stroke cylinders ADVC/AEVC, double-acting/single-acting

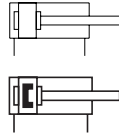

- High clamping forces in a compact size
- With mounting hole pattern to ISO 15552 as of piston Ø 32 mm
- Application-oriented housing and piston rod variants
- Supply ports and profile slot for proximity sensors on one side

Order code – Basic design

001 002 003 004 005 006
 - - - - P -

Legend: Mandatory entry Optional entry

001	Type
ADVC	Double-acting short-stroke cylinder
AEVC	Single-acting short-stroke cylinder
002	Piston Ø [mm]
...	12, 16, 20, 25, 32, 40, 50, 63
003	Stroke [mm]
...	5, 10, 15, 20, 25

004	Piston rod thread
A	Male thread
I	Female thread
005	Cushioning
P	Elastic cushioning rings/plates at both ends
006	Position sensing
-	Without position sensing
A	Via proximity switch

Product options

- 4 ... 100 mm Piston Ø
- Without piston rod thread

Configurable product

This product and all its product options can be ordered online via the configurator:

→ www.festo.com/catalogue/advc

Ordering – Basic design AEVC, single-acting

003 Stroke [mm]	002 Piston Ø [mm]							
	12	16	20	25	32	40	50	63
	004 Piston rod with male thread – 005 Cushioning – 006 Without position sensing							
	A – P	A – P	A – P	A – P	A – P	A – P	A – P	A – P
5	188086	188105	188137	188169	188201			
10	188087	188106	188138	188170	188202	188230	188258	188282
25		188107	188139	188171	188203	188231	188259	188283
	004 Piston rod with female thread – 005 Cushioning – 006 Without position sensing							
	I – P	I – P	I – P	I – P	I – P	I – P	I – P	I – P
5	188082	188099	188131	188163	188195			
10	188083	188100	188132	188164	188196	188226	188254	188278
25		188101	188133	188165	188197	188227	188255	188279

Ordering – Basic design ADVC, double-acting

003 Stroke [mm]	002 Piston Ø [mm]							
	12	16	20	25	32	40	50	63
	004 Piston rod with male thread – 005 Cushioning – 006 Without position sensing							
	A – P	A – P	A – P	A – P	A – P	A – P	A – P	A – P
5	188094	188123	188155	188187	188219	188247		
10	188095	188124	188156	188188	188220	188248	188272	188296
15		188125	188157	188189	188221	188249	188273	188297
20		188126	188158	188190	188222	188250	188274	188298
25		188127	188159	188191	188223	188251	188275	188299
	004 Piston rod with female thread – 005 Cushioning – 006 Without position sensing							
	I – P	I – P	I – P	I – P	I – P	I – P	I – P	I – P
5	188090	188113	188145	188177	188209	188237		
10	188091	188114	188146	188178	188210	188238	188264	188288
15		188115	188147	188179	188211	188239	188265	188289
20		188116	188148	188180	188212	188240	188266	188290
25		188117	188149	188181	188213	188241	188267	188291
	004 Piston rod with male thread – 005 Cushioning – 006 Position sensing via proximity sensor							
	A – P – A	A – P – A	A – P – A	A – P – A	A – P – A	A – P – A	A – P – A	A – P – A
5	188092	188118	188150	188182	188214	188242		
10	188093	188119	188151	188183	188215	188243	188268	188292
15		188120	188152	188184	188216	188244	188269	188293
20		188121	188153	188185	188217	188245	188270	188294
25		188122	188154	188186	188218	188246	188271	188295
	004 Piston rod with female thread – 005 Cushioning – 006 Position sensing via proximity sensor							
	I – P – A	I – P – A	I – P – A	I – P – A	I – P – A	I – P – A	I – P – A	I – P – A
5	188088	188108	188140	188172	188204	188232		
10	188089	188109	188141	188173	188205	188233	188260	188284
15		188110	188142	188174	188206	188234	188261	188285
20		188111	188143	188175	188207	188235	188262	188286
25		188112	188144	188176	188208	188236	188263	188287

Cylinders with piston rod > Compact, short-stroke and flat cylinders >

Short-stroke cylinders ADVC/AEVC, double-acting/single-acting

Accessories

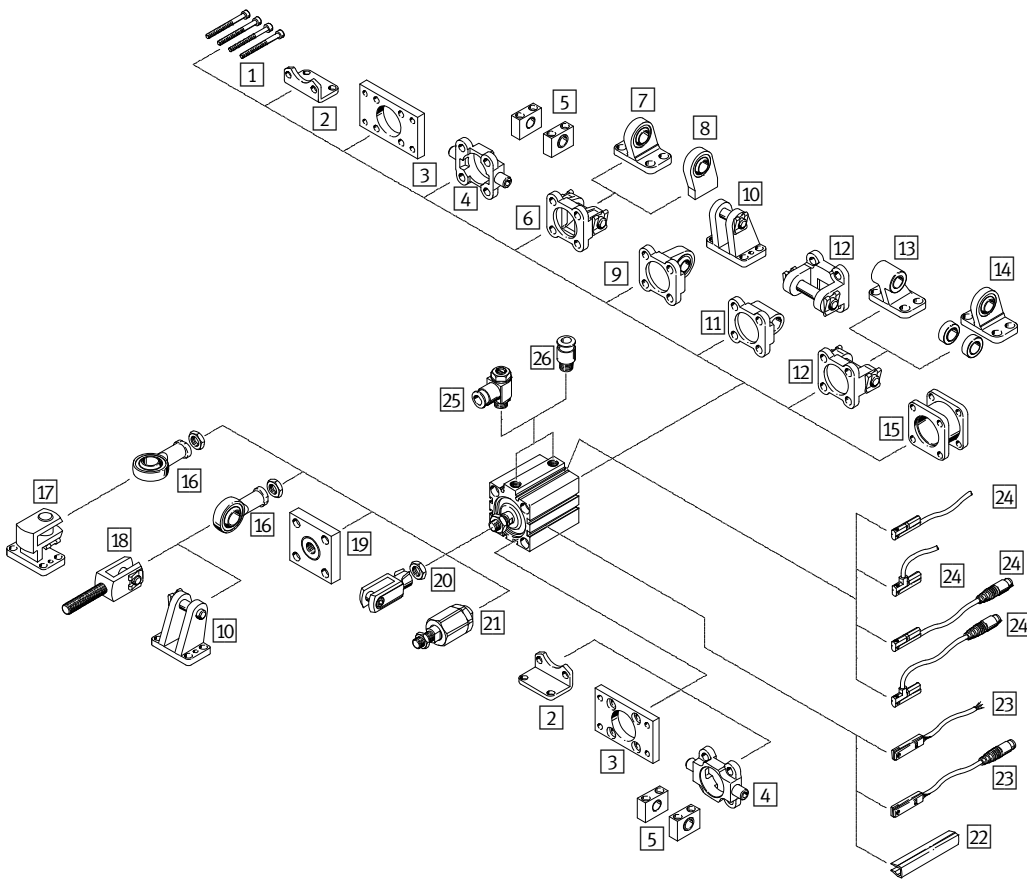

- 1 Mounting screws (not included in the scope of delivery)
- 2 Foot mounting HNC → 35
- 3 Flange mounting FNC → 35
- 4 Trunnion flange ZNCF → 35
- 5 Trunnion support LNZG → 35
- 6 Swivel flange SNC → 35
- 7 Clevis foot LSNG → [advc](#)
- 8 Clevis foot LSNSG → [advc](#)
- 9 Swivel flange SNCS → 35
- 10 Clevis foot LBG → [advc](#)
- 11 Swivel flange SNCL → 35
- 12 Swivel flange SNCB → 35
- 13 Clevis foot LNG → 48
- 14 Clevis foot LSN → [advc](#)
- 15 Multi-position kit DPNC → 35
- 16 Rod eye SGS → 48
- 17 Right-angle clevis foot LQG → 48
- 18 Rod clevis SGA → 48
- 19 Coupling piece KSG → [advc](#)
- 20 Rod clevis SG → 48
- 21 Self-aligning rod coupler FK → 48
- 22 Slot cover ABP-5-S → [advc](#)

- 23 Proximity sensor SMT-8M/SME-8M → 48
Connecting cable NEBU → 48

- 24 Proximity sensor SMT-10M → 48
Connecting cable NEBU → 48

- 25 One-way flow control valve GRLA → 192
- 26 Push-in fitting QS → 293

13 Clevis foot LNG		
For Ø	Type	Part no.
32	LNG-32	33890
40	LNG-40	33891
50	LNG-50	33892
63	LNG-63	33893

18 Rod clevis SGA		
For Ø	Type	Part no.
32, 40	SGA-M10x1,25	32954
50, 63	SGA-M12x1,25	10767

23 Proximity sensor, N/O, magneto-resistive SMT-8M		
Description	Type	Part no.
PNP, for T-slot, inserted in the slot from above, flush with the cylinder profile, short version		
Cable, 3-wire, 2.5 m	SMT-8M-A-PS-24V-E-2,5-OE	574335
Plug M8x1, 3-pin, 0.3 m	SMT-8M-A-PS-24V-E-0,3-M8D	574334
Plug M12x1, 3-pin, 0.3 m	SMT-8M-A-PS-24V-E-0,3-M12	574337
NPN, for T-slot, inserted in the slot from above, flush with the cylinder profile, short version		
Cable, 3-wire, 2.5 m	SMT-8M-A-NS-24V-E-2,5-OE	574338
Plug M8x1, 3-pin, 0.3 m	SMT-8M-A-NS-24V-E-0,3-M8D	574339

16 Rod eye SGS		
For Ø	Type	Part no.
16	SGS-M6	9254
20, 25	SGS-M8	9255
32, 40	SGS-M10x1,25	9261
50, 63	SGS-M12x1,25	9262

20 Rod clevis SG		
For Ø	Type	Part no.
16	SG-M6	3110
20, 25	SG-M8	3111
32, 40	SG-M10x1,25	6144
50, 63	SG-M12x1,25	6145

23 Proximity sensor, N/O, magnetic reed SME-8M		
Description	Type	Part no.
Contacting, for T-slot, inserted in the slot from above, flush with the cylinder profile		
Cable, 2.5 m, 3-wire	SME-8M-DS-24V-K-2,5-OE	543862
Cable, 5 m, 3-wire	SME-8M-DS-24V-K-5,0-OE	543863
Cable, 2.5 m, 2-wire	SME-8M-ZS-24V-K-2,5-OE	543872
Plug M8x1, 3-pin	SME-8M-DS-24V-K-0,3-M8D	543861

17 Right-angle clevis foot LQG		
For Ø	Type	Part no.
32, 40	LQG-32	31768
50, 63	LQG-40	31769

21 Self-aligning rod coupler FK		
For Ø	Type	Part no.
12	FK-M5	30984
16	FK-M6	2061
20, 25	FK-M8	2062
32, 40	FK-M10x1,25	6140
50, 63	FK-M12x1,25	6141

23/24 Connecting cable NEBU			
Cable length	Connection right	Type	Part no.
Connection left: straight socket, M8x1, 3-pin			
2.5 m	Cable, open end, 3-wire	NEBU-M8G3-K-2.5-LE3	541333
5 m		NEBU-M8G3-K-5-LE3	541334
Connection left: angled socket, M8x1, 3-pin			
2.5 m	Cable, open end, 3-wire	NEBU-M8W3-K-2.5-LE3	541338
5 m		NEBU-M8W3-K-5-LE3	541341

24 Proximity sensor, N/O, magneto-resistive SMT-10M		
Description	Type	Part no.
PNP, for C-slot, inserted in the slot from above, flush with the cylinder profile		
Plug M8x1, 3-pin, lengthwise, 0.3 m	SMT-10M-PS-24V-E-0,3-L-M8D	551375
Cable, 3-core, lengthwise, 2.5 m	SMT-10M-PS-24V-E-2,5-L-OE	551373

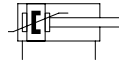

- With self-adjusting pneumatic end-position cushioning PPS
- Easy-to-clean design
- High corrosion protection

- Selected types in accordance with ATEX directive for potentially explosive atmospheres

→ www.festo.com/ex

Order code – Basic design

001 002 003 004 005 006 007 008
 CRDSNU - B - 25 - - PPS - A - MG - A1

Legend: Mandatory entry

001	Type
CRDSNU	Double-acting standards-based cylinder, stainless steel
002	Design
B	Products in stock
003	Piston Ø [mm]
25	25
004	Stroke [mm]
...	10, 25, 40, 50, 80, 100, 125, 160, 200
005	Cushioning
PPS	Pneumatic cushioning, self-adjusting at both ends

006	Position sensing
A	Via proximity switch
007	Cylinder end cap
MG	Bearing cap without mounting thread
008	Wiper ring variant
A1	Increased chemical resistance

Product options

12 ... 25 mm Piston Ø	MQ	Alternative plain cylinder end cap, lateral connection	K3	Female piston rod thread	TT	Low temperature –40 ... +80°C
1 ... 500 mm Variable stroke	A2	Hard scraper	K5	Custom piston rod thread		
P Elastic cushioning rings/ plates both ends	A3	For unlubricated operation	K8	Extended piston rod		
PPV Pneumatic cushioning adjustable at both ends	S2	Through piston rod				
	S6	Heat-resistant seals up to max. 120 °C				

Configurable product

This product and all its product options can be ordered online via the configurator:

→ www.festo.com/catalogue/...

Enter the part number or the type.

Part no.	Type
552787	CRDSNU-12-...
552788	CRDSNU-16-...
552789	CRDSNU-20-...
552790	CRDSNU-25-...

Cylinders with piston rod > Stainless-steel cylinders >
Standards-based cylinders CRDSNU, to ISO 6432, stainless steel

Ordering – Basic design

Round cylinders to ISO 6432		
003 Piston Ø [mm]	25	
004 Stroke [mm]	Type	Part no.
10	CRDSNU-B-25-10-PPS-A-MG-A1	2159636
25	CRDSNU-B-25-25-PPS-A-MG-A1	2159637
40	CRDSNU-B-25-40-PPS-A-MG-A1	2159638
50	CRDSNU-B-25-50-PPS-A-MG-A1	2159639
80	CRDSNU-B-25-80-PPS-A-MG-A1	2159640
100	CRDSNU-B-25-100-PPS-A-MG-A1	2159641
125	CRDSNU-B-25-125-PPS-A-MG-A1	2159642
160	CRDSNU-B-25-160-PPS-A-MG-A1	2159643
200	CRDSNU-B-25-200-PPS-A-MG-A1	2159644

Accessories

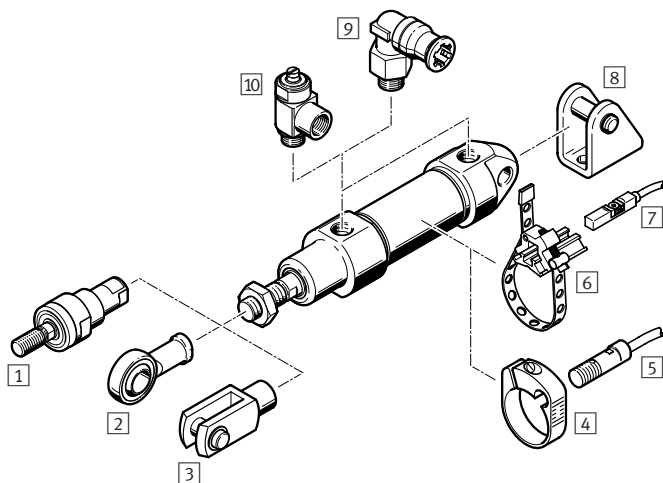

- 1 Self-aligning rod coupler CRFK
→ [crdsnu](#)
- 2 Rod eye CRSGS → [crdsnu](#)
- 3 Rod clevis CRSG → [crdsnu](#)
- 4 Mounting kit CRSMBR → 50
- 5 Proximity switch CRSMEO-4
→ 50
- 6 Mounting kit SMBR → [crdsnu](#)
- 7 Proximity switch CRSMT-8M
→ [crdsnu](#)
- 8 Clevis foot CRLBN → [crdsnu](#)
- 9 Push-in fitting CRQS → [crqs](#)
- 10 One-way flow control valve CRGRLA
→ [crdsnu](#)

4 Mounting kit CRSMBR, corrosion-resistant		
For Ø	Type	Part no.
12	CRSMBR-12	164581
16	CRSMBR-16	164582
20	CRSMBR-20	164583
25	CRSMBR-25	164584

5 Proximity switch CRSMEO-4, corrosion-resistant	
Type	Part no.
Cable length 2.5 m, N/O, 3-wire	
CRSMEO-4-K-LED-24	161775



- With self-adjusting pneumatic end-position cushioning PPS
- Easy-to-clean design
- High corrosion protection

- Selected types in accordance with ATEX directive for potentially explosive atmospheres
→ www.festo.com/ex

Order code – Basic design

001 002 003 004 005 006 007 008
CRDSNU - B - 32 - [] - PPS - A - MG - A1

Legend: Mandatory entry

001	Type
CRDSNU	Double-acting round cylinder, stainless steel
002	Design
B	Stock items
003	Piston Ø [mm]
32	32
004	Stroke [mm]
...	10, 25, 40, 50, 80, 100, 125, 160, 200
005	Cushioning
PPS	Pneumatic cushioning, self-adjusting at both ends

006	Position sensing
A	Via proximity switch
007	Cylinder end cap
MG	Bearing cap without mounting thread
008	Wiper ring variant
A1	Increased chemical resistance

Product options

32 ... 63 mm Piston Ø	MQ	Alternative plain cylinder end cap, lateral connection	K2	Extended male piston rod thread	TT	Low temperature –40 ... +80°C
1 ... 500 mm Variable stroke	A2	Hard scraper	K3	Female piston rod thread		
P Elastic cushioning rings/ plates both ends	A3	For unlubricated operation	K5	Custom piston rod thread		
PPV Pneumatic cushioning adjustable at both ends	S2	Through piston rod	K8	Extended piston rod		
	S6	Heat-resistant seals up to max. 120 °C				

Configurable product

This product and all its product options can be ordered online via the configurator:

→ www.festo.com/catalogue/...

Enter the part number or the type.

Part no.	Type
552791	CRDSNU-32-...
552792	CRDSNU-40-...
552793	CRDSNU-50-...
552794	CRDSNU-63-...

Cylinders with piston rod > Stainless-steel cylinders >
Round cylinders CRDSNU, stainless steel

Ordering – Basic design

Round cylinders		
003 Piston Ø [mm]	32	
004 Stroke [mm]	Type	Part no.
10	CRDSNU-B-32-10-PPS-A-MG-A1	2176399
25	CRDSNU-B-32-25-PPS-A-MG-A1	2176400
40	CRDSNU-B-32-40-PPS-A-MG-A1	2176401
50	CRDSNU-B-32-50-PPS-A-MG-A1	2176402
80	CRDSNU-B-32-80-PPS-A-MG-A1	2176403
100	CRDSNU-B-32-100-PPS-A-MG-A1	2176404
125	CRDSNU-B-32-125-PPS-A-MG-A1	2176405
160	CRDSNU-B-32-160-PPS-A-MG-A1	2176406
200	CRDSNU-B-32-200-PPS-A-MG-A1	2176407

Accessories

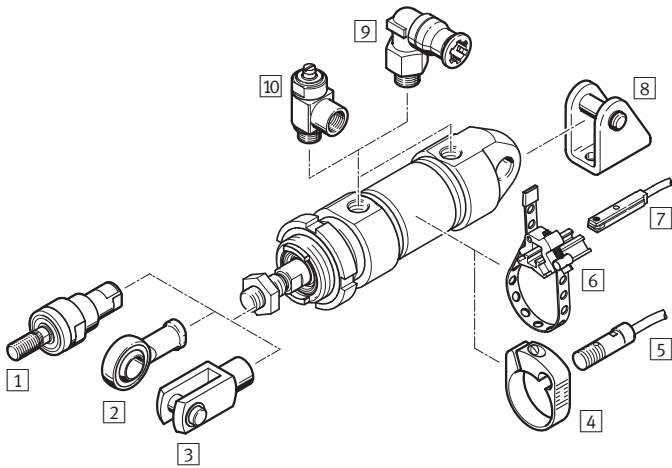

- 1 Self-aligning rod coupler CRFK
→ [crdsnu](#)
- 2 Rod eye CRSGS → [crdsnu](#)
- 3 Rod clevis CRSG → [crdsnu](#)
- 4 Mounting kit CRSMBR → 52
- 5 Proximity switch CRSMEO-4
→ 52
- 6 Mounting kit SMBR → [crdsnu](#)
- 7 Proximity switch CRSMT-8M
→ [crdsnu](#)
- 8 Clevis foot CRLBN → [crdsnu](#)
- 9 Push-in fitting CRQS → [crqs](#)
- 10 One-way flow control valve CRGRLA
→ [crdsnu](#)

4 Mounting kit CRSMBR, corrosion-resistant		
For Ø	Type	Part no.
32	CRSMBR-32	163888
40	CRSMBR-40	163889
50	CRSMBR-50	163890
63	CRSMBR-63	163891

5 Proximity sensor CRSMEO, corrosion-resistant	
Type	Part no.
Cable length 2.5 m, N/O, 3-wire	
CRSMEO-4-K-LED-24	161775

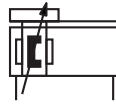

- Compact design: 30% smaller than the basic design DGC-G
 - Low moving dead weight
 - Without external guide, for simple drive functions
 - Symmetrical design
 - Easy assembly and installation
- Selected types in accordance with ATEX directive for potentially explosive atmospheres
→ www.festo.com/ex

Order code

001	002	003	004	005	006	007	008	009	010	011	012	
DGC	K			PPV	A						ZUB	

001	Type
DGC	Double-acting linear actuator
002	Guide
K	Compact
003	Piston Ø [mm]
...	18, 25, 32, 40, 50, 63, 80
004	Stroke [mm]
...	1 ... 8500
005	Cushioning
PPV	Pneumatic cushioning, adjustable at both ends
006	Position sensing
A	Via proximity switch
007	Basic design
GK	Standard piston
GV	Extended piston
008	Compressed air connection
-	At one end
D2	At both ends
009	Lubrication
-	Standard
H1	Lubrication approved for use in food applications

010	Moment compensator
-	None
FK	Moment compensator
011	EU certification
-	None
EX2	II 3GD in accordance with EU Directive 2014/34/EU
EX3	II 2G in accordance with EU Directive 2014/34/EU
012	Accessories
ZUB -	Accessories enclosed separately
F	Foot mounting (1 piece)
...M	Profile mounting (1 ... 10 pieces)
...Y	Slot nut (1 ... 10 pieces)
...B	Slot cover (1 ... 10 pieces)
...G	Proximity switch, N/O with cable, 2.5 m (1 ... 10 pieces)
...H	Proximity switch, N/O with plug (1 ... 10 pieces)
...I	Proximity switch, N/O, contactless with cable, 2.5 m (1 ... 10 pieces)
...J	Proximity switch, N/O, contactless with plug (1 ... 10 pieces)
...N	Proximity switch, N/C with cable, 7.5 m (1 ... 10 pieces)
...V	Connecting cable with plug, 2.5 m (1 ... 10 pieces)
...S	Slot cover for sensor slot (1 ... 10 pieces)

Legend: Mandatory entry Optional entry

Configurable product

This product and all its product options can be ordered online via the configurator:

→ www.festo.com/catalogue/...

Enter the part number or the type.

Part no.	Type	Part no.	Type
1312500	DGC-K-18-...-PPV-A-...	1312504	DGC-K-50-...-PPV-A-...
1312501	DGC-K-25-...-PPV-A-...	1312505	DGC-K-63-...-PPV-A-...
1312502	DGC-K-32-...-PPV-A-...	1312506	DGC-K-80-...-PPV-A-...
1312503	DGC-K-40-...-PPV-A-...		

Rodless cylinders > Mechanically coupled cylinders >
Linear drives DGC-K, double-acting

Accessories

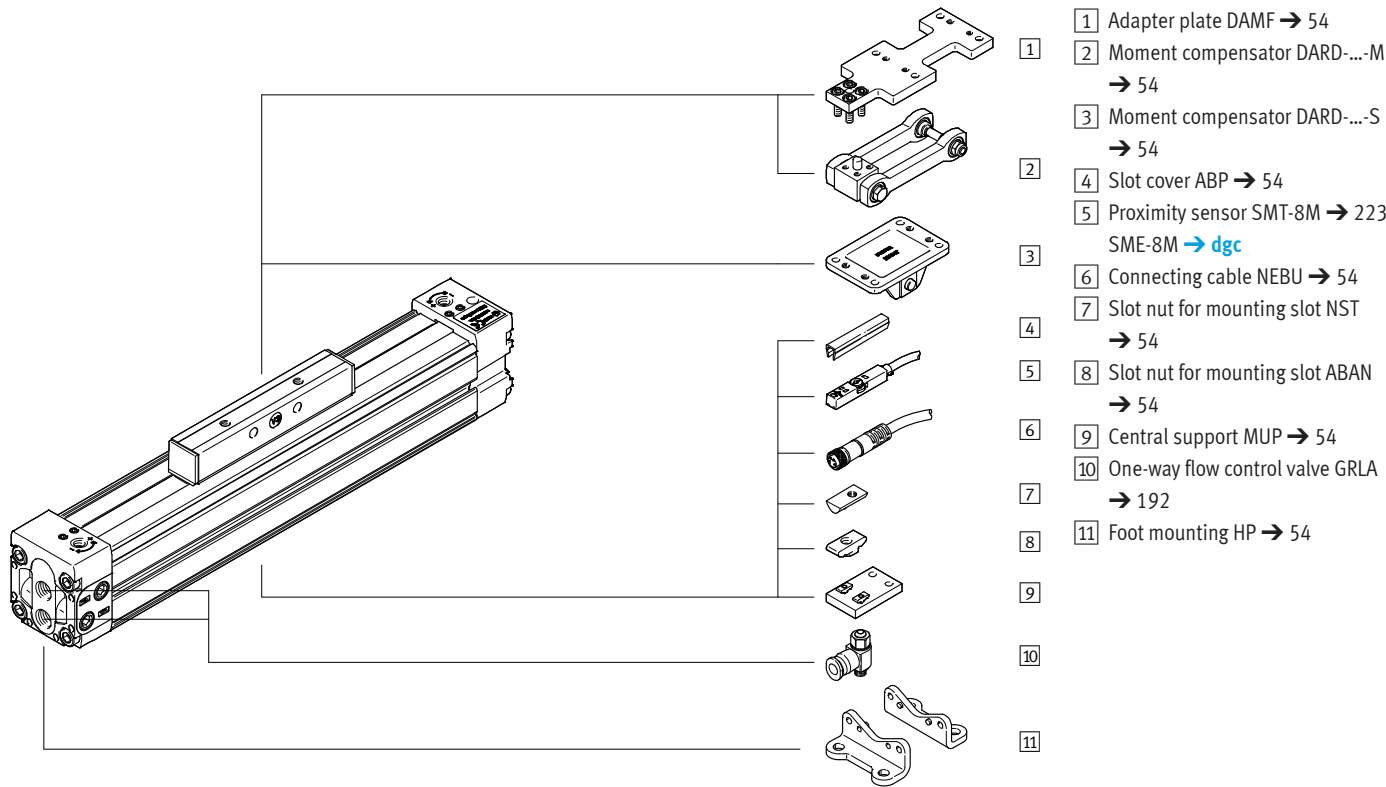

1 Adapter plate DAMF		
For Ø	Type	Part no.
18	DAMF-18-FKP	2349281
25	DAMF-25-FKP	2349282
32	DAMF-32-FKP	2349283
40	DAMF-40-FKP	2349284
50	DAMF-50-FKP	2349285
63	DAMF-63-FKP	2349286
80	DAMF-80-FKP	2349287

3 Moment compensator DARD-...-S		
For Ø	Type	Part no.
18	DARD-L1-18-S	8001411
25	DARD-L1-32-S	8001412
32	DARD-L1-32-S	8001412
40	DARD-L1-40-S	8001413
50	DARD-L1-63-S	8001414
63	DARD-L1-63-S	8001414
80	DARD-L1-80-S	8001415

7 Slot nut NST		
For Ø	Type	Part no.
18, 25	NST-HMV-M4 ^{2),3)}	526091
32, 40	NST-5-M5	150914
50, 63, 80	NST-8-M6	150915

2) Packaging unit 10 pieces.
3) Piston size 18 and 25 cannot be used with DGC-...-D2 (supply port at both ends).

9 Central support MUP		
For Ø	Type	Part no.
18	MUP-18/25	150736
	MUP-18/25-P	1711704
25	MUP-25/25	150736
	MUP-18/25-P	1711704
32	MUP-32	150737
40	MUP-40	150738
50	MUP-50	150739
63	MUP-63	150800
80	MUP-80	158455

2 Moment compensator DARD-...-M		
For Ø	Type	Part no.
18	DARD-L1-18-M	2349274
25	DARD-L1-25-M	2349275
32	DARD-L1-32-M	2349276
40	DARD-L1-40-M	2349277
50	DARD-L1-50-M	2349278
63	DARD-L1-63-M	2349279
80	DARD-L1-80-M	2349280

4 Slot cover ABP ¹⁾		
For Ø	Type	Part no.
For mounting slot		
32, 40	ABP-5	151681
50, 63, 80	ABP-8	151682
For sensor slot		
18 ... 80	ABP-5-S1	563360

1) Packaging unit 2x 0.5 m.

8 Slot nut ABAN		
For Ø	Type	Part no.
18, 25	ABAN-1M4-5 ⁴⁾	8003032

4) Packaging unit 4 pieces.

11 Foot mounting HP		
For Ø	Type	Part no.
18	HP-18	158472
25	HP-25	150731
32	HP-32	150732
40	HP-40	150733
50	HP-50	150734
63	HP-63	150735
80	HP-80	158453

6 Connecting cable NEBU			
Cable length	Connection right	Type	Part no.
Connection left: straight socket, M8x1, 3-pin			
2.5 m	Cable, open end, 3-wire	NEBU-M8G3-K-2.5-LE3	541333
5 m		NEBU-M8G3-K-5-LE3	541334
Connection left: angled socket, M8x1, 3-pin			
2.5 m	Cable, open end, 3-wire	NEBU-M8W3-K-2.5-LE3	541338
5 m		NEBU-M8W3-K-5-LE3	541341
Connection left: straight socket, M12x1, 5-pin			
2.5 m	Cable, open end, 3-wire	NEBU-M12G5-K-2.5-LE3	541363
5 m		NEBU-M12G5-K-5-LE3	541364
Connection left: angled socket, M12x1, 5-pin			
2.5 m	Cable, open end, 3-wire	NEBU-M12W5-K-2.5-LE3	541367
5 m		NEBU-M12W5-K-5-LE3	541370

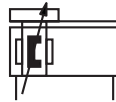

- Compact dimensions
 - Quick and sturdy installation and mounting
 - High precision and load carrying capacity
 - Excellent running characteristics and low air consumption
 - Precision interfaces
 - Many additional features
- Selected types in accordance with ATEX directive for potentially explosive atmospheres
→ www.festo.com/ex

Order code

001	002	003	004	005	006	007	008	009	010	011	012	013	014	015	016
DGC															
															+ ZUB

001	Type
DGC	Double-acting linear actuator
002	Piston Ø [mm]
...	8, 12, 18, 25, 32, 40, 50, 63
003	Stroke [mm]
...	1 ... 8500
004	Guide
G	Basic design
GF	Plain-bearing guide
KF	Recirculating ball bearing guide
FA	Passive guide axis
005	Cushioning
P	Elastic cushioning rings/plates at both ends
PPV	Pneumatic cushioning, adjustable at both ends
YSR	Self-adjusting shock absorber at both ends
YSRW	Self-adjusting progressive shock absorber at both ends
006	Position sensing
A	Via proximity switch
007	Supply port
-	On the right or at both ends
DL	On the left or at both ends
008	Slide
-	Standard
GP	Protected recirculating ball bearing guide
009	Lubrication
-	Standard
H1	Lubrication approved for use in food applications
010	Lubrication function
-	Standard
C	Lubrication adapter

011	Additional slide, left
-	None
KL	Additional slide, standard, left
012	Additional slide, right
-	None
KR	Additional slide, standard, right
013	Clamping unit
-	None
1H	1-channel holding function
014	Actuation type
-	None
PN	Pneumatically actuated
015	EU certification
-	None
EX2	II 3GD in accordance with EU Directive 2014/34/EU
EX3	II 2G in accordance with EU Directive 2014/34/EU
016	Accessories
ZUB -	Accessories enclosed separately
F	Foot mounting (1 piece)
YWZ1	Variable end position, at one end
YWZ2	Variable end position, at both ends
FK	With moment compensator
...V	Connecting cable with plug, 2.5 m (1 ... 10 pieces)
...M	Profile mounting (1 ... 10 pieces)
...G	Proximity switch, N/O with cable, 2.5 m (1 ... 10 pieces)
...H	Proximity switch, N/O with plug (1 ... 10 pieces)
...I	Proximity switch, N/O, contactless with cable, 2.5 m (1 ... 10 pieces)
...J	Proximity switch, N/O, contactless with plug (1 ... 10 pieces)
...L	Slot cover for sensor slot type DGC-G, DGC-GF
...B	Slot cover (1 ... 10 pieces)
Z1	1 intermediate position
Z2	2 intermediate positions
Z3	3 intermediate positions
O	Express waiver – no operating instructions to be included

Legend: Mandatory entry Optional entry

Product options

N NPT thread

Rodless cylinders > Mechanically coupled cylinders >

Linear drives DGC, double-acting

Configurable product

This product and all its product options can be ordered online via the configurator:

→ www.festo.com/catalogue/...

Enter the part number or the type.

Part no.	Type	Part no.	Type
530906	DGC-8-...	532448	DGC-32-...
530907	DGC-12-...	532449	DGC-40-...
532446	DGC-18-...	532450	DGC-50-...
532447	DGC-25-...	532451	DGC-63-...

Accessories

DGC-8/-12

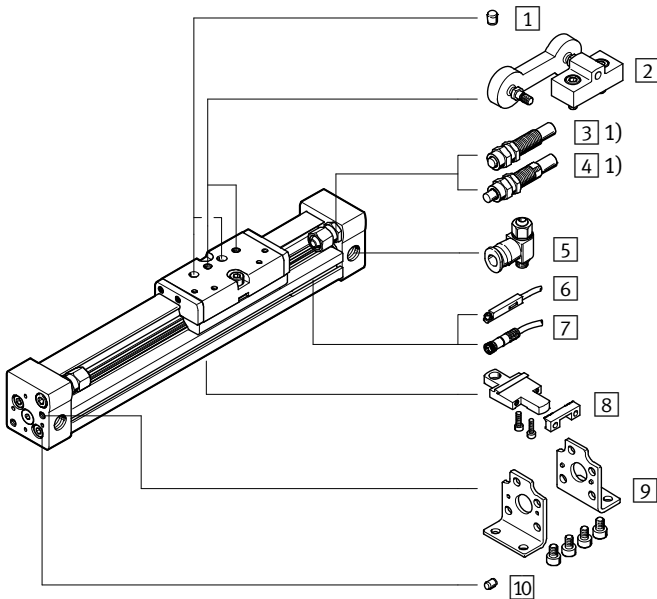

- 1 Centring pin ZBS¹⁾
- 2 Moment compensator FKC → 57
- 3 Shock absorber YSR → [ysr](#)
- 4 Shock absorber YSRW-DGC → 57
- 5 One-way flow control valve GRLA → 192
- 6 Proximity sensor
SME-8M → [dgc](#)
SMT-8M → 223
- 7 Connecting cable NEBU → 57
- 8 Profile mounting MUC → 57
- 9 Foot mounting HPC → 57
- 10 Centring pin/sleeve ZBS/ZBH → 57

1) Included in the scope of delivery of the drive

DGC-18 ... 63

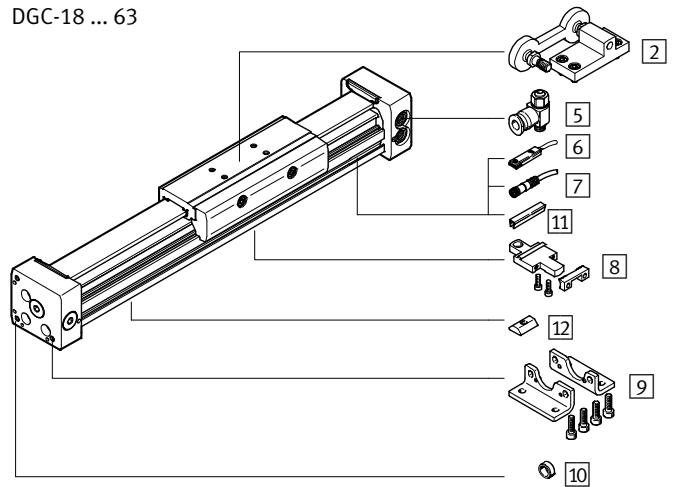

- 7 Connecting cable NEBU → 57
- 8 Profile mounting MUC → 57
- 9 Foot mounting HPC → 57
- 10 Centring pin/sleeve ZBS/ZBH → 57
- 11 Slot cover ABP-S → 57
- 12 Slot nut HMBN → 57

Accessories

2 Moment compensator FKC

For Ø	Type	Part no.
8, 12	FKC-8/12	529350
18	FKC-18	538714
25	FKC-25	538715
32	FKC-32	538961
40	FKC-40	538962
50, 63	FKC-50/63	545240

4 Shock absorber YSRW-DGC

For Ø	Type	Part no.
For DGC-G		
8	YSRW-DGC-8	540344
12	YSRW-DGC-12	540345
For DGC-GF		
18	YSRW-DGC-18-GF	540346
25	YSRW-DGC-25-GF	540348
32	YSRW-DGC-32-GF	540350
40	YSRW-DGC-40-GF	540352
50	YSRW-DGC-40/50-B	1232870
63	YSRW-DGC-63	543069
For DGC-KF		
18	YSRW-DGC-18-KF	540347
25	YSRW-DGC-25-KF	540349
32	YSRW-DGC-32-KF	540351
40, 50	YSRW-DGC-40/50-B	1232870
63	YSRW-DGC-63	543069

7 Connecting cable NEBU

Cable length	Connection right	Type	Part no.
Connection left: straight socket, M8x1, 3-pin			
2.5 m	Cable, open end, 3-wire	NEBU-M8G3-K-2.5-LE3	541333
5 m		NEBU-M8G3-K-5-LE3	541334
Connection left: angled socket, M8x1, 3-pin			
2.5 m	Cable, open end, 3-wire	NEBU-M8W3-K-2.5-LE3	541338
5 m		NEBU-M8W3-K-5-LE3	541341
Connection left: straight socket, M12x1, 5-pin			
2.5 m	Cable, open end, 3-wire	NEBU-M12G5-K-2.5-LE3	541363
5 m		NEBU-M12G5-K-5-LE3	541364
Connection left: angled socket, M12x1, 5-pin			
2.5 m	Cable, open end, 3-wire	NEBU-M12W5-K-2.5-LE3	541367
5 m		NEBU-M12W5-K-5-LE3	541370

8 Profile mounting MUC

For Ø	Type	Part no.
8	MUC-8	526384
12	MUC-12	526387
18	MUC-18	531752
25	MUC-25	531753
32	MUC-32	531754
40	MUC-40	531755
50	MUC-50	531756
63	MUC-63	531757

9 Foot mounting HPC

For Ø	Type	Part no.
8	HPC-8	526385
12	HPC-12	526388
18	HPC-18	533667
25	HPC-25	533668
32	HPC-32	533669
40	HPC-40	533670
50	HPC-50	545236
63	HPC-63	545237

10 Centring pin/sleeve ZBS/ZBH¹⁾

For Ø	Description	Type	Part no.
For DGC-G			
8, 12	For slide	ZBS-5	150928
8, 12	For end cap	ZBS-2	525273
50, 63		ZBH-9	150927
For DGC-GF			
18	For slide	ZBS-5	150928
25 ... 63		ZBH-9	150927
50, 63	For end cap	ZBH-9	150927
For DGC-KF			
8, 12, 18	For slide	ZBS-5	150928
25 ... 63		ZBH-9	150927
8, 12	For end cap	ZBH-2	525273
18		ZBS-5	150928
25 ... 63		ZBH-9	150927

1) Packaging unit 10 pieces.

11 Slot cover ABP-S²⁾

For Ø	Type	Part no.
For sensor slot		
18 ... 63	ABP-5-S	151680

2) Packaging unit 2x 0.5 m.

12 Slot nut HMBN³⁾

For Ø	Type	Part no.
For mounting slot		
25, 32, 40	HMBN-5-1M5	547264
50, 63	HMBN-5-2M5	186566

3) Packaging unit 10 pieces.

Semi-rotary drives > Semi-rotary drives with rotary vane >
Semi-rotary drives DRVS, double-acting

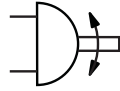

- Modern and compact design
- Lighter than other semi-rotary drives
- Housing protected against splash water and dust
- Selected types in accordance with ATEX directive for potentially explosive atmospheres
→ www.festo.com/ex

Order code – Basic design

001 002 003 004 005
 DRVS - - - P -

Legend: Mandatory entry Optional entry

001	Type
DRVS	Double-acting semi-rotary drive
002	Size
...	6, 8, 12, 16, 25, 32, 40
003	Nominal swivel angle [°]
...	90, 180, 270

004	Cushioning
P	Elastic cushioning rings/plates at both ends
005	EU certification
-	None

Product options

EX4 EU certification (II 2GD)

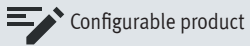

Configurable product
 This product and all its product options can be ordered online via the configurator:
 → www.festo.com/catalogue/drvs

Ordering – Basic design

003 Nominal swivel angle [°]	002 Size						
	6	8	12	16	25	32	40
	004 Elastic cushioning rings/plates at both ends						
	P	P	P	P	P	P	P
90	1845706	1845708	1845710	1845713	1845716	1845719	1845722
180	1845707	1845709	1845711	1845714	1845717	1845720	1845723
270			1845712	1845715	1845718	1845721	1845724

Accessories

Sizes: 6, 8

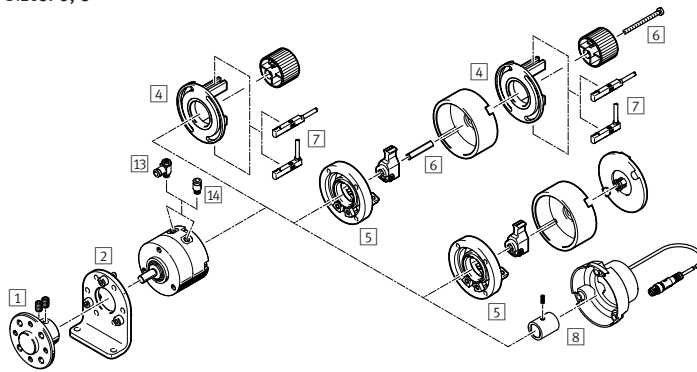

- 1 Push-on flange FWSR/
DARF → [drvs](#)
- 2 Foot mounting DAMH¹⁾ → 59
- 3 Flange mounting DAMF → [drvs](#)
- 4 Mounting kit
WSM-...-SME-10 → 59
- 5 Stop kit KSM → 59
- 6 Adapter kit DADP-AK → 59
- 7 Proximity switch SME/SMT-10
→ [drvs](#)
- 8 Position sensor SRBS → [drvs](#)
- 9 Stop kit DADP-ES → 59

1) Size 6, 8: The foot mounting can only be mounted at the front.

Size 12 ... 40

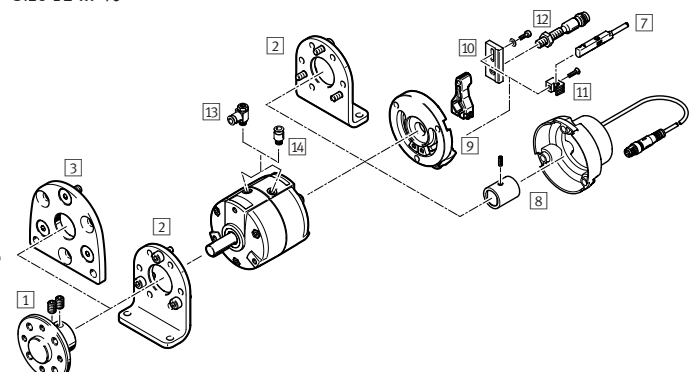

- 10 Sensor bracket SL-DSM-S → [drvs](#)
- 11 Sensor bracket SL-DSM-B → [drvs](#)
- 12 Proximity switch SIEN → 59
Connecting cable NEBU → 59
- 13 One-way flow control valve GRLA
→ 59, 192
- 14 Push-in fitting QS → 293

2 Foot mounting DAMH		
For size	Type	Part no.
6	DAMH-Q12-6	3371840
8	DAMH-Q12-8	3371841
12	DAMH-Q12-12	3371842
16	DAMH-Q12-16	3371843
25	DAMH-Q12-25	3371844
32	DAMH-Q12-32	3371845
40	DAMH-Q12-40	3371846

4 Mounting kit WSM		
For size	Type	Part no.
6	WSM-6-SME-10	173205
8	WSM-8-SME-10	173206

5 Stop kit KSM		
For size	Type	Part no.
6	KSM-6	175833
8	KSM-8	175834

6 Adapter kit DADP-AK		
For size	Type	Part no.
6	DADP-AK-Q1-6	3617044
8	DADP-AK-Q1-8	3617045

9 Stop kit DADP-ES		
For size	Type	Part no.
12	DADP-ES-Q12-12	2536502
16	DADP-ES-Q12-16	2536503
25	DADP-ES-Q12-25	2536504
32	DADP-ES-Q12-32	2536505
40	DADP-ES-Q12-40	2536506

12 Inductive proximity sensor SIEN			
For size	Connection right	Type	Part no.
N/O, M5			
12 ... 40	PNP, cable, 2.5 m	SIEN-M5B-PS-K-L	150370
	PNP, plug	SIEN-M5B-PS-S-L	150371
N/C, M5			
12 ... 40	PNP, cable, 2.5 m	SIEN-M8B-PS-K-L	150386
	PNP, plug	SIEN-M8B-PS-S-L	150387

12 Connecting cable NEBU			
Cable length	Connection on right	Type	Part no.
Connection left: straight socket, M8x1, 3-pin			
2.5 m	Cable, open end, 3-wire	NEBU-M8G3-K-2.5-LE3	541333
5 m		NEBU-M8G3-K-5-LE3	541334
Connection left: angled socket, M8x1, 3-pin			
2.5 m	Cable, open end, 3-wire	NEBU-M8W3-K-2.5-LE3	541338
5 m		NEBU-M8W3-K-5-LE3	541341

13 One-way flow control valves GRLA		
For size	Type	Part no.
6, 8	GRLA-M3-QS-3	175041

Semi-rotary drives > Semi-rotary drives with rack and pinion >

Twin-piston semi-rotary drives DRRD, double-acting

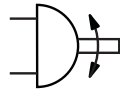

- Extremely accurate in the end positions
- Very high load-bearing capacity
- Very good axial run-out at the flanged shaft
- Very high mass moments of inertia
- Selected types in accordance with ATEX directive for potentially explosive atmospheres
→ www.festo.com/ex

Order code – Basic design

001	002	003	004	005	006
DRRD	-	180	-	FH	-
					A

Legend: Mandatory entry

001	Type
DRRD	Double-acting semi-rotary drive
002	Size
...	16, 20, 25, 32, 35, 40
003	Nominal swivel angle
180	180°
004	Output shaft
FH	Flanged shaft, hollow

005	Cushioning
P	Elastic cushioning rings/plates at both ends
Y9	Linear shock absorber, self-adjusting at both ends
006	Position sensing
A	Via proximity switch

Product options

8, 10, 12, 50, 63 Sizes	P2E2	Energy through-feed: pneumatic, 2 ducts; electric, 2 signals	Y10	Cushioning: linear shock absorber, self-adjusting at both ends, hard, internal	PS1	1 intermediate position
P2 Energy through-feed: pneumatic, 2 ducts	P4E6	Energy through-feed: pneumatic, 4 ducts; electric, 6 signals	Y12	Cushioning: linear shock absorber, self-adjusting at both ends, external	E1	End-position locking at both ends
P4 Energy through-feed: pneumatic, 4 ducts	P8E8	Energy through-feed: pneumatic, 8 ducts; electric, 8 signals	Y14	Linear shock absorber, self-adjusting at both ends, soft	R	Sensor mounting, external: mounting rail for proximity sensor
P8 Energy through-feed: pneumatic, 8 ducts			EX4	EU certification (II 2 GD)	SG	Splash-proof design
					DN	Without operating instructions

Configurable product

This product and all its product options can be ordered online via the configurator:

→ www.festo.com/catalogue/drrd

Ordering – Basic design

005 Elastic cushioning at both ends P		
002 Size	Type	Part no.
16	DRRD-16-180-FH-PA	1577238
20	DRRD-20-180-FH-PA	1395606
25	DRRD-25-180-FH-PA	1359980
32	DRRD-32-180-FH-PA	1578512
35	DRRD-35-180-FH-PA	1526825
40	DRRD-40-180-FH-PA	1503269

005 Linear shock absorber, self-adjusting at both ends, internal Y9		
002 Size	Type	Part no.
16	DRRD-16-180-FH-Y9A	1644389
20	DRRD-20-180-FH-Y9A	1427379
25	DRRD-25-180-FH-Y9A	1360248
32	DRRD-32-180-FH-Y9A	1578518
35	DRRD-35-180-FH-Y9A	1547102
40	DRRD-40-180-FH-Y9A	1526986

Accessories

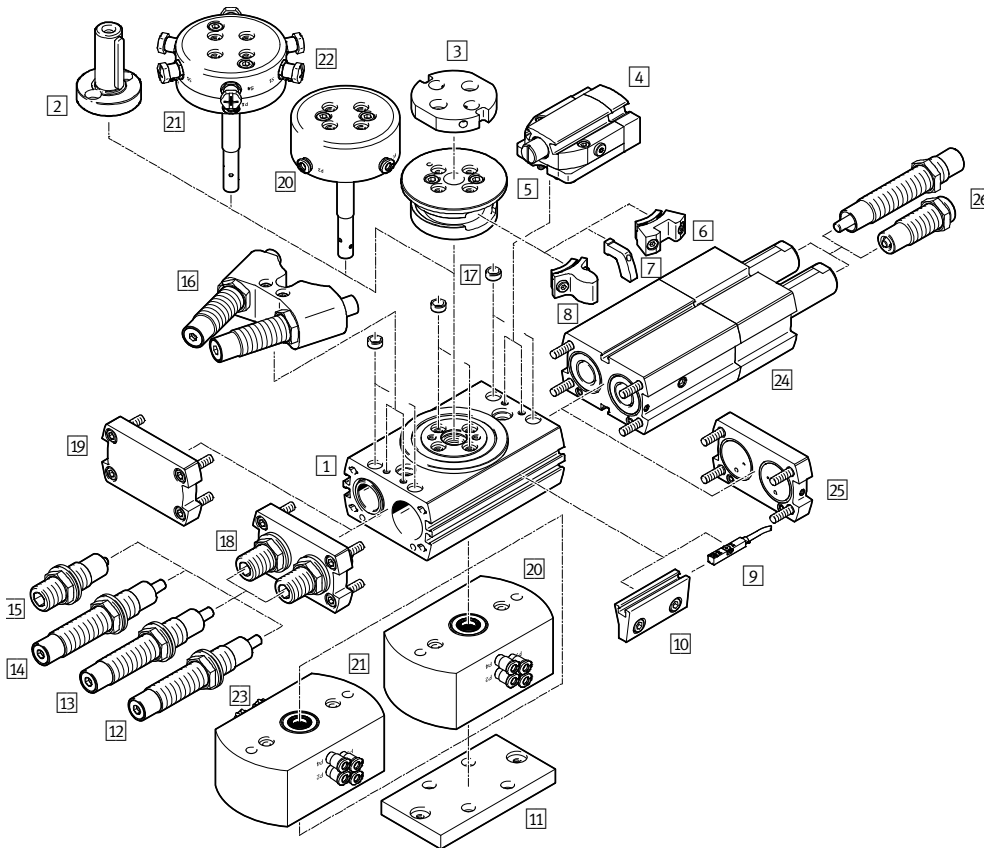

- 1 Semi-rotary drive DRRD → 60
- 2 Drive shaft DARF-Q11 → drrd
- 3 Adapter kit DHAA-G for gripper → drrd
- 4 Clamping unit DADL-...-EL, included in the scope of delivery: 4, 5, 2x6 → drrd
End-position locking, product option E1
- 5 Flange assembly for mounting components 6, 7 and 8
- 6 Clamping component DADL-EC → drrd
- 7 Switch lug DASI-...-SL → drrd
- 8 Stop element, product option Y12
- 9 Proximity sensor SME-8, SME-/SMT-8M → 61
Position transmitter SMAT-8M → drrd

- 10 Sensing kit DASI-...-KT → drrd
Included in the scope of delivery: 5, 2x7, 2x10
Sensor mounting, product option R
- 11 Adapter kit DHAA-D for drives → drrd
- 12 Shock absorber, product option Y9
- 13 Shock absorber, hard, product option Y10
- 14 Shock absorber, soft, product option Y14
- 15 Shock absorber, product option P
- 16 Shock absorber, external, product option Y12, included in the scope of delivery: 5, 2x8, 16
- 17 Centring sleeve ZBH → drrd
- 18 End cap: in combination with elastic cushioning P or shock absorber Y9, Y10, Y14
- 19 End cap: in combination with external shock absorber Y12
- 20 Energy through-feed, pneumatic, product option P2, P4, P8
- 21 Energy through-feed, pneumatic/electric, product option P2E2, P4E6, P8E8
- 22 Connecting cable NEBU from the energy through-feed to the proximity sensor → 61
- 23 Connecting cable NEBU from the energy through-feed to the controller → 61
- 24 Intermediate position, product option PS1
- 25 Connection cap for supply ports
- 26 Shock absorber DYSC-Y1F → drrd
One-way flow control valve GRLA → 61

9 Proximity switch SME-8/SMT-8M, inserted in the slot lengthwise

Description	Type	Part no.
Magnetic reed		
Cable, 2.5 m, 3-wire	SME-8-K-LED-24	150855
Plug M8x1, 3-pin	SME-8-S-LED-24	150857
Magneto-resistive		
Cable, 2.5 m, 3-wire	SMT-8M-A-PS-24V-E-2,5-OE	574335
Plug M8x1, 3-pin	SMT-8M-A-PS-24V-E-0,3-M8D	574334

9 Proximity sensor SME-8M, inserted in the slot from above

Description	Type	Part no.
Magnetic reed		
Cable, 2.5 m, 3-wire	SME-8M-DS-24V-K-2,5-OE	543862
Cable, 5 m, 3-wire	SME-8M-DS-24V-K-5,0-OE	543863
Plug M8x1, 3-pin	SME-8M-DS-24V-K-0,3-M8D	543861

22/23 Connecting cable NEBU, input

Cable length	Connection on right	Type	Part no.
For size 16/20, connection left: straight socket, M8x1, 3-pin			
2.5 m	Cable, open end, 3-wire	NEBU-M8G3-K-2.5-LE3	541333
5 m		NEBU-M8G3-K-5-LE3	541334
For size 25/32/35, connection left: straight socket, M8x1, 4-pin			
2.5 m	Cable, open end, 4-wire	NEBU-M8G4-K-2.5-LE4	541342
5 m		NEBU-M8G4-K-5-LE4	541343
For size 40, connection left: straight socket, M12x1, 5-pin			
2.5 m	Cable, open end, 4-wire	NEBU-M12G5-K-2.5-LE4	550326
5 m		NEBU-M12G5-K-5-LE4	541328

One-way flow control valve GRLA

For size	Type	Part no.
To set the swivel speed		
16 ¹⁾ , 20, 25	GRLA-M5-QS-3-RS-D	197576
	GRLA-M5-QS-4-RS-D	197577
32, 35, 40	GRLA-1/8-RS-B	151169

1) Strongly recommended for this size.

Guided drives > Drives with slide >

Mini slides DGST, double-acting

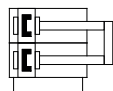

- Very compact design
- Shortest mini slide on the market
- Powerful twin-piston drive
- Very precise recirculating ball bearing guide
- Yoke plate and slide manufactured from a single piece
- Easy end-position adjustment
- Short cycle times and high effective power with twin piston
- High precision and robustness

Order code

001 002 003 004 005
 DGST - - - A

Legend: Mandatory entry

001	Type
DGST	Double-acting mini slide
002	Piston Ø [mm]
...	6, 8, 10, 12, 16, 20, 25
003	Stroke [mm]
...	10, 20, 30, 40, 50, 80, 100, 125, 150, 200

004	Cushioning
E1	Elastomer cushioning, at both ends, stroke not adjustable
P	Elastic cushioning rings/plates at both ends
Y12	Linear shock absorber, self-adjusting at both ends, external
005	Position sensing
A	Via proximity switch

Ordering

003 Stroke [mm]	002 Piston Ø [mm]						
	6	8	10	12	16	20	25
	004 Cushioning E1: elastomer cushioning, at both ends, stroke not adjustable – 005 Position sensing A: via proximity sensor						
10	8078828	8078833	8078839	8078846	8078853	8078862	8078872
20	8078829	8078834	8078840	8078847	8078854	8078863	8078873
30	8078830	8078835	8078841	8078848	8078855	8078864	8078874
40	8078831	8078836	8078842	8078849	8078856	8078865	8078875
50	8078832	8078837	8078843	8078850	8078857	8078866	8078876
80		8078838	8078844	8078851	8078858	8078867	8078877
100			8078845	8078852	8078859	8078868	8078878
125					8078860	8078869	8078879
150					8078861	8078870	8078880
200						8078871	8078881
	004 Cushioning P: elastic cushioning rings/plates at both ends – 005 Position sensing A: via proximity sensor						
10	8085105	8085110	8085116	8085123	8085130	8085139	8085149
20	8085106	8085111	8085117	8085124	8085131	8085140	8085150
30	8085107	8085112	8085118	8085125	8085132	8085141	8085151
40	8085108	8085113	8085119	8085126	8085133	8085142	8085152
50	8085109	8085114	8085120	8085127	8085134	8085143	8085153
80		8085115	8085121	8085128	8085135	8085144	8085154
100			8085122	8085129	8085136	8085145	8085155
125					8085137	8085146	8085156
150					8085138	8085147	8085157
200						8085148	8085158
	004 Cushioning Y12: linear shock absorber, self-adjusting at both ends, external – 005 Position sensing A: via proximity sensor						
30	8085159	8085162	8085166	8085171	8085176	8085183	8085191
40	8085160	8085163	8085167	8085172	8085177	8085184	8085192
50	8085161	8085164	8085168	8085173	8085178	8085185	8085193
80		8085165	8085169	8085174	8085179	8085186	8085194
100			8085170	8085175	8085180	8085187	8085195
125					8085181	8085188	8085196
150					8085182	8085189	8085197
200						8085190	8085198

Accessories

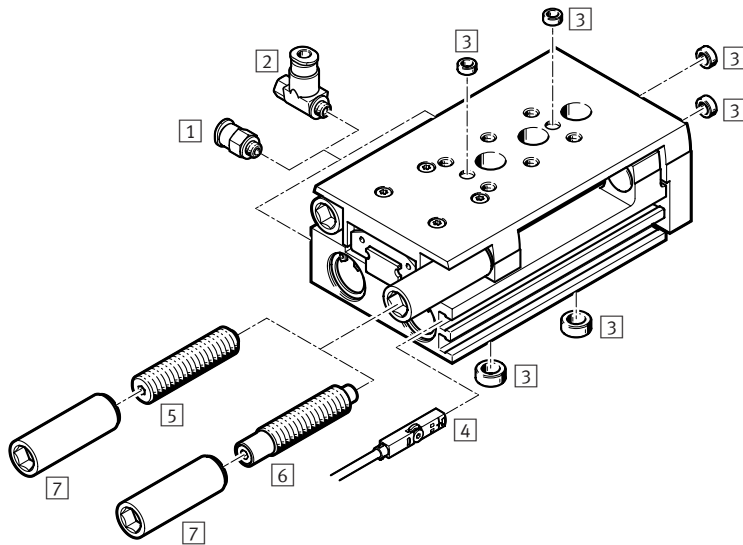

- 1 Push-in fitting QSM → 63
- 2 One-way flow control valve GRLA → 63
- 3 Centring sleeve ZBH → 63
- 4 Proximity switch SMT-10M/SMT-8M → 63
Position transmitter SMAT-8M/SDAT → [dgst](#)
- 5 Shock absorber DYEF (included in the scope of delivery of the mini slide DGST) → 63
- 6 Shock absorber DYSS (included in the scope of delivery of the mini slide DGST) → 63
- 7 Threaded sleeve included in the scope of delivery of the shock absorber 5/6

1 Push-in fitting QSM

For piston Ø [mm]	Type	Part no.
For connecting compressed air tubing with standard outside diameters		
6	QSM-M3-4	153303
8, 10, 12, 16	QSM-M5-4	153304
20, 25	QSM-1/8-6	153307

2 One-way flow control valve GRLA

For piston Ø [mm]	Type	Part no.
For regulating speed		
6	GRLA-M3-QS-3	175041
8, 10, 12, 16	GRLA-M5-QS-6-D	193139
20, 25	GRLA-1/8-QS-8-D	193145

3 Centring sleeve ZBH¹⁾

For piston Ø [mm]	Type	Part no.
For centring loads and attachments on the slide		
6, 8, 10, 12, 16	ZBH-5	189652
20, 25	ZBH-12	189653
For centring loads and attachments on the yoke plate		
6	ZBS-2	525273
8, 10	ZBH-5	189652
12, 16	ZBH-7	186717
20, 25	ZBH-12	189653
For centring the mini slide during mounting		
6, 8	ZBH-5	189652
10, 12	ZBH-7	186717
16	ZBH-9	150927
20, 25	ZBH-12	189653

1) Packaging unit 10 pieces

4 Proximity switch, N/O, magneto-resistive SMT-10M

For piston Ø [mm]	Description	Type	Part no.
PNP, for round slot, inserted in the slot from above			
6, 8, 10, 12	Cable, 3-core, lengthwise, 2.5 m	SMT-10M-PS-24V-E-2,5-L-OE	551373
	Plug M8x1, 3-pin, lengthwise, 0.3 m	SMT-10M-PS-24V-E-0,3-L-M8D	551375
	Plug M8x1, 3-pin, crosswise, 0.3 m	SMT-10M-PS-24V-E-0,3-Q-M8D	551376

4 Proximity switch, N/O, magneto-resistive SMT-8M

For piston Ø [mm]	Description	Type	Part no.
PNP, for T-slot, inserted in the slot from above, flush with the cylinder profile, short version			
16, 20, 25	Cable, 3-wire, 2.5 m	SMT-8M-A-PS-24V-E-2,5-OE	574335
	Plug M8x1, 3-pin, 0.3 m	SMT-8M-A-PS-24V-E-0,3-M8D	574334
NPN, for T-slot, inserted in the slot from above, flush with the cylinder profile, short version			
16, 20, 25	Cable, 3-wire, 2.5 m	SMT-8M-A-NS-24V-E-2,5-OE	574338
	Plug M8x1, 3-pin, 0.3 m	SMT-8M-A-NS-24V-E-0,3-M8D	574339

5 Shock absorber DYEF²⁾

For piston Ø [mm]	Type	Part no.
For DGST-...-P, elastic cushioning at both ends, self-adjusting, with end-position adjustment		
6	DYEF-G8-M4-Y1	8073902
8	DYEF-G8-M5-Y1	8073903
10	DYEF-G8-M6-Y1	8073904
12	DYEF-G8-M8-Y1	8073905
16	DYEF-G8-M10-Y1	8073906
20	DYEF-G8-M12-Y1	8073907
25	DYEF-G8-M14-Y1	8073908

6 Shock absorber DYSS²⁾ with fixed stop

For piston Ø [mm]	Type	Part no.
For DGST-...-Y12, shock absorbers at both ends, self-adjusting, with end-position adjustment		
6	DYSS-G8-2-4-Y1F	8073911
8	DYSS-G8-3-4-Y1F	8073912
10	DYSS-G8-4-4-Y1F	8073913
12	DYSS-G8-5-5-Y1F	8073914
16	DYSS-G8-7-5-Y1F	8073915
20	DYSS-G8-8-8-Y1F	8073916
25	DYSS-G8-10-10-Y1F	8073917

2) Scope of delivery: 1 cushioning component and 1 threaded sleeve Included in the scope of delivery of the mini slide DGST

Guided drives > Drives with guide rods >

Guided drives DFM, double-acting

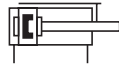

- Drive and guide unit in a single housing
 - Sturdy and precise
 - Plain or recirculating ball bearing guide
 - High resistance to torques and lateral forces
 - Wide range of applications
- Selected types in accordance with ATEX directive for potentially explosive atmospheres
→ www.festo.com/ex

Order code – Basic design

001 002 003 004 005 006
DFM - [] - [] - P - A - []

001	Type
DFM	Double-acting guided drive
002	Piston Ø [mm]
...	6, 10, 12, 16, 20, 25, 32, 40, 50, 63
003	Stroke [mm]
...	5, 10, 15, 20, 25, 30, 40, 50, 80, 100, 125, 160, 200
004	Cushioning
P	Elastic cushioning rings/plates at both ends

Legend: Mandatory entry

005	Position sensing
A	Via proximity switch
006	Guide
GF	Plain-bearing guide
KF	Recirculating ball bearing guide

Product options

80, 100 mm Piston Ø
5 ... 400 mm Variable stroke

PPV Pneumatic cushioning adjustable at both ends
YSRW Self-adjusting, progressive shock absorber, at both ends

S6 Heat-resistant seals up to max. 120 °C
AJ Precision adjustment in the end positions, advanced

EJ Precision adjustment in the end positions, retracted
EX3 II 2G in accordance with EU Directive 2014/34/EU



Configurable product

This product and all its product options can be ordered online via the configurator:

→ www.festo.com/catalogue/dfm

Ordering – Basic design

003 Stroke [mm]	002 Piston Ø [mm]									
	6	10	12	16	20	25	32	40	50	63
	004 Cushioning – 005 Position sensing – 006 Guide									
	P – A – GF	P – A – GF	P – A – GF	P – A – GF	P – A – GF	P – A – GF	P – A – GF	P – A – GF	P – A – GF	P – A – GF
5	4149944	4154768								
10	4149945	4154769	170824	170832						
15	4149946	4154770								
20	4149947	4154799	170825	170833	170840	170847	170854			
25			170826	170834	170841	170848	170855	170864	170871	170878
30			170827	170835	170842	170849	170856			
40			170828	170836	170843	170850	170857			
50			170829	170837	170844	170851	170858	170865	170872	170879
80			170830	170838	170845	170852	170859	170866	170873	170880
100			170831	170839	170846	170853	170860	170867	170874	170881
125							170861	170868	170875	170882
160							170862	170869	170876	170883
200							170863	170870	170877	170884
	004 Cushioning – 005 Position sensing – 006 Guide									
			P – A – KF	P – A – KF	P – A – KF	P – A – KF	P – A – KF	P – A – KF	P – A – KF	P – A – KF
10			170899	170907						
20			170900	170908	170915	170922	170929			
25			170901	170909	170916	170923	170930	170939	170946	170953
30			170902	170910	170917	170924	170931			
40			170903	170911	170918	170925	170932			
50			170904	170912	170919	170926	170933	170940	170947	170954
80			170905	170913	170920	170927	170934	170941	170948	170955
100			170906	170914	170921	170928	170935	170942	170949	170956
125							170936	170943	170950	170957
160							170937	170944	170951	170958
200							170938	170945	170952	170959

Accessories

Piston Ø 6, 10 mm

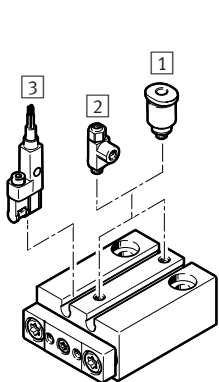

Piston Ø 12 ... 63 mm

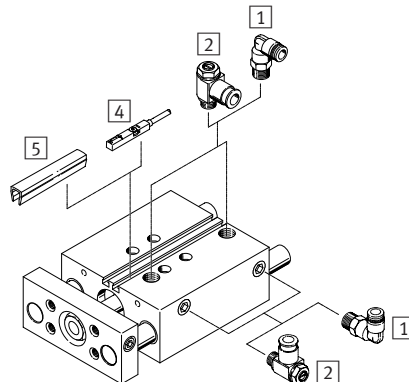

- 1 Push-in fitting QSM/QS → 291, 293
- 2 One-way flow control valve GRLA → 192
- 3 Proximity switch SMT-10G → [dfm](#)
- 4 Proximity switch SME-8M → [dfm](#)
SMT-8M → 223
SME-/SMT-8 → [dfm](#)
- 5 Slot cover ABP-5-S → [dfm](#)

Centring sleeves ZBH for piston Ø 12 ... 63 mm (included in the scope of delivery) → [dfm](#)
Adapters for drive/drive combinations → [dfm](#)

Cylinder mounting parts and accessories for pneumatic drives >

Piston rod attachments SG, SGS, FK

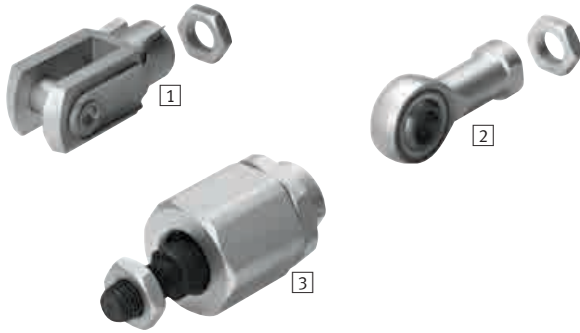

- Coordinated with Festo's cylinder range
- Versatile combinations
- Sturdy and functional
- Stainless-steel variants

- 1 Rod clevis SG: permits a swivelling movement of the cylinder in one plane
- 2 Rod eye SGS: with spherical bearing
- 3 Self-aligning rod coupler FK: for compensating radial and angular deviations

Order code

001 002

-

Legend: Mandatory entry

001	Type
SG	Rod clevis
SGS	Rod eye
FK	Self-aligning rod coupler

002	Piston rod thread
M6	Male thread M6
M8	Male thread M8
M10x1,25	Male thread M10x1.25
M12x1,25	Male thread M12x1.25
M16x1,5	Male thread M16x1.5
M20x1,5	Male thread M20x1.5

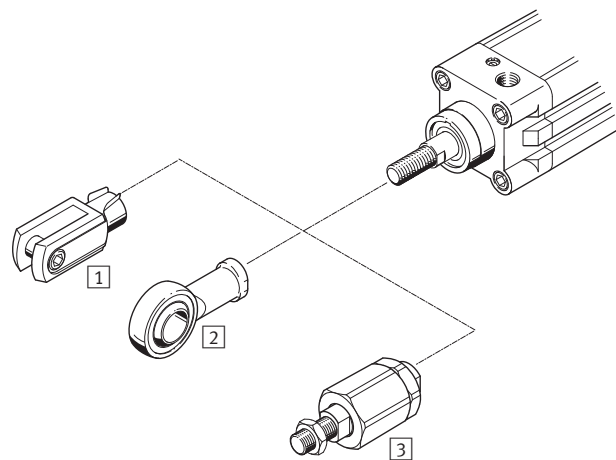

Product options

CRSG Rod clevis in corrosion- and acid-resistant design, conforms to ISO 8140
 CRSGS Rod eye in corrosion- and acid-resistant design, conforms to ISO 12240-4 dimensional series K

CRFK Self-aligning rod coupler in corrosion- and acid-resistant design

Cylinder mounting parts and accessories for pneumatic drives >

Piston rod attachments SG, SGS, FK

Ordering

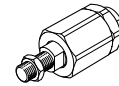
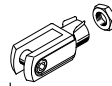

For cylinder	Piston Ø [mm]	002 Piston rod thread	001 Type		
			1 SG	2 SGS	3 FK
ADN → 43	16	M6	3110	9254	2061
	20, 25	M8	3111	9255	2062
	32, 40	M10x1.25	6144	9261	6140
	50, 63	M12x1.25	6145	9262	6141
	80	M16x1.5	6146	9263	6142
DSBC → 33	32	M10x1.25	6144	9261	6140
	40	M12x1.25	6145	9262	6141
	50	M16x1.5	6146	9263	6142
	63	M16x1.5	6146	9263	6142
	80, 100	M20x1.5	6147	9264	6143
DSNU → 29	12, 16	M6	3110	9254	2061
	20	M8	3111	9255	2062
	25, 32	M10x1.25	6144	9261	6140
	40	M12x1.25	6145	9262	6141
DFPC → 336	80, 100	M16x1.5	6146	9263	6142
	125	M20x1.5	6147	9264	6143

02

Electric drives

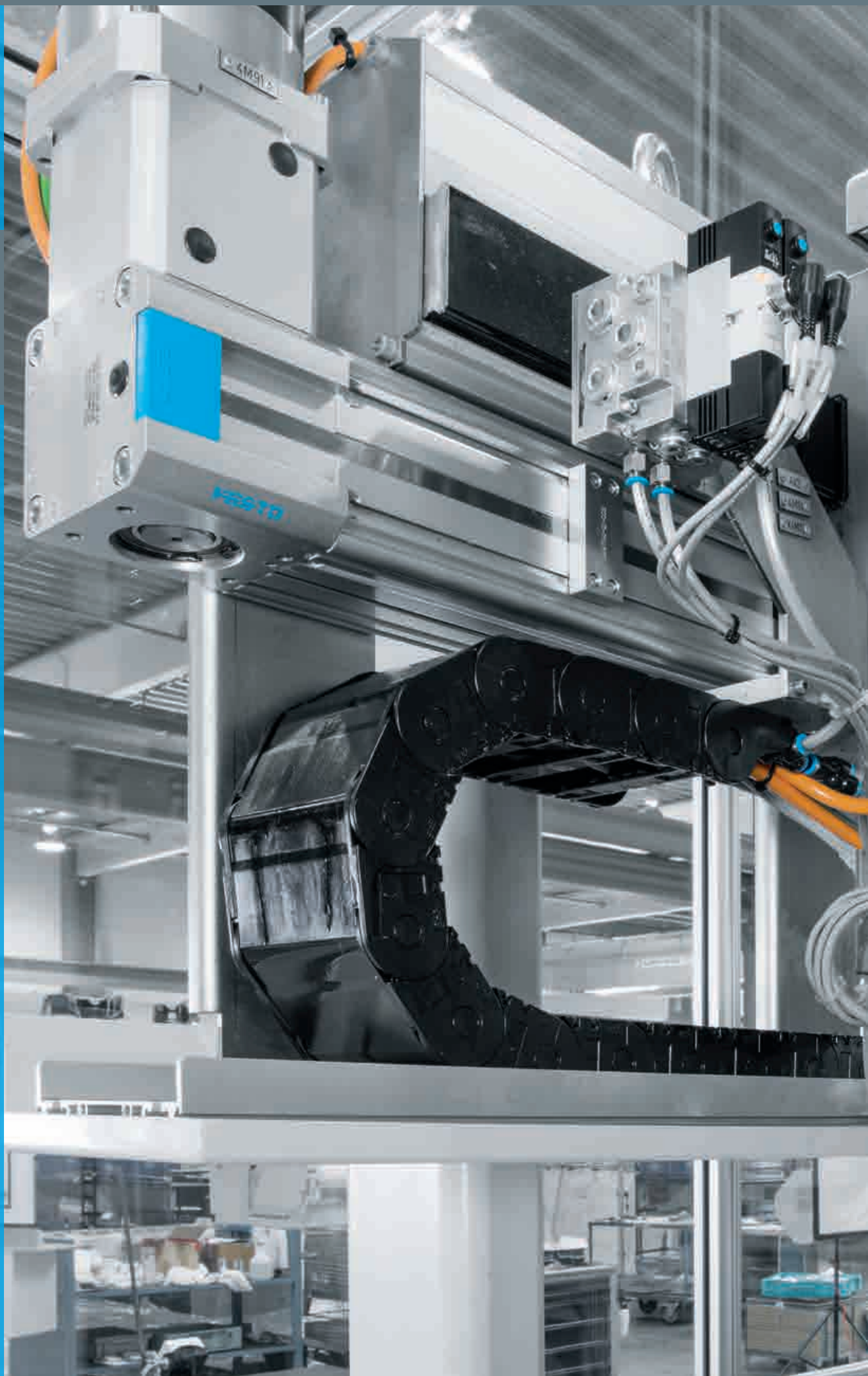

Highlights

Contents



Spindle axes
EGC-BS-KF
+ Spindle support enables maximum travel speed
+ Optionally with clamping unit
→ 81



Electric cylinder with spindle drive
EPCC
+ Low-cost: optimum price/performance ratio
+ Dynamic due to low internal friction
→ 99



Electric cylinders
ESBF
+ High feed forces with compact size
+ Optionally with high corrosion protection
→ 102



Parallel grippers, electric
EHPS
+ Gripping force adjustable at the gripper module
+ Long stroke for different workpieces
→ 75

Product overview _____ 70
Toothed belt axes EGC-TB-KF, with recirculating ball bearing guide _____ 77
Spindle axes EGC-BS-KF, with recirculating ball bearing guide _____ 81
Toothed belt axes ELGC-TB-KF, with recirculating ball bearing guide _____ 85
Spindle axes ELGC-BS-KF, with recirculating ball bearing guide _____ 87
Toothed belt axis units ELGS-TB-KF _____ 89
Spindle axis units ELGS-BS-KF _____ 91
Toothed belt axis units ELGE-TB _____ 94
Electric cylinder units EPCS-BS _____ 96
Electric cylinders EPCC, with spindle drive _____ 99
Electric cylinders ESBF, with spindle drive _____ 102
Mini slides EGSC-BS-KF _____ 106
Mini slide units EGSS-BS-KF _____ 108
Rotary drive units ERMS _____ 110

Product overview

Software-Tools

PositioningDrives: for selecting and sizing electro-mechanical linear drives, motors and gear units







Which electromechanical linear drive, which motor and which gear unit best meets your needs? Enter the data for your application, such as position values, effective loads and mounting position, and the software will suggest several solutions.



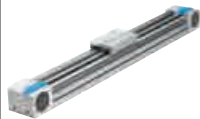

This tool can be found

- on our website at www.festo.com/catalogue by clicking on the blue button 'Engineering'.

Electric axes



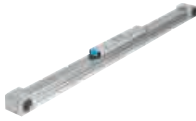

	 Toothed belt axes EGC-TB-KF	 Spindle axes EGC-BS-KF	 Toothed belt axes ELGC-TB-KF	 Spindle axes ELGC-BS-KF
Size	50, 70, 80, 120, 185	70, 80, 120, 185	45, 60, 80	32, 45, 60, 80
Max. feed force Fx	50 ... 2500 N	400 ... 3000 N	75 ... 250 N	40 ... 350 N
Repetition accuracy	+/-0.08 mm, +/-0.1 mm	+/-0.02 mm	+/-0.1 mm	+/-0.01 mm, +/-0.015 mm
Working stroke	50 ... 8500 mm	50 ... 3000 mm	200 ... 2000 mm	100 ... 1000 mm
Description	<ul style="list-style-type: none"> • Axis for high speeds and acceleration • Recirculating ball bearing guide for high loads and torques • Optionally with clamping unit, at one or both ends • Profile with optimised rigidity • 22 types in stock with short delivery time and modular products for individual specifications 	<ul style="list-style-type: none"> • Axis for high repetition accuracy • Recirculating ball bearing guide for high loads and torques • Optionally with clamping unit, at one or both ends • Profile with optimised rigidity • Various spindle pitches • The optional spindle support enables maximum travel speed • Axial or parallel motor mounting 	<ul style="list-style-type: none"> • Precise and resilient guide • Internal guide and toothed belt • Flexible motor connection • The toothed belt axes, spindle axes ELGC and mini slides EGSC form a scalable modular system for compact automation 	<ul style="list-style-type: none"> • Internal guide and ball screw • Space-saving position sensing • Flexible motor mounting • The toothed belt axes, spindle axes ELGC and mini slides EGSC form a scalable modular system for compact automation
→ Page/online	77	81	85	87

Electric axes



	 Toothed belt axes ELGA-TB-G	 Toothed belt axes ELGA-TB-KF	 Toothed belt axes ELGA-TB-RF	 Spindle axes ELGA-BS-KF
Size	70, 80, 120	70, 80, 120, 150	70, 80, 120	70, 80, 120, 150
Max. feed force F_x	350 ... 1300 N	260 ... 2000 N	260 ... 1000 N	650 ... 6400 N
Repetition accuracy	+/-0.08 mm	+/-0.08 mm	+/-0.08 mm	+/-0.02 mm
Working stroke	50 ... 8500 mm	50 ... 8500 mm	50 ... 7400 mm	50 ... 3000 mm
Description	<ul style="list-style-type: none"> • Integrated plain-bearing guide • For small and medium loads • Low guide backlash • Actuator for external guides • Speeds up to 5 m/s with high acceleration up to 50 m/s² • Flexible motor connection • Motor can be mounted on any one of four sides 	<ul style="list-style-type: none"> • Recirculating ball bearing guide for high loads and torques • High feed forces • Precise and resilient guide • Speeds up to 5 m/s with high acceleration up to 50 m/s² • Optional: food-safe (see www.festo.com/sp/elga-tb-kf > "Certificates" tab) • Flexible motor mounting • Guide and toothed belt protected by cover band • 22 types in stock with short delivery time and modular products for custom variants 	<ul style="list-style-type: none"> • Integrated roller bearing guide • High speeds up to 10 m/s with high acceleration up to 50 m/s² • Guide backlash = 0 mm • Very good operating performance under torque load • Sturdy alternative to the recirculating ball bearing guide • As a driving component for external guides, especially for high speeds • Motor can be mounted on any one of four sides 	<ul style="list-style-type: none"> • Internal, precision recirculating ball bearing guide with high load capacity for high torque loads • Guide and ball screw protected by cover band • For the highest requirements in terms of feed force and accuracy • Speeds up to 2 m/s with high acceleration up to 15 m/s² • Space-saving position sensing • Flexible motor mounting • 34 preconfigured types and modular product system for custom variants
→ Page/online	elga	elga	elga	elga

Product overview

Electric axes



	 Toothed belt axis units ELGS-TB-KF	 Spindle axis units ELGS-BS-KF	 Toothed belt axis units ELGE-TB	 Toothed belt axes ELGR
Size	45, 60	32, 45, 60	35	35, 45, 55
Max. feed force F_x	65 ... 75 N	40 ... 200 N	50 N	50 ... 350 N
Repetition accuracy	+/-0.1 mm	+/-0.01 mm, +/-0.015 mm	+/-0.1 mm	+/-0.1 mm
Stroke	50 ... 1500 mm	100 ... 800 mm	50 ... 800 mm	50 ... 1500 mm
Description	<ul style="list-style-type: none"> • Complete solution consisting of integrated drive, motor and servo drive • Resilient toothed belt with long service life • Ideal for precise XY movements, e.g. in assembly plants or when handling small parts as well as for test and inspection systems • Protected against external influences by internal guide • Clean look design: easy to clean and less prone to contamination • Integrated end-position sensing • Two control options integrated as standard: digital I/O and IO-Link® • Easy commissioning according to the plug and work principle: all parameters are manually adjustable directly on the drive without requiring any software or special expertise • Product of the Simplified Motion Series: doesn't need any external servo drive or any control cabinet for the installation 	<ul style="list-style-type: none"> • Complete solution consisting of integrated drive, motor and servo drive • Powerful ball screw • Ideal for precise XY movements, e.g. in assembly plants or when handling small parts as well as for test and inspection systems • Protected against external influences by internal guide • Clean look design: easy to clean and less prone to contamination • Integrated end-position sensing • Two control options integrated as standard: digital I/O and IO-Link® • Easy commissioning according to the plug and work principle: all parameters are manually adjustable directly on the drive without requiring any software or special expertise • Product of the Simplified Motion Series: doesn't need any external servo drive or any control cabinet for the installation 	<ul style="list-style-type: none"> • Complete solution consisting of integrated drive, motor and servo drive • Cost-optimised design for easy motion and positioning tasks between two mechanical end positions • Running performance of 5000 km • Choice of motor mounting position on four sides • Integrated end-position sensing • Two control options integrated as standard: digital I/O and IO-Link® • Easy commissioning according to the plug and work principle: all parameters are manually adjustable directly on the drive without requiring any software or special expertise • Product of the Simplified Motion Series: doesn't need any external servo drive or any control cabinet for the installation 	<ul style="list-style-type: none"> • Optimum price/performance ratio • Ready-to-install unit for quick and easy design • With plain or recirculating ball bearing guide • Motor can be mounted on any one of four sides • Also available as an OMS (Optimised Motion Series) product
→ Page/online	89	91	94	elgr

Electric cylinders and slides



	 Electric cylinder units EPCS-BS	 Electric cylinder units EPCE-TB	 Electric cylinders EPCC-BS
Size	32, 45, 60	45, 60	25, 32, 45, 60
Max. feed force F_x	150 ... 900 N	85 ... 150 N	75 ... 1000 N
Repetition accuracy	+/-0.02 mm	+/-0.05 mm	+/-0.02 mm
Stroke	25 ... 500 mm	10 ... 80 mm	25 ... 500 mm
Description	<ul style="list-style-type: none"> • Complete solution consisting of integrated drive, motor and servo drive • Extremely cost-effective, yet powerful and very flexible • Ideal for individual linear movements in every installation position and especially for vertical Z movements • Precise positioning thanks to smoothly running ball screw • Compact dimensions • Safe movement through flexible position sensing • Integrated end-position sensing • Two control options integrated as standard: digital I/O and IO-Link® • Easy commissioning according to the plug and work principle: all parameters are manually adjustable directly on the drive without requiring any software or special expertise • Product of the Simplified Motion Series: doesn't need any external servo drive or any control cabinet for the installation 	<ul style="list-style-type: none"> • Complete solution consisting of integrated compact cylinder, motor and controller • Cost-optimised design for easy motion and positioning tasks between two mechanical end positions • Minimal zero stroke and extremely compact design make this product the perfect choice for applications where space is at a premium • Innovative interpretation of toothed belt technology for maximum dynamic response and minimal positioning times • Ideal for fast movement in sorting, distribution and testing applications • Up to four piston rods can be selected at the same time in four different mounting positions and different combinations • Integrated end-position sensing • Two control options integrated as standard: digital I/O and IO-Link® • Easy commissioning according to the plug and work principle: all parameters are manually adjustable directly on the drive without requiring any software or special expertise • Product of the Simplified Motion Series: doesn't need any external servo drive or any control cabinet for the installation 	<ul style="list-style-type: none"> • Low-cost: optimum price/performance ratio • Flexible: wide range of mounting options for the motor • Dynamic due to low internal friction • Short positioning times • Weight-optimised design – ideal for handling systems • Unique: "one-size-down" assembly system for excellent use of space
→ Page/online	96	epce	99

Product overview

Electric cylinders and slides

	 Electric cylinders ESBF	 Mini slides EGSC-BS-KF	 Mini slide units EGSS-BS-KF
Size	32, 40, 50, 63, 80, 100	25, 32, 45, 60	32, 45, 60
Max. feed force Fx	600 ... 17000 N	20 ... 250 N	60 ... 250 N
Repetition accuracy	+/-0.01 mm, +/-0.015 mm, +/-0.05 mm	+/-0.015 mm	+/-0.015 mm
Stroke	30 ... 1500 mm	25 ... 200 mm	25 ... 200 mm
Description	<ul style="list-style-type: none"> • Available with ball screw (size 32 ... 100) or lead screw (size 32 ... 50) • Optional: high corrosion protection, degree of protection IP65, food-safe (see www.festo.com/sp/esbf > "Certificates" tab), piston rod extension • Ball screw: three spindle pitches make it possible to select the optimal force-speed ratio • Axial or parallel motor mounting • 68 types in stock with short delivery time and modular products for custom variants 	<ul style="list-style-type: none"> • Precision guide and ball screw • Compact dimensions • Flexible motor mounting • The toothed belt axes, spindle axes ELGC and mini slides EGSC form a scalable modular system for compact automation 	<ul style="list-style-type: none"> • Complete solution consisting of integrated drive, motor and servo drive • For precise vertical Z movements or individual guided linear movements • Very high-quality ball screw with low internal friction • Rigid, high load-bearing and precise linear guide for absorbing lateral forces and increased anti-twist protection • Integrated end-position sensing • Two control options integrated as standard: digital I/O and IO-Link® • Easy commissioning according to the plug and work principle: all parameters are manually adjustable directly on the drive without requiring any software or special expertise • Product of the Simplified Motion Series: doesn't need any external servo drive or any control cabinet for the installation
→ Page/online	102	106	108

Electric semi-rotary drives

	 Rotary drive units ERMS	 Rotary drives ERMO
Size	25, 32	12, 16, 25, 32
Peak torque	2.7... 5.6 Nm	
Nominal torque		0.15 ... 5 Nm
Max. rotational speed	100 ... 150 1/min	100 ... 200 1/min
Nominal speed		50 ... 100 1/min
Rotation angle	90°, 180°, infinite	Infinite
Additional functions	User interface, integrated end-position sensing	
Display	LED	
Description	<ul style="list-style-type: none"> • Complete solution consisting of integrated drive, motor and servo drive • Cost-effective solution package for simple swivel tasks, but also for applications with high loads • Sealed hollow shaft for the integrated through-feed of cables and tubing • Standardised mounting interface for direct connection to the electric mini slides EGSL, EGSC and EGSS • Integrated end-position sensing • Two control options integrated as standard: digital I/O and IO-Link® • Easy commissioning according to the plug and work principle: all parameters are manually adjustable directly on the drive without requiring any software or special expertise • Product of the Simplified Motion Series: doesn't need any external servo drive or any control cabinet for the installation 	<ul style="list-style-type: none"> • Electric rotary drive with stepper motor and integrated gear unit • ServoLite – closed-loop operation with encoder • Heavy-duty bearing for high forces and torques • Backlash-free pre-stressed rotating plate with very good axial eccentricity and concentricity properties • Quick and accurate installation • For simple rotary indexing table applications and as a rotary axis in multi-axis applications • Available as an OMS (Optimised Motion Series) product
→ Page/online	110	ermo

Grippers >

Electric grippers

	 Parallel grippers, electric EHPS
Size	16, 20, 25
Total gripping force at 6 bar, closing	See documentation on our website
Stroke per gripper jaw	10 ... 16 mm
Position sensing	Via proximity switch, with Hall sensor, with displacement encoder integrated, via IO-Link® interface
Gripper repetition accuracy	≤0.01 mm, ≤0.03 mm
Description	<ul style="list-style-type: none"> • Electric version of the pneumatically actuated parallel gripper DHPS • Ideal for use as a front end actuator thanks to its low dead weight • Controller-free actuation using digital signals • Adjustable gripping force (4 settings) • RA1 version with robot connection, enables fast integration in lightweight robot environments
→ Page/online	ehps

Product overview

Customised components – for your specific requirements



Drives with customised designs

Can't find the electromechanical drive you need in our catalogue?

We can offer you customised components that are tailored to your specific requirements.

Common product modifications:

- Special strokes
- Design for special ambient conditions
- Design optimised for the installation space
- Design with carriages moving in opposite directions
- Design with absolute encoder

Many additional variants are possible.

Ask your Festo sales engineer, who will be happy to help:

→ www.festo.com/contact

Toothed belt axes EGC-TB-KF, with recirculating ball bearing guide

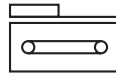

- Recirculating ball bearing guide for high loads and torques
 - Optionally with clamping unit, at one or both ends
 - Profile with optimised rigidity and load capacity
 - Comprehensive range of mounting accessories for multi-axis combinations
 - Precision: the slide position can be sensed directly using the optional displacement encoder
 - Selected types in accordance with ATEX directive for potentially explosive atmospheres
- www.festo.com/ex

Order code

001 002 003 004 005 006 007 008 009 010 011 012 013 014
 EGC - - TB - KF - OH - - - - - - - - - - - - - - -

001	Type	EGC	Linear axis	009	Additional slide, right	-	None
002	Size	...	70, 80, 120	010	Lubrication function	-	None
003	Stroke [mm]	...	300, 400, 500, 600, 800, 1000, 1200	011	Displacement encoder	-	None
004	Function	TB	Toothed belt	012	Clamping unit	-	None
005	Guide	KF	Recirculating ball bearing guide	013	Type of control	-	None
006	Stroke reserve [mm]	OH	None	014	EU certification (ATEX)	-	None
007	Slide	GK	Standard slide				
008	Additional slide, left	-	None				

Legend: Mandatory entry Optional entry

Product options

50, 185 Size	GQ	Extended slide, protected	C	Lubrication adapter	1HL	Clamping unit, 1-channel, left
1 ... 9000 mm Variable stroke	GP	Standard slide, protected	M1	Displacement encoder, incremental, resolution 2.5 µm	1HR	Clamping unit, 1-channel, on right
...H 0 ... 999 mm Stroke reserve	GV	Extended slide	M2	Displacement encoder, incremental, resolution 10 µm	2H	Clamping unit, 2-channel
	KL	Additional slide, left			PN	Pneumatically actuated
	KR	Additional slide, right			EX3	EX3 II 2G to EU Explosion Protection Directive (ATEX)

Configurable product

This product and all its product options can be ordered online via the configurator:
 → www.festo.com/catalogue/...
 Enter the part number or the type.

Part no.	Type	Part no.	Type
556812	EGC-50-...-TB-KF-...	556815	EGC-120-...-TB-KF-...
556813	EGC-70-...-TB-KF-...	556817	EGC-185-...-TB-KF-...
556814	EGC-80-...-TB-KF-...	556818	EGC-240-...-TB-KF-...

Electric axes >

Toothed belt axes EGC-TB-KF, with recirculating ball bearing guide

Ordering – Basic design

004 Toothed belt – 005 Recirculating ball bearing guide – 006 Without stroke reserve – 007 Standard slide – 008 Without additional slide, left – 009 Without additional slide, right – 010 Without lubrication function – 011 Without displacement encoder – 012 Without clamping unit – 013 Without actuation type – 014 Without certification EU (ATEX)

003 Stroke [mm]	002 Size					
	70		80		120	
	Type	Part no.	Type	Part no.	Type	Part no.
300	EGC-70-300-TB-KF-0H-GK	3012492				
400	EGC-70-400-TB-KF-0H-GK	3012493	EGC-80-400-TB-KF-0H-GK	575832	EGC-120-400-TB-KF-0H-GK	3013364
500	EGC-70-500-TB-KF-0H-GK	3012494	EGC-80-500-TB-KF-0H-GK	3013354	EGC-120-500-TB-KF-0H-GK	3013365
600	EGC-70-600-TB-KF-0H-GK	3012495	EGC-80-600-TB-KF-0H-GK	3013355	EGC-120-600-TB-KF-0H-GK	3013366
800	EGC-70-800-TB-KF-0H-GK	3012496	EGC-80-800-TB-KF-0H-GK	3013356	EGC-120-800-TB-KF-0H-GK	3013367
1000	EGC-70-1000-TB-KF-0H-GK	3012497	EGC-80-1000-TB-KF-0H-GK	3013357	EGC-120-1000-TB-KF-0H-GK	3013368
1200	EGC-70-1200-TB-KF-0H-GK	3012498	EGC-80-1200-TB-KF-0H-GK	3013359	EGC-120-1200-TB-KF-0H-GK	3013369
1500					EGC-120-1500-TB-KF-0H-GK	3013370

Accessories

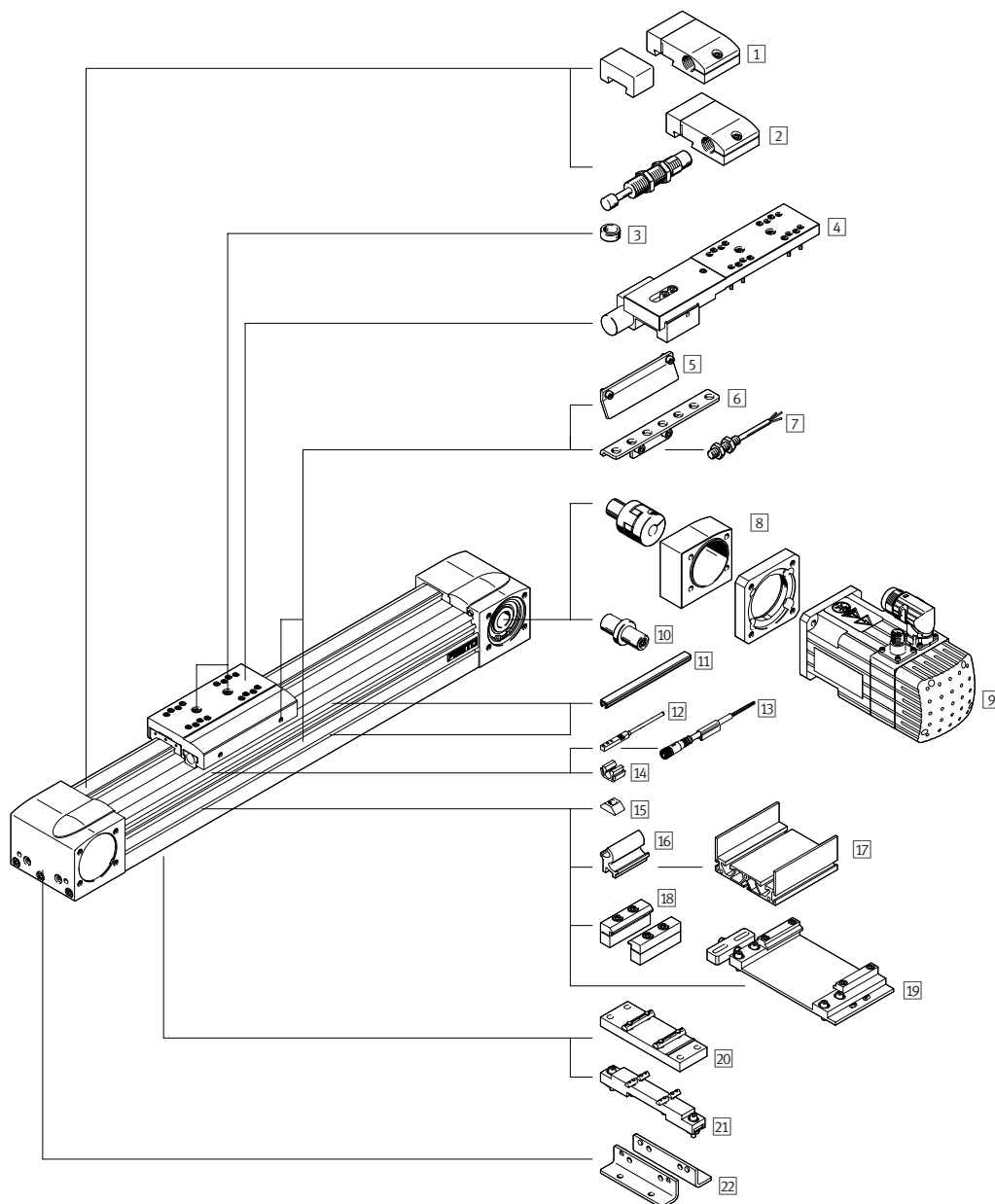

- 1 Emergency buffer NPE/shock absorber retainer KYE → 79
- 2 Shock absorber YSRW/shock absorber retainer KYE → 79
- 3 Centring pin/sleeve ZBS/ZBH → 79
- 4 Clamping unit 1H-P...N, 2H-PN → [egc-tb](#)
- 5 Switch lug SF-EGC → 79
- 6 Sensor bracket HWS-EGC → 79
- 7 Proximity switch, inductive SIEN → 79
- 8 Axial kit EAMM-A → 79
- 9 Motor EMMS → 121
- 10 Drive shaft EAMB → [egc-tb](#)
- 11 Slot cover ABP/ABP-S → 80
- 12 Proximity switch SIES-8M → 80
- 13 Connecting cable NEBU → 80
- 14 Clip SMBK → 80
- 15 Slot nut NST → 80
- 16 Adapter kit DHAM → [egc-tb](#)
- 17 Support profile HMIA → [egc-tb](#)
- 18 Profile mounting MUE → 80
- 19 Adjusting kit EADC-E16 → [egc-tb](#)
- 20 Central support EAHF-L5 → 80
- 21 Adjusting kit EADC-E15 → [egc-tb](#)
- 22 Foot mounting HPE → 80

Guide axis EGC-FA → [egc-fa](#)
 Connecting shaft KSK → [ksk](#)

Toothed belt axes EGC-TB-KF, with recirculating ball bearing guide

Accessories

1 Emergency buffer NPE

For size	Type	Part no.
For use in combination with shock absorber retainer KYE		
70	NPE-70	562581
80	NPE-80	562582
120	NPE-120	562583

1 Shock absorber retainer KYE

For size	Type	Part no.
For avoiding damage at the end stop in the event of malfunction		
70	KYE-70	557584
80	KYE-80	557585
120	KYE-120	557586

2 Shock absorber YSRW

For size	Type	Part no.
For use in combination with shock absorber retainer KYE		
70	YSRW-8-14	191194
80	YSRW-12-20	191196
120	YSRW-16-26	191197

3 Centring pin/sleeve ZBS/ZBH

For size	Type	Part no.
70	ZBS-5 ¹⁾²⁾	150928
80, 120	ZBH-9 ¹⁾²⁾	150927

1) Packaging unit 10 pieces.

2) 2 centring pins/sleeves included in the scope of delivery of the axis.

5 Switch lug SF-EGC

For size	Type	Part no.
For sensing via proximity switch SIES-8M		
70	SF-EGC-1-70	558047
80	SF-EGC-1-80	558048
120	SF-EGC-1-120	558049
For sensing via proximity switch SIEN-M8B		
70	SF-EGC-2-70	558052
80	SF-EGC-2-80	558053
120	SF-EGC-2-120	558054

6 Sensor bracket HWS-EGC

For size	Type	Part no.
For proximity switch SIEN-M8B		
70, 80	HWS-EGC-M5	558057
120	HWS-EGC-M8-B	570365

7 Proximity switch, round design, inductive SIEN-M8B

Description	Type	Part no.	
N/O	PNP, cable, 2.5 m	SIEN-M8B-PS-K-L	150386
	PNP, plug, M8x1	SIEN-M8B-PS-S-L	150387
	NPN, cable, 2.5 m	SIEN-M8B-NS-K-L	150384
	NPN, plug, M8x1	SIEN-M8B-NS-S-L	150385
N/C contact	PNP, cable, 2.5 m	SIEN-M8B-PO-K-L	150390
	PNP, plug, M8x1	SIEN-M8B-PO-S-L	150391
	NPN, cable, 2.5 m	SIEN-M8B-NO-K-L	150388
	NPN, plug, M8x1	SIEN-M8B-NO-S-L	150389

8 Axial kit EAMM-A

For	With motor/gear unit ¹⁾	Type	Part no.
In combination with stepper motor			
50	EMMS-ST-57-...	EAMM-A-L27-57A	560678
70	EMMS-ST-57-...	EAMM-A-L38-57A	560679
	EMMS-ST-87-...	EAMM-A-L38-87A	560680
80	EMMS-ST-87-...	EAMM-A-L48-87A	560683
In combination with stepper motor and gear unit			
50	EMMS-ST-42-...	EAMM-A-L27-40G	557974
	EMGA-40-P-G...-SST-42		
70	EMMS-ST-57-...	EAMM-A-L38-60G	557978
	EMGA-60-P-G...-SST-57		
80	EMMS-ST-57-...	EAMM-A-L48-60G	557983
	EMGA-60-P-G...-SST-57		
120	EMMS-ST-87-...	EAMM-A-L62-80G	557989
	EMGA-80-P-G...-SST-87		
In combination with servo motor			
70	EMMT-AS-60-...	EAMM-A-L38-60P	2037246
	EMME-AS-60-...		
80	EMME-AS-80-...	EAMM-A-L48-80P	2042616
120	EMME-AS-100-...	EAMM-A-L62-100A	557988
	EMMS-AS-100-...		
In combination with servo motor and gear unit			
50	EMME-AS-40-...	EAMM-A-L27-40G	557974
	EMGA-40-P-G...-EAS-40		
	EMMS-AS-40-...		
70	EMMS-AS-55-...	EAMM-A-L38-60G	557978
	EMGA-60-P-G...-SAS-55		
	EMMS-AS-70-...		
80	EMGA-60-P-G...-SAS-70	EAMM-A-L48-60G	557983
	EMMS-AS-55-...		
	EMGA-60-P-G...-SAS-55		
120	EMMS-AS-70-...	EAMM-A-L62-80G	557989
	EMGA-80-P-G...-SAS-70		
	EMME-AS-80-...		
185	EMGA-80-P-G...-EAS-80	EAMM-A-L95-120G-G2	3659941
	EMME-AS-100-...		
	EMGA-80-P-G...-SAS-100		
185	EMMS-AS-100-...	EAMM-A-L95-120G-G2	3659941
	EMGA-120-P-G...-SAS-100		
	EMMS-AS-140-...		
185	EMGA-120-P-G...-SAS-140	EAMM-A-L95-120G-G2	3659941
	EMMS-AS-100-...		
	EMGA-120-P-G...-SAS-100		
In combination with servo motor and right-angle gear unit			
50	EMME-AS-40-...	EAMM-A-L27-40G	557974
	EMGA-40-A-G...-40P		
120	EMME-AS-80-...	EAMM-A-L62-80G	557989
	EMGA-80-A-G...-80P		
120	EMME-AS-100-...	EAMM-A-L62-80G	557989
	EMGA-80-A-G...-100A		

1) The input torque must not exceed the max. permissible transferable torque of the axial kit.

Electric axes >

Toothed belt axes EGC-TB-KF, with recirculating ball bearing guide

Accessories

02 Electric drives

11 Slot cover ABP		
For size	Type	Part no.
For mounting slot, 0.5 m		
70, 80	ABP-5	151681
120	ABP-8	151682
For sensor slot, 0.5 m		
70, 80, 120	ABP-5-S1	563360

12 Proximity switch for T-slot, inductive SIES-8M			
Description		Type	Part no.
N/O contact	PNP, cable, 7.5 m	SIES-8M-PS-24V-K-7,5-OE	551386
	PNP, plug, 0.3 m	SIES-8M-PS-24V-K-0,3-M8D	551387
	NPN, cable, 7.5 m	SIES-8M-NS-24V-K-7,5-OE	551396
	NPN, plug, 0.3 m	SIES-8M-NS-24V-K-0,3-M8D	551397
N/C contact	PNP, cable, 7.5 m	SIES-8M-PO-24V-K-7,5-OE	551391
	PNP, plug, 0.3 m	SIES-8M-PO-24V-K-0,3-M8D	551392
	NPN, cable, 7.5 m	SIES-8M-NO-24V-K-7,5-OE	551401
	NPN, plug, 0.3 m	SIES-8M-NO-24V-K-0,3-M8D	551402

13 Connecting cable NEBU			
Cable length	Connection, right	Type	Part no.
Connection, left: straight socket, M8x1, 3-pin			
2.5 m	Cable, open end, 3-wire	NEBU-M8G3-K-2.5-LE3	541333
5 m		NEBU-M8G3-K-5-LE3	541334
Connection, left: angled socket, M8x1, 3-pin			
2.5 m	Cable, open end, 3-wire	NEBU-M8W3-K-2.5-LE3	541338
5 m		NEBU-M8W3-K-5-LE3	541341

14 Clip SMBK		
For size	Type	Part no.
For sensor slot, for attaching the proximity switch cables		
70, 80, 120	SMBK-8	534254

15 Slot nut NST		
For size	Type	Part no.
70, 80	NST-5-M5	150914
120	NST-8-M6	150915

18 Profile mounting MUE		
For size	Type	Part no.
70, 80	MUE-70/80	558043
120	MUE-120/185	558044

20 Central support EAHF-L5		
For size	Type	Part no.
70	EAHF-L5-70-P	2349256
80	EAHF-L5-80-P	3535188
120	EAHF-L5-120-P	2410274

22 Foot mounting HPE		
For size	Type	Part no.
70	HPE-70	558321
80	HPE-80	558322
120	HPE-120	558323

Spindle axes EGC-BS-KF, with recirculating ball bearing guide

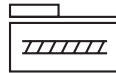

- High speeds and feed forces
- Recirculating ball bearing guide and rigid profile
- Large loads and torques

Order code – Basic design

001	002	003	004	005	006	007	008	009	010	011	012	013	014
EGC			BS	...P		KF	OH	ML	GK				

001	Type
EGC	Linear axis
002	Size
...	70, 80, 120
003	Stroke [mm]
...	100, 200, 300, 400, 500, 600, 800
004	Function
BS	Ball screw
005	Spindle pitch [mm/rev]
10P	10
20P	20
25P	25
006	Spindle support
-	None
007	Guide
KF	Recirculating ball bearing guide

008	Stroke reserve [mm]
OH	None
009	Motor attachment position
ML	Motor on the left
010	Slide
GK	Standard slide
011	Lubrication function
-	None
012	Displacement encoder, incremental
-	None
013	Clamping unit
-	None
014	Actuation type
-	None

Legend: Mandatory entry Optional entry

Product options

185	Size	GQ	Extended slide, protected	C	Lubrication adapter	1HL	Clamping unit, 1-channel, left
1 ...	9000 mm Variable stroke	GP	Standard slide, protected	M1	Displacement encoder, incremental, resolution 2.5 µm	1HR	Clamping unit, 1-channel, on right
40P	Spindle pitch 40 mm/rev	GV	Extended slide	M2	Displacement encoder, incremental, resolution 10 µm	2H	Clamping unit, 2-channel
S	With spindle support	KL	Additional slide, left			PN	Pneumatically actuated
...H	0 ... 999 mm Stroke reserve	KR	Additional slide, right				
MR	Motor on the right						

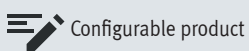

This product and all its product options can be ordered online via the configurator:

→ www.festo.com/catalogue/egc-bs

Electric axes >

Spindle axes EGC-BS-KF, with recirculating ball bearing guide

Ordering – Basic design

004 Ball screw – 006 Without spindle support – 007 Recirculating ball bearing guide – 008 Without stroke reserve – 009 Motor attachment on the left – 010 Standard slide – 011 Without lubrication function – 012 Without displacement encoder – 013 Without clamping unit – 014 Without actuation type

003 Stroke [mm]	002 Size – 005 Spindle pitch				
	70 – 10 mm/rev	80 – 10 mm/rev	80 – 20 mm/rev	120 – 10 mm/rev	120 – 25 mm/rev
100	3013388	3013532	3013539	3013571	3013578
200	3013389	3013533	3013540	3013572	3013579
300	3013390	3013534	3013541	3013573	3013580
400	3013391	3013535	3013542	3013574	3013581
500	3013392	3013536	3013543	3013575	3013582
600	3013393	3013537	3013544	3013576	3013583
800		3013538	3013545	3013577	3013584

Accessories

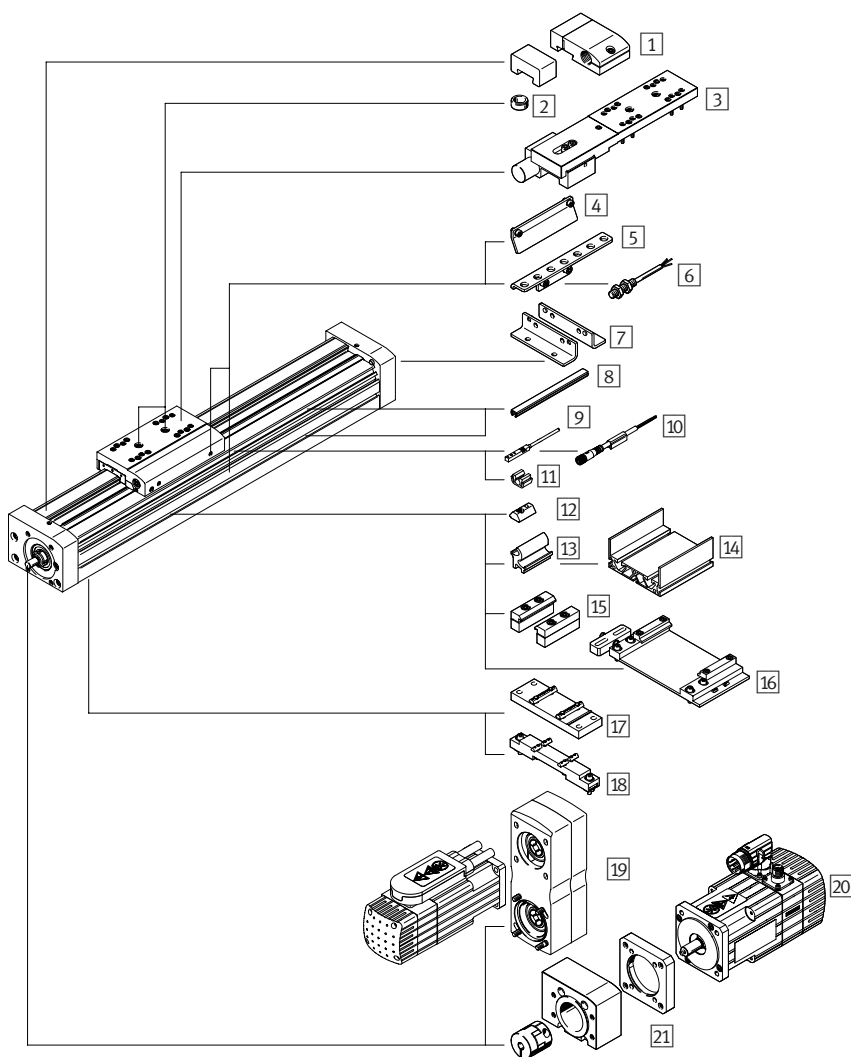

- 1 Emergency buffer NPE with shock absorber retainer KYE → 83
- 2 Centring pin/sleeve ZBS/ZBH → 83
- 3 Clamping unit 1H...-PN, 2H-PN → [egc-bs](#)
- 4 Switch lug SF-EGC → 83
- 5 Sensor bracket HWS-EGC for proximity switch SIEN-M8B → 83
- 6 Proximity switch, round design, inductive SIEN-M8B → 83
- 7 Foot mounting HPE → 83
- 8 Slot cover ABP/ABP-S → 83
- 9 Proximity switch SIES-8M → 83
- 10 Connecting cable NEBU → 83
- 11 Clip SMBK → 83
- 12 Slot nut NST → 83
- 13 Adapter kit DHAM → [egc-bs](#)
- 14 Support profile HMIA → [egc-bs](#)
- 15 Profile mounting MUE → 83
- 16 Adjusting kit EADC-E16 → [egc-bs](#)
- 17 Central support EAHF-L5 → 83
- 18 Adjusting kit EADC-E15 → [egc-bs](#)
- 19 Parallel kit EAMM-U → 84
- 20 Motor EMMS → 121
- 21 Axial kit EAMM-A → 84

Guide axis EGC-FA → [egc-fa](#)

Spindle axes EGC-BS-KF, with recirculating ball bearing guide

Accessories

1 Emergency buffer NPE		
For size	Type	Part no.
For use in combination with shock absorber retainer KYE		
70	NPE-70	562581
80	NPE-80	562582
120	NPE-120	562583

1 Shock absorber retainer KYE		
For size	Type	Part no.
For avoiding damage at the end stop in the event of malfunction		
70	KYE-70	557584
80	KYE-80	557585
120	KYE-120	557586

2 Centring pin/sleeve ZBS/ZBH		
For size	Type	Part no.
70	ZBS-5 ¹⁾²⁾	150928
80, 120	ZBH-9 ¹⁾²⁾	150927

- 1) Packaging unit 10 pieces.
2) 2 centring pins/sleeves included in the scope of delivery of the axis.

4 Switch lug SF-EGC		
For size	Type	Part no.
For sensing via proximity switch SIES-8M		
70	SF-EGC-1-70	558047
80	SF-EGC-1-80	558048
120	SF-EGC-1-120	558049
For sensing via proximity switch SIEN-M8B		
70	SF-EGC-2-70	558052
80	SF-EGC-2-80	558053
120	SF-EGC-2-120	558054

5 Sensor bracket HWS-EGC		
For size	Type	Part no.
For proximity switch SIEN-M8B		
70, 80	HWS-EGC-M5	558057
120	HWS-EGC-M8-B	570365

6 Proximity switch, round design, inductive SIEN-M8B			
Description		Type	Part no.
N/O contact	PNP, cable, 2.5 m	SIEN-M8B-PS-K-L	150386
	PNP, plug, M8x1	SIEN-M8B-PS-S-L	150387
	NPN, cable, 2.5 m	SIEN-M8B-NS-K-L	150384
	NPN, plug, M8x1	SIEN-M8B-NS-S-L	150385
N/C contact	PNP, cable, 2.5 m	SIEN-M8B-PO-K-L	150390
	PNP, plug, M8x1	SIEN-M8B-PO-S-L	150391
	NPN, cable, 2.5 m	SIEN-M8B-NO-K-L	150388
	NPN, plug, M8x1	SIEN-M8B-NO-S-L	150389

7 Foot mounting HPE		
For size	Type	Part no.
70	HPE-70	558321
80	HPE-80	558322
120	HPE-120	558323

8 Slot cover ABP		
For size	Type	Part no.
For mounting slot, 0.5 m		
70, 80	ABP-5	151681
120	ABP-8	151682
For sensor slot, 0.5 m		
70, 80, 120	ABP-5-S1	563360

9 Proximity switch for T-slot, inductive SIES-8M			
Description		Type	Part no.
N/O contact	PNP, cable, 7.5 m	SIES-8M-PS-24V-K-7,5-OE	551386
	PNP, plug, 0.3 m	SIES-8M-PS-24V-K-0,3-M8D	551387
	NPN, cable, 7.5 m	SIES-8M-NS-24V-K-7,5-OE	551396
	NPN, plug, 0.3 m	SIES-8M-NS-24V-K-0,3-M8D	551397
N/C contact	PNP, cable, 7.5 m	SIES-8M-PO-24V-K-7,5-OE	551391
	PNP, plug, 0.3 m	SIES-8M-PO-24V-K-0,3-M8D	551392
	NPN, cable, 7.5 m	SIES-8M-NO-24V-K-7,5-OE	551401
	NPN, plug, 0.3 m	SIES-8M-NO-24V-K-0,3-M8D	551402

10 Connecting cable NEBU			
Cable length	Connection, right	Type	Part no.
Connection, left: straight socket, M8x1, 3-pin			
2.5 m	Cable, open end, 3-wire	NEBU-M8G3-K-2.5-LE3	541333
5 m		NEBU-M8G3-K-5-LE3	541334
Connection, left: angled socket, M8x1, 3-pin			
2.5 m	Cable, open end, 3-wire	NEBU-M8W3-K-2.5-LE3	541338
5 m		NEBU-M8W3-K-5-LE3	541341

11 Clip SMBK		
For size	Type	Part no.
For sensor slot, for attaching the proximity switch cables		
70, 80, 120	SMBK-8	534254

12 Slot nut NST		
For size	Type	Part no.
70, 80	NST-5-M5	150914
120	NST-8-M6	150915

15 Profile mounting MUE		
For size	Type	Part no.
70, 80	MUE-70/80	558043
120	MUE-120/185	558044

17 Central support EAHF-L5		
For size	Type	Part no.
70	EAHF-L5-70-P	2349256
80	EAHF-L5-80-P	3535188
120	EAHF-L5-120-P	2410274

Electric axes >

Spindle axes EGC-BS-KF, with recirculating ball bearing guide

Accessories

02 Electric drives

19 Parallel kit EAMM-U			
For	With motor	Type	Part no.
In combination with stepper motor			
70	EMMS-ST-42-...	EAMM-U-50-S38-42A-78	1217945
	EMMS-ST-57-...	EAMM-U-60-S38-57A-91	1218568
80	EMMS-ST-57-...	EAMM-U-60-S48-57A-91	1219379
	EMMS-ST-87-...	EAMM-U-86-S48-87A-177	1217604
120	EMMS-ST-87-...	EAMM-U-86-S62-87A-177	1217373
In combination with servo motor			
70	EMME-AS-40-...	EAMM-U-50-S38-40P-78	2155239
80	EMMT-AS-60-...	EAMM-U-70-S48-60P-96	2629253
	EMME-AS-60-...		
120	EMME-AS-80-...	EAMM-U-86-S62-80P-177	2157004

21 Axial kit EAMM-A			
For	With motor	Type	Part no.
In combination with stepper motor			
70	EMMS-ST-42-...	EAMM-A-S38-42A-G2	3637965
	EMMS-ST-57-...	EAMM-A-S38-57A-G2	3637956
80	EMMS-ST-57-...	EAMM-A-S48-57A-G2	3637963
	EMMS-ST-87-...	EAMM-A-S48-87A-G2	3637962
120	EMMS-ST-87-...	EAMM-A-S62-87A-G2	3637966
In combination with servo motor			
70	EMME-AS-40-...	EAMM-A-S38-40P-G2	3637972
	EMMT-AS-60-...		
	EMME-AS-60-...		
80	EMMT-AS-60-...	EAMM-A-S48-60P-G2	3637964
	EMME-AS-60-...		
120	EMME-AS-100-...	EAMM-A-S62-100A-G2	3637960
	EMMS-AS-100-...		
	EMME-AS-80-...	EAMM-A-S62-80P-G2	3637970

Toothed belt axes ELGC-TB-KF, with recirculating ball bearing guide

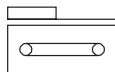

- The toothed belt and spindle axes ELGC together with the mini slides EGSC form a scalable modular system for compact automation
- Internal guide and toothed belt
- Precise and resilient guide
- Flexible motor mounting Selected types in accordance with ATEX directive for potentially explosive atmospheres

→ www.festo.com/ex

Order code

001 002 003 004 005
 ELGC - TB - KF - -

Legend: Mandatory entry

001	Type
ELGC	Toothed belt axis
002	Drive type
TB	Toothed belt
003	Guide
KF	Recirculating ball bearing guide

004	Size
...	45, 60, 80
005	Stroke [mm]
...	200, 300, 500, 600, 800, 1000, 1200, 1500, 1800, 2000

Order

002 Toothed belt – 003 Recirculating ball bearing guide			
005 Stroke [mm]	004 Size		
	45	60	80
200	8062768	8062776	8062786
300	8062769	8062777	8062787
500	8062770	8062778	8062788
600	8062771	8062779	8062789
800	8062772	8062780	8062790
1000	8062773	8062781	8062791
1200	8062774	8062782	8062792
1500	8062775	8062783	8062793
1800		8062784	8062794
2000		8062785	8062795

Electric axes >

Toothed belt axes ELGC-TB-KF, with recirculating ball bearing guide

Accessories

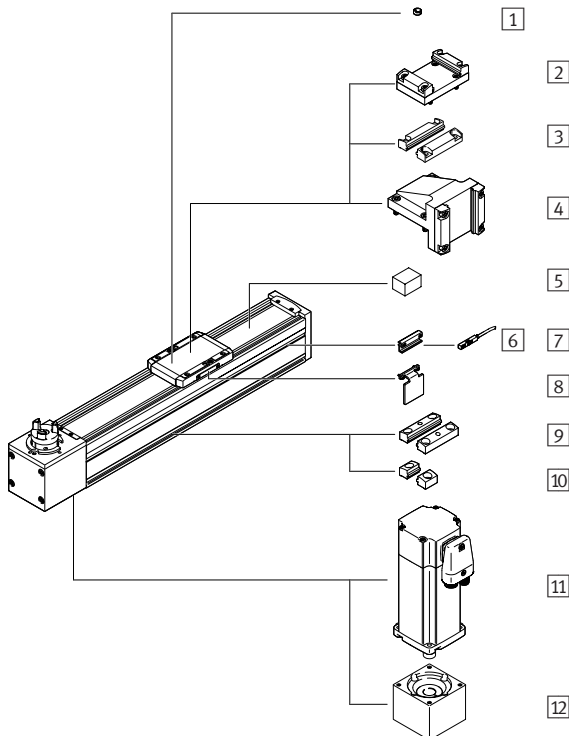

- 1 Centring pin/sleeve ZBS, ZBH → 86
- 2 Adapter kit EHAA-D-L2 → 86
- 3 Profile mounting EAHF-L2-...-P-D... → 86
- 4 Angle kit EHAA-D-L2-...-AP → 86
- 5 Clamping component EADT-S-L5 → 86
- 6 Sensor bracket EAPM-L2-SH → 86
- 7 Proximity switch SIES-8M → 86
Proximity switch SMT-8M → 223
- 8 Switch lug EAPM-L2-SLS → 86
- 9 Profile mounting EAHF-L2-...-P → 86
- 10 Profile mounting EAHF-L2-...-P-S → 86
- 11 Motors EMMS-ST → 121
EMME-AS → [elgc-tb](#)
- 12 Axial kit EAMM-A → [elgc-tb](#)

Electric drives

02

1 Centring pin ZBS/centring sleeve ZBH ¹⁾		
For size	Type	Part no.
45	ZBS-4	562959
60	ZBH-5	189652
80	ZBH-7	186717

1) Packaging unit 10 pieces.

2 Adapter kit EHAA-D-L2		
For combination (size)	Type	Part no.
45/45	EHAA-D-L2-45-L2-45	8066714
60/45, 60/60	EHAA-D-L2-60-L2-60	8066715
80/60, 80/80	EHAA-D-L2-80-L2-80	8066716

3 Profile mounting EAHF-L2-...-P-D...		
For combination (size)	Type	Part no.
60/45	EAHF-L2-45-P-D3	4759739
80/60	EAHF-L2-45-P-D4	4759726

4 Angle kit EHAA-D-L2-...-AP		
For combination (size)	Type	Part no.
60/45	EHAA-D-L2-60-L2-45-AP	8066719
80/60	EHAA-D-L2-80-L2-60-AP	8066720

5 Clamping component EADT-S-L5		
For size	Type	Part no.
45	EADT-S-L5-32	8065818
60, 80	EADT-S-L5-70	8058451

6 Sensor bracket EAPM-L2-SH		
For size	Type	Part no.
45, 60, 80	EAPM-L2-SH	4759852

7 Proximity switch for T-slot, inductive SIES-8M			
Description	Type	Part no.	
N/O contact	PNP, cable, 7.5 m	SIES-8M-PS-24V-K-7,5-OE	551386
	PNP, plug, 0.3 m	SIES-8M-PS-24V-K-0,3-M8D	551387
	NPN, cable, 7.5 m	SIES-8M-NS-24V-K-7,5-OE	551396
	NPN, plug, 0.3 m	SIES-8M-NS-24V-K-0,3-M8D	551397
N/C contact	PNP, cable, 7.5 m	SIES-8M-PO-24V-K-7,5-OE	551391
	PNP, plug, 0.3 m	SIES-8M-PO-24V-K-0,3-M8D	551392
	NPN, cable, 7.5 m	SIES-8M-NO-24V-K-7,5-OE	551401
	NPN, plug, 0.3 m	SIES-8M-NO-24V-K-0,3-M8D	551402

8 Switch lug EAPM-L2-SLS		
For size	Type	Part no.
For sensing using inductive proximity switches SIES-8M		
45	EAPM-L2-45-SLS	8067260
60	EAPM-L2-60-SLS	8067261
80	EAPM-L2-80-SLS	8067262

9 Profile mounting EAHF-L2-...-P		
For size	Type	Part no.
For mounting the axis on the side of the profile		
45, 60, 80	EAHF-L2-45-P	4835728

10 Profile mounting EAHF-L2-...-P-S		
For size	Type	Part no.
For mounting the axis on the side of the profile		
45, 60, 80	EAHF-L2-45-P-S	5184133

Spindle axes ELGC-BS-KF, with recirculating ball bearing guide

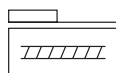

- The toothed belt and spindle axes ELGC together with the mini slides EGSC form a scalable modular system for compact automation
- Internal guide and ball screw
- Space-saving position sensing
- Flexible motor mounting
- Selected types in accordance with ATEX directive for potentially explosive atmospheres

→ www.festo.com/ex

Order code

001 002 003 004 005 006
 ELGC - BS - KF - - - ...P

Legend: Mandatory entry

001	Type
ELGC	Spindle axis
002	Drive system
BS	Ball screw
003	Guide
KF	Recirculating ball bearing guide
004	Size
...	32, 45, 60, 80

005	Stroke [mm]
...	100, 200, 300, 400, 500, 600, 800, 1000
006	Spindle pitch [mm/rev]
8P	8
10P	10
12P	12
16P	16

Order

002 Ball screw – 003 Recirculating ball bearing guide				
005 Stroke [mm] 004 Size – 006 Spindle pitch				
	32 – 8 mm/rev	45 – 10 mm/rev	60 – 12 mm/rev	80 – 16 mm/rev
100	8061477	8061484	8061491	8061498
200	8061478	8061485	8061492	8061499
300	8061479	8061486	8061493	8061500
400	8061480	8061487	8061494	8061501
500	8061481	8061488	8061495	8061502
600	8061482	8061489	8061496	8061503
800	8061483	8061490	8061497	8061504
1000				8061505

Electric axes >

Spindle axes ELGC-BS-KF, with recirculating ball bearing guide

Accessories

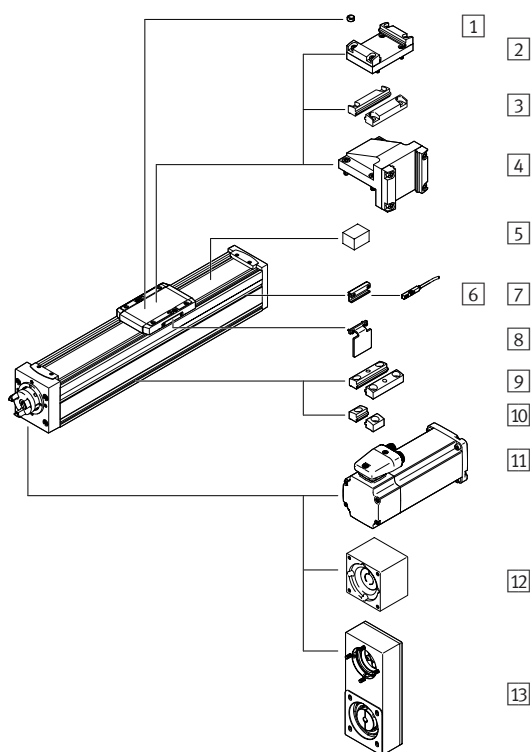

- 1 Centring pin/sleeve ZBS/ZBH → 88
- 2 Adapter kit EHAA-D-L2 → 88
- 3 Profile mounting EAHF-L2-...-P-D... → 88
- 4 Angle kit EHAA-D-L2-...-AP → 88
- 5 Clamping component EADT-S-L5 → 88
- 6 Sensor bracket EAPM-L2-SH → 88
- 7 Proximity switch SIES-8M → 88
Proximity switch SMT-8M → 223
- 8 Switch lug EAPM-L2-...-SLS → 88
- 9 Profile mounting EAHF-L2-...-P → 88
- 10 Profile mounting EAHF-L2-...-P-S → 88
- 11 Motors EMMS-ST → 121
EMME-AS → [elgc-tb](#)
- 12 Axial kit EAMM-A → [elgc-bs](#)
- 13 Parallel kit EAMM-U → [elgc-bs](#)

1 Centring pin/sleeve ZBS/ZBH¹⁾

For size	Description	Type	Part no.
32	For slide	ZBS-2	525273
45		ZBS-4	562959
60		ZBH-5	189652
80		ZBH-7	186717

1) Packaging unit 10 pieces.

2 Adapter kit EHAA-D-L2

For combination (size)	Type	Part no.
3 2/32	EHAA-D-L2-32-L2-32	8066713
45/32, 45/45	EHAA-D-L2-45-L2-45	8066714
60/45, 60/60	EHAA-D-L2-60-L2-60	8066715
80/60, 80/80	EHAA-D-L2-80-L2-80	8066716

3 Profile mounting EAHF-L2-...-P-D...

For combination (size)	Type	Part no.
45/32	EAHF-L2-25-P-D2	4759748
60/45	EAHF-L2-45-P-D3	4759739
80/60	EAHF-L2-45-P-D4	4759726

4 Angle kit EHAA-D-L2-...-AP

For combination (size)	Type	Part no.
45/32	EHAA-D-L2-45-L2-32-AP	8066718
60/45	EHAA-D-L2-60-L2-45-AP	8066719
80/60	EHAA-D-L2-80-L2-60-AP	8066720

5 Clamping component EADT-S-L5

For size	Type	Part no.
32, 45	EADT-S-L5-32	8065818
60, 80	EADT-S-L5-70	8058451

6 Sensor bracket EAPM-L2-SH

For size	Type	Part no.
32, 45, 60, 80	EAPM-L2-SH	4759852

7 Proximity switch for T-slot, inductive SIES-8M

Description	Type	Part no.	
N/O contact	PNP, cable, 7.5 m	SIES-8M-PS-24V-K-7,5-OE	551386
	PNP, plug, 0.3 m	SIES-8M-PS-24V-K-0,3-M8D	551387
	NPN, cable, 7.5 m	SIES-8M-NS-24V-K-7,5-OE	551396
	NPN, plug, 0.3 m	SIES-8M-NS-24V-K-0,3-M8D	551397
N/C contact	PNP, cable, 7.5 m	SIES-8M-PO-24V-K-7,5-OE	551391
	PNP, plug, 0.3 m	SIES-8M-PO-24V-K-0,3-M8D	551392
	NPN, cable, 7.5 m	SIES-8M-NO-24V-K-7,5-OE	551401
	NPN, plug, 0.3 m	SIES-8M-NO-24V-K-0,3-M8D	551402

8 Switch lug EAPM-L2-SLS

For size	Type	Part no.
For sensing using inductive proximity switches SIES-8M		
32	EAPM-L2-32-SLS	8067259
45	EAPM-L2-45-SLS	8067260
60	EAPM-L2-60-SLS	8067261
80	EAPM-L2-80-SLS	8067262

9 Profile mounting EAHF-L2-...-P

For size	Type	Part no.
For mounting the axis on the side of the profile		
32	EAHF-L2-25-P	4835684
45, 60, 80	EAHF-L2-45-P	4835728

10 Profile mounting EAHF-L2-...-P-S

For size	Type	Part no.
For mounting the axis on the side of the profile		
32	EAHF-L2-25-P-S	5183153
45, 60, 80	EAHF-L2-45-P-S	5184133

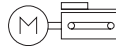

- Without external servo drive: all the necessary electronic components are combined in the integrated drive
- Simplified commissioning: all parameters can be manually set directly on the drive
- Clean look design: easy to clean and less prone to contamination

Order code – Basic design

001	002	003	004	005	006	007	008	009	010	011	012	013
ELGS	TB	KF			ST	M	H1	PLK	AA			

001	Type
ELGS	Gantry axis
002	Drive system
TB	Toothed belt
003	Guide
KF	Recirculating ball bearing guide
004	Size
...	45, 60
005	Stroke [mm]
...	200, 300, 500, 600, 800, 1000, 1200, 1500, 1800, 2000
006	Motor type
ST	Stepper motor
007	Controller
M	Integrated

008	Control panel
H1	Integrated
009	Bus protocol/activation
PLK	PNP and IO-Link®
010	End-position sensing
AA	With integrated end-position sensing
011	Cable outlet direction
–	Standard
012	Electrical accessories
–	None
013	Operating instructions
–	With operating instructions

Legend: Mandatory entry Optional entry

Product options

Bus protocol/activation
NLK NPN and IO-Link®

Cable outlet direction
L Left
R Right
F Front

Electrical accessories
L1 Adapter for operation as IO-Link® device

Operating instructions
DN Without operating instructions

Configurable product

This product and all its product options can be ordered online via the configurator:

→ www.festo.com/catalogue/...

Enter the part number or the type.

Part no.	Type
8083664	ELGS-TB-KF-45-...
8083557	ELGS-TB-KF-60-...

Electric axes >

Toothed belt axis units ELGS-TB-KF

Ordering data – Basic design

002 Toothed belt – 003 Recirculating ball bearing guide – 006 Stepper motor – 007 Integrated controller – 008 Integrated control panel – 009 Bus protocol/activation via PNP and IO-Link® – 010 With integrated end-position sensing – 011 Standard cable outlet – 012 Without electrical accessories – 013 With operating instructions

005 Stroke [mm]	004 Size	
	45	60
200	8083665	8083570
300	8083666	8083571
500	8083667	8083572
600	8083668	8083573
800	8083669	8083574
1000	8083670	8083575
1200	8083671	8083576
1500	8083672	8083577
1800		8083578
2000		8083579

Accessories

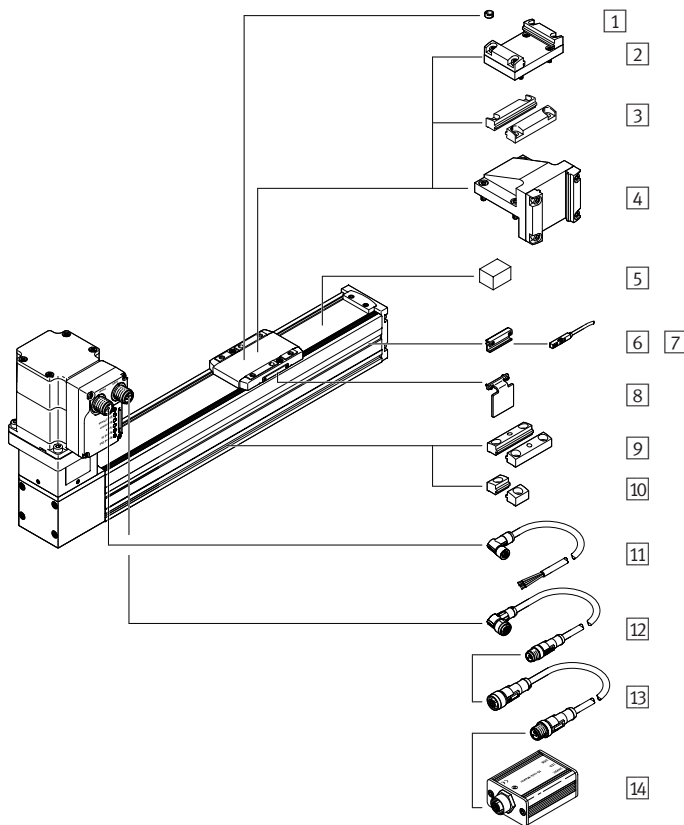

- 1 Centring pin/sleeve ZBS, ZBH → 92
- 2 Adapter kit EHAA-D-L2 → 92
- 3 Profile mounting EAHF-L2-...-P-D → 92
- 4 Angle kit EHAA-D-L2-...-AP → 88
- 5 Clamping component EADT → 92
- 6 Sensor bracket EAPM-L2-SH → 92
- 7 Proximity switch SIES-8M → 93
Proximity switch SMT-8M → 223
- 8 Switch lug EAPM-...-SLS → 93
- 9 Profile mounting EAHF-L2-...-P-S → 90
- 10 Profile mounting EAHF-L2-... → 90
- 11 Supply cable NEBL-T12 → 93
- 12 Connecting cable NEBC-M12 → 93
- 13 Adapter NEFC-M12G8 → 93
- 14 IO-Link® master USB CDSU-1 → 93

9 Profile mounting EAHF-L2-...-P-S		
For size	Type	Part no.
For mounting the axis on the side of the profile		
45, 60	EAHF-L2-45-P-S	5184133

10 Profile mounting EAHF-L2-...-P		
For size	Type	Part no.
For mounting the axis on the side of the profile		
45, 60	EAHF-L2-45-P	4835728

Spindle axis units ELGS-BS-KF

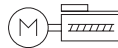

- Without external servo drive: all the necessary electronic components are combined in the integrated drive
- Simplified commissioning: all parameters can be manually set directly on the drive
- Clean look design: easy to clean and less prone to contamination

Order code – Basic design

001 002 003 004 005 006 007 008 009 010 011 012 013 014
 ELGS - BS - KF - [] - [] - ...P - ST - M - H1 - PLK - AA - [] - [] - []

001	Type	009	Control panel
ELGS	Gantry axis	H1	Integrated
002	Drive system	010	Bus protocol/activation
BS	Ball screw	PLK	PNP and IO-Link®
003	Guide	011	End-position sensing
KF	Recirculating ball bearing guide	AA	With integrated end-position sensing
004	Size	012	Cable outlet direction
...	32, 45, 60	-	Standard
005	Stroke [mm]	013	Electrical accessories
...	100, 200, 300, 400, 500, 600, 800	-	None
006	Spindle pitch [mm]	014	Operating instructions
...P	8, 10, 12	-	With operating instructions
007	Motor type		
ST	Stepper motor		
008	Controller		
M	Integrated		

Legend: Mandatory entry Optional entry

Product options

Bus protocol/activation
 NLK NPN and IO-Link®

Cable outlet direction
 D Underneath
 F Front
 B Rear

Electrical accessories
 L1 Adapter for operation as IO-Link® device

Operating instructions
 DN Without operating instructions

Configurable product

This product and all its product options can be ordered online via the configurator:

→ www.festo.com/catalogue/...

Enter the part number or the type.

Part no.	Type
8083433	ELGS-BS-KF-32-...
8083493	ELGS-BS-KF-45-...
8083398	ELGS-BS-KF-60-...

Electric axes >
Spindle axis units ELGS-BS-KF

Ordering data – Basic design

002 Ball screw – 003 Recirculating ball bearing guide – 007 Stepper motor – 008 Integrated controller – 009 Integrated control panel – 010 Bus protocol/activation via PNP and IO-Link® – 011 With integrated end-position sensing – 012 Standard cable outlet – 013 Without electrical accessories – 014 With operating instructions

005 Stroke [mm]	004 Size – 006 Spindle pitch		
	32 – 8 mm/rev	45 – 10 mm/rev	60 – 12 mm/rev
100	8083424	8083470	8083383
200	8083425	8083471	8083384
300	8083426	8083472	8083385
400	8083427	8083473	8083386
500	8083428	8083474	8083387
600	8083429	8083475	8083388
800	8083430	8083476	8083389

Accessories

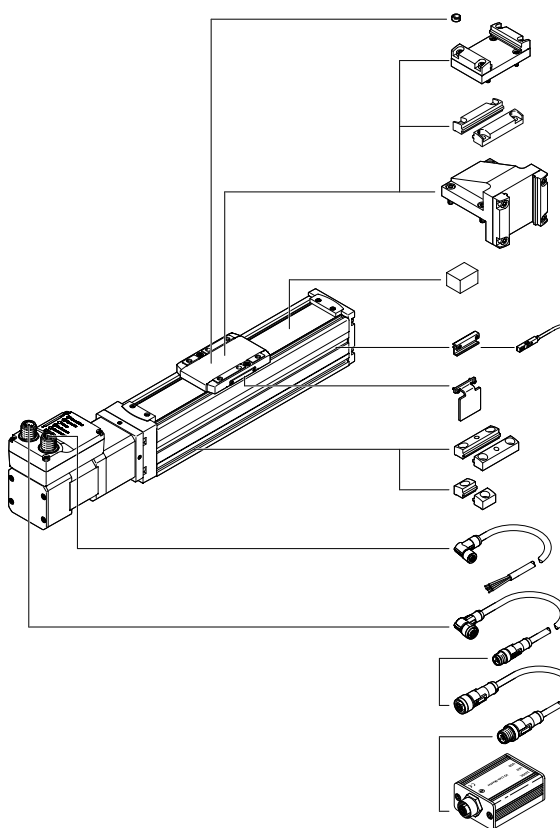

- 1 Centring pin/sleeve ZBS, ZBH → 92
- 2 Adapter kit EHAA-D-L2 → 92
- 3 Profile mounting EAHF-L2-...-P-D → 92
- 4 Angle kit EHAA-D-L2-...-AP → 88
- 5 Clamping component EADT → 92
- 6 Sensor bracket EAPM-L2-SH → 92
- 7 Proximity switch SIES-8M → 93
Proximity switch SMT-8M → 223
- 8 Switch lug EAPM-...-SLS → 93
- 9 Profile mounting EAHF-L2-...-P → 93
- 10 Profile mounting EAHF-L2-...-P-S → 93
- 11 Supply cable NEBL-T12 → 93
- 12 Connecting cable NEBC-M12 → 93
- 13 Adapter NEFC-M12G8 → 93
- 14 IO-Link® master USB CDSU-1 → 93

1 Centring pin ZBS/centring sleeve ZBH ¹⁾			
For size		Type	Part no.
32	For slide	ZBS-2	525273
45		ZBS-4	562959
60		ZBH-5	189652

1) Packaging unit 10 pieces.

2 Adapter kit EHAA-D-L2			
For combination (size)		Type	Part no.
45/32, 45/45		EHAA-D-L2-45-L2-45	8066714
60/45, 60/60		EHAA-D-L2-60-L2-60	8066715

3 Profile mounting EAHF-L2-...-P-D...			
For combination (size)		Type	Part no.
45/32		EAHF-L2-25-P-D2	4759748
60/45		EAHF-L2-45-P-D3	4759739

5 Clamping component EADT			
For size		Type	Part no.
32	Tool for retensioning the cover strip	EADT-S-L5-32	8065818
45		EADT-S-L5-70	8058451
60			

6 Sensor bracket EAPM-L2-SH			
For size		Type	Part no.
32, 45, 60		EAPM-L2-SH	4759852

Accessories

7 Proximity switch for T-slot, inductive SIES-8M

Description	Type	Part no.	
N/O contact	PNP, cable, 7.5 m	SIES-8M-PS-24V-K-7,5-OE	551386
	PNP, plug, 0.3 m	SIES-8M-PS-24V-K-0,3-M8D	551387
	NPN, cable, 7.5 m	SIES-8M-NS-24V-K-7,5-OE	551396
	NPN, plug, 0.3 m	SIES-8M-NS-24V-K-0,3-M8D	551397
N/C contact	PNP, cable, 7.5 m	SIES-8M-PO-24V-K-7,5-OE	551391
	PNP, plug, 0.3 m	SIES-8M-PO-24V-K-0,3-M8D	551392
	NPN, cable, 7.5 m	SIES-8M-NO-24V-K-7,5-OE	551401
	NPN, plug, 0.3 m	SIES-8M-NO-24V-K-0,3-M8D	551402

8 Switch lug EAPM-L2-SLS

For size	Type	Part no.
For sensing using inductive proximity switches SIES-8M		
32	EAPM-L2-32-SLS	8067259
45	EAPM-L2-45-SLS	8067260
60	EAPM-L2-60-SLS	8067261

9 Profile mounting EAHF-L2-...-P

For size	Type	Part no.
For mounting the axis on the side of the profile		
32	EAHF-L2-25-P	4835684
45, 60	EAHF-L2-45-P	4835728

10 Profile mounting EAHF-L2-...-P-S

For size	Type	Part no.
For mounting the axis on the side of the profile		
32	EAHF-L2-25-P-S	5183153
45, 60	EAHF-L2-45-P-S	5184133

11 Supply cable NEBL-T12

Cable length	Connection, right	Type	Part no.
Connection, left: angled socket, M12x1, 4-pin			
2 m	Cable, open end, 4-wire	NEBL-T12W4-E-2-N-LE4	8080778
5 m		NEBL-T12W4-E-5-N-LE4	8080779
10 m		NEBL-T12W4-E-10-N-LE4	8080780
15 m		NEBL-T12W4-E-15-N-LE4	8080781
Connection, left: straight socket, M12x1, 4-pin			
2 m	Cable, open end, 4-wire	NEBL-T12G4-E-2-N-LE4	8080790
5 m		NEBL-T12G4-E-5-N-LE4	8080791
10 m		NEBL-T12G4-E-10-N-LE4	8080792
15 m		NEBL-T12G4-E-15-N-LE4	8080793

12 Connecting cable NEBC-M12

Cable length	Connection, right	Type	Part no.
Connection, left: angled socket, M12x1, 8-pin			
2 m	Cable, open end, 8-wire	NEBC-M12W8-E-2-N-B-LE8	8094476
5 m		NEBC-M12W8-E-5-N-B-LE8	8094478
10 m		NEBC-M12W8-E-10-N-B-LE8	8094481
15 m		NEBC-M12W8-E-15-N-B-LE8	8094479
2 m	Straight connector, M12x1, 8-pin	NEBC-M12W8-E-2-N-M12G8	8080786
5 m		NEBC-M12W8-E-5-N-M12G8	8080787
10 m		NEBC-M12W8-E-10-N-M12G8	8080788
15 m		NEBC-M12W8-E-15-N-M12G8	8080789
Connection, left: straight socket, M12x1, 8-pin			
2 m	Cable, open end, 8-wire	NEBC-M12G8-E-2-N-B-LE8	8094480
5 m		NEBC-M12G8-E-5-N-B-LE8	8094477
10 m		NEBC-M12G8-E-10-N-B-LE8	8094482
15 m		NEBC-M12G8-E-15-N-B-LE8	8094475
2 m	Straight connector, M12x1, 8-pin	NEBC-M12G8-E-2-N-M12G8	8080782
5 m		NEBC-M12G8-E-5-N-M12G8	8080783
10 m		NEBC-M12G8-E-10-N-M12G8	8080784
15 m		NEBC-M12G8-E-15-N-M12G8	8080785

13 Adapter NEFC-M12G8

Cable length	Connection, right	Type	Part no.
Connection, left: straight socket, M12x1, 8-pin			
0.3 m	Straight connector, M12x1, 5-pin	NEFC-M12G8-0.3-M12G5-LK	8080777

14 IO-Link® master USB CDSU-1

Cable length	Type	Part no.
For using the unit with IO-Link®		
0.3 m	CDSU-1	8091509

Electric axes >

Toothed belt axis units ELGE-TB

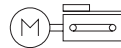

- Without external servo drive: all the necessary electronic components are combined in the integrated drive
- Simplified commissioning: all parameters can be manually set directly on the drive
- Choice of motor mounting position on four sides
- Cost-optimised design for tasks that require simpler yet highly cost-efficient solutions with a service life of 5000 km

Order code – Basic design

001 002 003 004 005 006 007 008 009 010 011 012 013 014 015 016 017 018 019
 ELGE - TB - 35 - OH - ST - M - H1 - PLK - AA - AT - FR - - - - -

001	Type
ELGE	Gantry axis
002	Drive system
TB	Toothed belt
003	Guide
-	Recirculating ball bearing guide
004	Size
35	35
005	Stroke [mm]
...	100, 200, 300, 400, 500, 600
006	Stroke reserve [mm]
OH	0
007	Motor type
ST	Stepper motor
008	Controller
M	Integrated
009	Control panel
H1	Integrated
010	Bus protocol/activation
PLK	PNP and IO-Link®

011	End-position sensing
AA	With integrated end-position sensing
012	Cable outlet direction
AT	Top
013	Motor position
FR	Front right
014	Profile mounting
-	None
015	Proximity switch, inductive, slot 8, N/O contact, cable 7.5 m
-	None
016	Proximity switch, inductive, slot 8, N/C contact, cable 7.5 m
-	None
017	Slot nut for mounting slot
-	None
018	Electrical accessories
-	None
019	Operating instructions
-	With operating instructions

Legend: Mandatory entry Optional entry

Product options

Stroke 50, 150, 250, 350, 450, 550, 650, 700, 750, 800

Bus protocol/activation NLK NPN and IO-Link®

Cable outlet direction
 AD Underneath
 AL Left
 AR Right

Motor position
 FL Front left
 RL Rear left
 RR Rear right

Profile mounting
 ...MA 1, 2

Proximity switch, inductive, slot 8, N/O contact, cable 7.5 m
 ...SA 1 ... 6

Proximity switch, inductive, slot 8, N/C contact, cable 7.5 m
 ...SB 1 ... 6

Slot nut for mounting slot
 ...NM 1 ... 99

Electrical accessories
 L1 Adapter for operation as IO-Link® device

Operating instructions
 DN Without operating instructions

Ordering – Product options

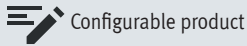

Configurable product

This product and all its product options can be ordered online via the configurator:

→ www.festo.com/catalogue/...

Enter the part number or the type.

Part no.	Type
8083929	ELGE-TB-35-...

Ordering – Basic design

002 Toothed belt – 003 Recirculating ball bearing guide – 006 Stroke reserve 0 mm – 007 Stepper motor – 008 Integrated controller – 009 Integrated control panel – 010 Bus protocol/activation via PNP and IO-Link® – 011 With integrated end-position sensing – 012 Cable outlet to the top – 013 Front right motor position – 014 Without profile mounting – 015, 016 Without proximity switch – 017 Without slot nut, mounting slot – 018 Without electrical accessories – 019 With operating instructions

005 Stroke [mm]	004 Size	Part no.
	35	
	Type	
100	ELGE-TB-35-100-OH-ST-M-H1-PLK-AA-AT-FR	8083931
200	ELGE-TB-35-200-OH-ST-M-H1-PLK-AA-AT-FR	8083932
300	ELGE-TB-35-300-OH-ST-M-H1-PLK-AA-AT-FR	8083933
400	ELGE-TB-35-400-OH-ST-M-H1-PLK-AA-AT-FR	8083934
500	ELGE-TB-35-500-OH-ST-M-H1-PLK-AA-AT-FR	8083935
600	ELGE-TB-35-600-OH-ST-M-H1-PLK-AA-AT-FR	8083936

Accessories

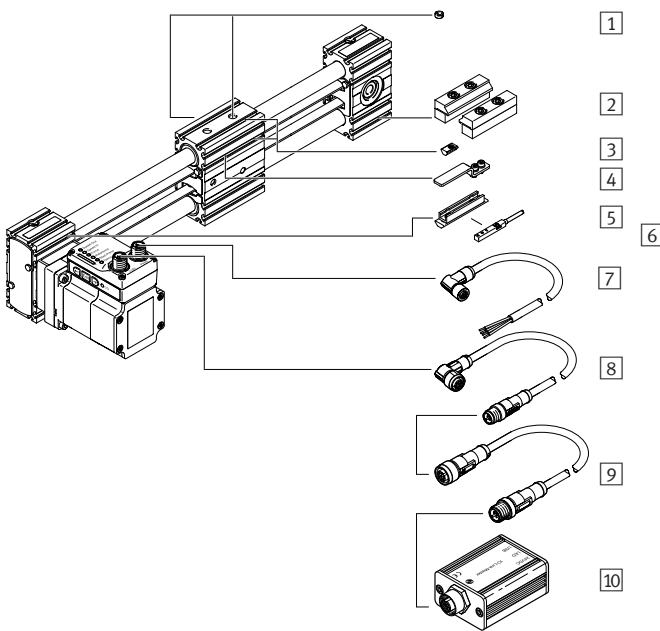

- 1 Centring sleeve ZHB → 95
- 2 Profile mounting MUE → 95
- 3 Slot nut NST → 95
- 4 Switch lug EAPM-L4-SLS → 95
- 5 Sensor bracket EAPM-L4-SHS → 95
- 6 Proximity switch SIES-8M → 93
- 7 Supply cable NEBL-T12 → 93
- 8 Connecting cable NEBC-M12 → 93
- 9 Adapter NEFC-M12G8 → 93
- 10 IO-Link® master USB CDSU-1 → 93

1 Centring sleeve ZBH ¹⁾			
For size	Type	Part no.	
35	For slide	ZBH-7 ²⁾	186717

1) 2 centring sleeves included in the scope of delivery of the axis.
2) Packaging unit 10 pieces.

2 Profile mounting MUE			
For size	Type	Part no.	
35	MUE-50	558042	

3 Slot nut NST			
For size	Type	Part no.	
35	For mounting slot	NST-3-M3	558045

4 Switch lug EAPM-L4-SLS			
For size	Type	Part no.	
35	EAPM-L4-SLS	567538	

5 Sensor bracket EAPM-L4-SHS			
For size	Type	Part no.	
35	EAPM-L4-SHS	567537	

Electric cylinders and slides >
Electric cylinder units EPCS-BS

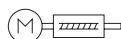

- Without external servo drive: all the necessary electronic components are combined in the integrated drive
- Simplified commissioning: all parameters can be manually set directly on the drive
- Two control options integrated as standard: digital I/O and IO-Link®
- Complete solution for simple movements between mechanical end positions
- Ideal for precise and fast movement in sorting, distribution or clamping applications

Order code – Basic design

001 002 003 004 005 006 007 008 009 010 011 012 013 014
EPCS - BS - [] - [] - ...P - A - ST - M - H1 - PLK - AA - [] - [] - []

001	Type
EPCS	Electric cylinders
002	Drive system
BS	Ball screw
003	Size
32	32
45	45
60	60
004	Stroke [mm]
...	50, 100, 150, 200, 250, 300, 350, 400, 500
005	Spindle pitch [mm]
...P	3, 5, 8, 10, 12
006	Position sensing
A	Via proximity switch
007	Motor type
ST	Stepper motor ST
008	Controller

M	Integrated
009	Control panel
H1	Integrated
010	Bus protocol/activation
PLK	PNP and IO-Link®
011	End-position sensing
AA	With integrated end-position sensing
012	Cable outlet direction
-	Standard
013	Electrical accessories
-	None
014	Operating instructions
-	With operating instructions

Legend: Mandatory entry Optional entry

Product options

Stroke 25, 75, 125, 175	Cable outlet direction D Underneath L Left R Right	Electrical accessories L1 Adapter for operation as IO-Link® device	Operating instructions DN No operating instructions
Bus protocol/activation NLK NPN and IO-Link®			

Ordering – Product options

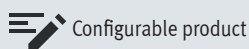

This product and all its product options can be ordered online via the configurator:

→ www.festo.com/catalogue/...

Enter the part number or the type.

Part no.	Type
8118264	EPCS-BS-32-...
8118265	EPCS-BS-45-...
8118266	EPCS-BS-60-...

Ordering data – Basic design

002 Ball screw – 006 Position sensing via proximity switch – 007 Stepper motor ST – 008 Integrated controller – 009 Integrated control panel – 010 Bus protocol PNP and activation via IO-Link® – 011 With integrated end-position sensing – 012 Standard cable outlet orientation – 013 Without electrical accessories – 014 With operating instructions

004 Stroke [mm]	003 Size – 005 Spindle pitch					
	32 – 3 mm/rev	32 – 8 mm/rev	45 – 3 mm/rev	45 – 10 mm/rev	60 – 5 mm/rev	60 – 12 mm/rev
50	8118267	8118271	8118275	8118281	8118287	8118296
100	8118268	8118272	8118276	8118282	8118288	8118297
150	8118269	8118273	8118277	8118283	8118289	8118298
200	8118270	8118274	8118278	8118284	8118290	8118299
250			8118279	8118285	8118291	8118300
300			8118280	8118286	8118292	8118301
350					8118293	8118302
400					8118294	8118303
500					8118295	8118304

Accessories

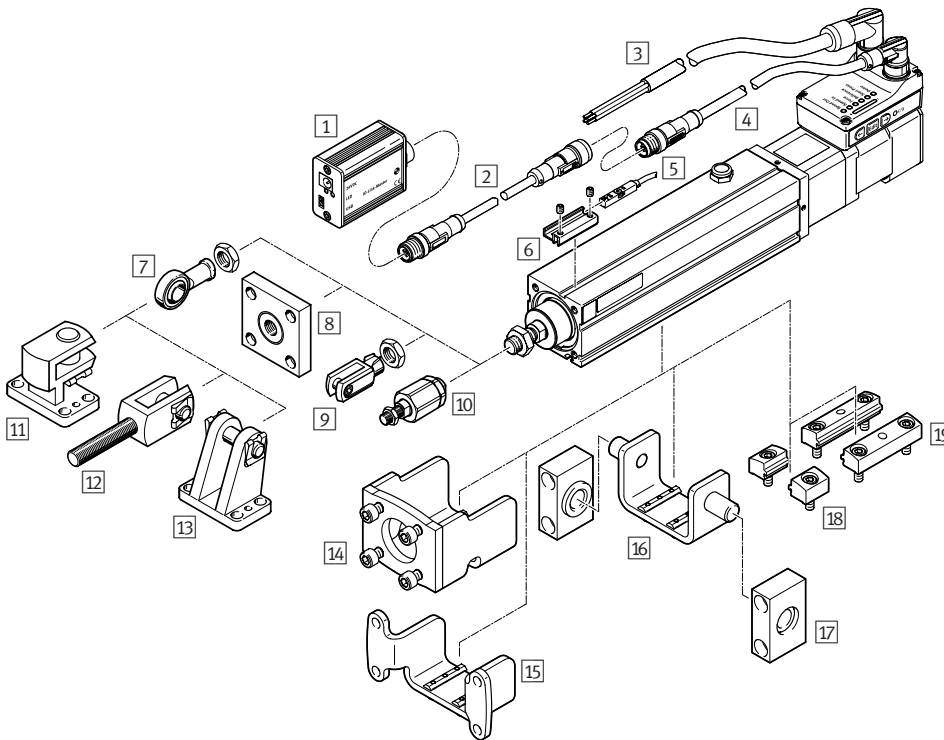

- 1 IO-Link® master USB CDSU-1 → 97
- 2 Adapter NEFC-M12G8 → 97
- 3 Supply cable NEBL-T12 → 98
- 4 Connecting cable NEBC-M12 → 98
- 5 Proximity switch¹⁾ SMT-8M-A → 223
- 6 Sensor bracket¹⁾ EAPM-L2 → [epcs](#)
- 7 Rod eye SGS → 98
- 8 Coupling piece KSG → 98
- 9 Rod clevis SG → 98
- 10 Self-aligning rod coupler FK → 98
- 11 Right-angle clevis foot LQG → 98
- 12 Rod clevis SGA → 98
- 13 Clevis foot LBG → 98
- 14 Adapter kit EAHA-P2 → 98

15 Flange mounting EAHH-P2 → 98

16 Swivel mounting EAHS-P2 → 98

17 Trunnion support LNZG → 98

19 Profile mounting EAHF-L2-P → [epcs](#)

18 Profile mounting → [epcs](#)

1) Proximity switches are optional and only required in order to sense any intermediate positions.

Accessories

1 IO-Link® master USB CDSU-1		
Cable length	Type	Part no.
For using the unit with IO-Link®		
0.3 m	CDSU-1	8091509

2 Adapter NEFC-M12G8			
Cable length	Connection, right	Type	Part no.
Connection, left: straight socket, M12x1, 8-pin			
0.3 m	Straight connector, M12x1, 5-pin	NEFC-M12G8-0.3-M12G5-LK	8080777

Electric cylinders and slides >

Electric cylinder units EPCS-BS

Accessories

02 Electric drives

3 Supply cable NEBL-T12

Cable length	Connection, right	Type	Part no.
Connection, left: angled socket, M12x1, 4-pin			
2 m	Cable, open end, 4-wire	NEBL-T12W4-E-2-N-LE4	8080778
5 m		NEBL-T12W4-E-5-N-LE4	8080779
10 m		NEBL-T12W4-E-10-N-LE4	8080780
15 m		NEBL-T12W4-E-15-N-LE4	8080781
Connection, left: straight socket, M12x1, 4-pin			
2 m	Cable, open end, 4-wire	NEBL-T12G4-E-2-N-LE4	8080790
5 m		NEBL-T12G4-E-5-N-LE4	8080791
10 m		NEBL-T12G4-E-10-N-LE4	8080792
15 m		NEBL-T12G4-E-15-N-LE4	8080793

4 Connecting cable NEBC-M12

Cable length	Connection, right	Type	Part no.
Connection, left: angled socket, M12x1, 8-pin			
2 m	Cable, open end, 8-wire	NEBC-M12W8-E-2-N-B-LE8	8094476
5 m		NEBC-M12W8-E-5-N-B-LE8	8094478
10 m		NEBC-M12W8-E-10-N-B-LE8	8094481
15 m		NEBC-M12W8-E-15-N-B-LE8	8094479
2 m	Straight connector, M12x1, 8-pin	NEBC-M12W8-E-2-N-M12G8	8080786
5 m		NEBC-M12W8-E-5-N-M12G8	8080787
10 m		NEBC-M12W8-E-10-N-M12G8	8080788
15 m		NEBC-M12W8-E-15-N-M12G8	8080789
Connection, left: straight socket, M12x1, 8-pin			
2 m	Cable, open end, 8-wire	NEBC-M12G8-E-2-N-B-LE8	8094480
5 m		NEBC-M12G8-E-5-N-B-LE8	8094477
10 m		NEBC-M12G8-E-10-N-B-LE8	8094482
15 m		NEBC-M12G8-E-15-N-B-LE8	8094475
2 m	Straight connector, M12x1, 8-pin	NEBC-M12G8-E-2-N-M12G8	8080782
5 m		NEBC-M12G8-E-5-N-M12G8	8080783
10 m		NEBC-M12G8-E-10-N-M12G8	8080784
15 m		NEBC-M12G8-E-15-N-M12G8	8080785

6 Sensor bracket EAPM-L2

For size	Type	Part no.
32, 45, 60	EAPM-L2-SH	4759852

7 Rod eye SGS

For size	Type	Part no.
32	SGS-M8	9255
45	SGS-M10x1,25	9261
60	SGS-M12x1,25	9262

8 Coupling piece KSG

For size	Type	Part no.
45	KSG-M10x1,25	32963
60	KSG-M12x1,25	32964

9 Rod clevis SG

For size	Type	Part no.
32	SG-M8	3111
45	SG-M10x1,25	6144
60	SG-M12x1,25	6145

10 Self-aligning rod coupler FK

For size	Type	Part no.
32	FK-M8	2062
45	FK-M10x1,25	6140
60	FK-M12x1,25	6141

11 Right-angle clevis foot LQG

For size	Type	Part no.
45	LQG-32	31768
60	LQG-40	31769

12 Rod clevis SGA

For size	Type	Part no.
45	SGA-M10x1,25	32954
60	SGA-M12x1,25	10767

13 Clevis foot LBG

For size	Type	Part no.
45	LBG-32	31761
60	LBG-40	31762

14 Adapter kit EAHA-P2

For size	Type	Part no.
32	EAHA-P2-32	5173020
45	EAHA-P2-45	5172353
60	EAHA-P2-60	5173082

15 Flange mounting EAHH-P2

For size	Type	Part no.
32	EAHH-P2-32	5126157
45	EAHH-P2-45	5126669
60	EAHH-P2-60	5127005

16 Swivel mounting EAHS-P2

For size	Type	Part no.
32	EAHS-P2-32	5125041
45	EAHS-P2-45	5125167
60	EAHS-P2-60	5125281

17 Trunnion support LNZG

For size	Type	Part no.
32	LNZG-16	1434912
45	LNZG-32	32959
60	LNZG-4 0/50	32960

18 Profile mounting EAHF-L2-P

For size	Type	Part no.
32	EAHF-L2-25-P	4835684
45, 60	EAHF-L2-45-P	4835728

19 Profile mounting EAHF-L2-P-S

For size	Type	Part no.
32	EAHF-L2-25-P-S	5183153
45, 60	EAHF-L2-45-P-S	5184133

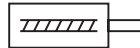

- With ball screw
- Degree of protection IP40
- Compact dimensions
- Extensive mounting accessories for various installation situations
- Suitable for simple applications in factory automation that in the past were mostly carried out using pneumatic solutions

Order code

001 002 003 004 005 006
EPCC - BS - - - ...P - A

Legend: Mandatory entry

001	Type
EPCC	Electric cylinder
002	Drive system
BS	Ball screw
003	Size
...	25, 32, 45, 60
004	Stroke [mm]
...	25, 50, 75, 100, 125, 150, 175, 200, 250

005	Spindle pitch [mm/rev]
...P	2, 3, 5, 6, 8, 10, 12
006	Position sensing
A	Via proximity switch

Configurable product

This product and all its product options can be ordered online via the configurator:

→ www.festo.com/catalogue/epcc

Ordering data

002 Ball screw – 006 Via proximity switch								
004 Stroke [mm]	003 Size – 005 Spindle pitch [mm/rev]							
	25 – 2P	25 – 6P	32 – 3P	32 – 8P	45 – 3P	45 – 10P	60 – 5P	60 – 12P
25	5428805	5428813	5428833	5428841	5428858	5428868	5428888	5428901
50	5428806	5428814	5428834	5428842	5428859	5428869	5428889	5428902
75	5428807	5428815	5428835	5428843	5428860	5428870	5428890	5428903
100	5428808	5428816	5428836	5428844	5428861	5428871	5428891	5428904
125	5428809	5428817	5428837	5428845	5428862	5428872	5428892	5428905
150	5428810	5428818	5428838	5428846	5428863	5428873	5428893	5428906
175	5428811	5428819	5428839	5428847	5428864	5428874	5428894	5428907
200	5428812	5428820	5428840	5428848	5428865	5428875	5428895	5428908
250							5428896	5428909

Electric cylinders and slides >
Electric cylinders EPCC, with spindle drive

Accessories

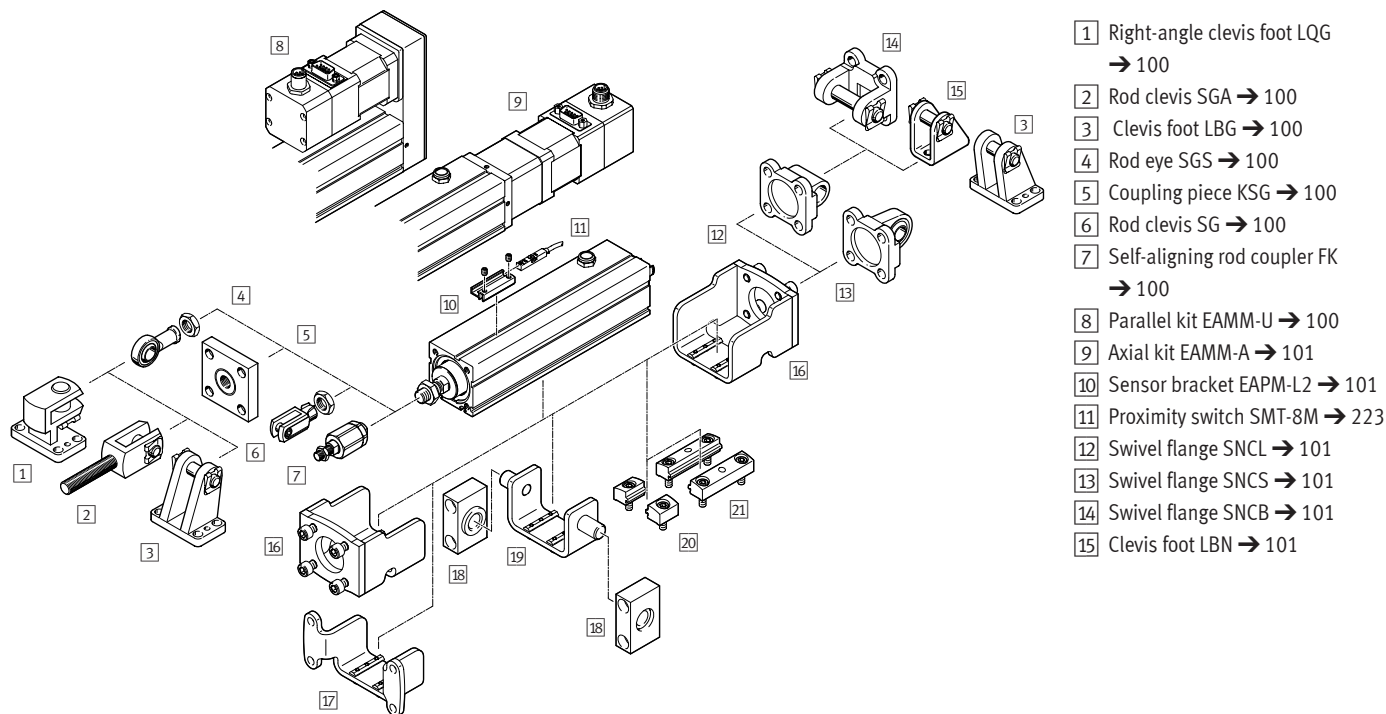

- 1 Right-angle clevis foot LQG → 100
- 2 Rod clevis SGA → 100
- 3 Clevis foot LBG → 100
- 4 Rod eye SGS → 100
- 5 Coupling piece KSG → 100
- 6 Rod clevis SG → 100
- 7 Self-aligning rod coupler FK → 100
- 8 Parallel kit EAMM-U → 100
- 9 Axial kit EAMM-A → 101
- 10 Sensor bracket EAPM-L2 → 101
- 11 Proximity switch SMT-8M → 223
- 12 Swivel flange SNCL → 101
- 13 Swivel flange SNCS → 101
- 14 Swivel flange SNCB → 101
- 15 Clevis foot LBN → 101

- 16 Adapter kit EAHA-P2 → 101
- 17 Flange mounting EAHH-P2 → 101
- 18 Trunnion support LNZG → 101
- 19 Swivel mounting EAHS-P2 → 101
- 20 Profile mounting EAHF-L2-P-S → 101
- 21 Profile mounting EAHF-L2-P → 101

1 Right-angle clevis foot LQG		
For size	Type	Part no.
45	LQG-32	31768
60	LQG-40	31769

2 Rod clevis SGA		
For size	Type	Part no.
45	SGA-M10x1,25	32954
60	SGA-M12x1,25	10767

3 Clevis foot LBG		
For size	Type	Part no.
45	LBG-32	31761
60	LBG-40	31762

4 Rod eye SGS		
For size	Type	Part no.
25	SGS-M6	9254
32	SGS-M8	9255
45	SGS-M10x1,25	9261
60	SGS-M12x1,25	9262

5 Coupling piece KSG		
For size	Type	Part no.
45	KSG-M10x1,25	32963
60	KSG-M12x1,25	32964

6 Rod clevis SG		
For size	Type	Part no.
25	SG-M6	3110
32	SG-M8	3111
45	SG-M10x1,25	6144
60	SG-M12x1,25	6145

7 Self-aligning rod coupler FK		
For size	Type	Part no.
25	FK-M6	2061
32	FK-M8	2062
45	FK-M10x1,25	6140
60	FK-M12x1,25	6141

8 Parallel kit EAMM-U			
For	With motor	Type	Part no.
In combination with stepper motor EMMS-ST			
25	EMMS-ST-28-...	EAMM-U-30-V20-28A-44	4767125
32	EMMS-ST-42-...	EAMM-U-45-V25-42A-63	4825645
45	EMMS-ST-42-...	EAMM-U-45-V32-42A-63	4280674
60	EMMS-ST-57-...	EAMM-U-65-T42-57A-87	4331535
In combination with servo motor EMME-AS			
32	EMME-AS-40-...	EAMM-U-45-V25-40P-63	4782056
45	EMME-AS-40-...	EAMM-U-45-V32-40P-63	4718297
60	EMME-AS-60-...	EAMM-U-65-T42-60P-87	4784301

Accessories

9 Axial kit EAMM-A			
For	With motor	Type	Part no.
In combination with stepper motor EMMS-ST			
25	EMMS-ST-28-...	EAMM-A-V20-28A	4505258
32	EMMS-ST-42-...	EAMM-A-V25-42A	4582608
45	EMMS-ST-42-...	EAMM-A-V32-42A	4281142
	EMMS-ST-57-...	EAMM-A-V32-57A	4597016
60	EMMS-ST-57-...	EAMM-A-T42-57A	4327034
	EMMS-ST-87-...	EAMM-A-T42-87A	4610008
In combination with servo motor EMME-AS			
32	EMME-AS-40-...	EAMM-A-V25-40P	4491059
45	EMME-AS-40-...	EAMM-A-V32-40P	4595742
	EMME-AS-60-...	EAMM-A-V32-60P	4608750
60	EMME-AS-60-...	EAMM-A-T42-60P	4133487
	EMME-AS-80-...	EAMM-A-T42-80P	4623788

10 Sensor bracket EAPM-L2			
For size	Type	Part no.	
25, 32, 45, 60	EAPM-L2-SH	4759852	

12 Swivel flange SNCL			
For	Type	Part no.	
25	SNCL-16	537791	
32	SNCL-20	537792	
45	SNCL-32	174404	
60	SNCL-40	174405	

13 Swivel flange SNCS			
For size	Type	Part no.	
45	SNCS-32	174397	
60	SNCS-40	174398	

14 Swivel flange SNCB			
For size	Type	Part no.	
45	SNCB-32	174390	
60	SNCB-40	174391	

15 Clevis foot LBN			
For size	Type	Part no.	
25	LBN-12/16	6058	
32	LBN-20/25	6059	
45	LBN-32	195860	
60	LBN-40	195861	

16 Adapter kit EAHA-P2			
For size	Type	Part no.	
25	EAHA-P2-25	5172843	
32	EAHA-P2-32	5173020	
45	EAHA-P2-45	5172353	
60	EAHA-P2-60	5173082	

17 Flange mounting EAHH-P2			
For size	Type	Part no.	
25	EAHH-P2-25	5127286	
32	EAHH-P2-32	5126157	
45	EAHH-P2-45	5126669	
60	EAHH-P2-60	5127005	

18 Trunnion support LNZG			
For size	Type	Part no.	
25, 32	LNZG-16	1434912	
45	LNZG-32	32959	
60	LNZG-4 0/50	32960	

19 Swivel mounting EAHS-P2			
For size	Type	Part no.	
25	EAHS-P2-25	5125383	
32	EAHS-P2-32	5125041	
45	EAHS-P2-45	5125167	
60	EAHS-P2-60	5125281	

20 Profile mounting EAHF-L2-P-S			
For size	Type	Part no.	
25, 32	EAHF-L2-25-P-S	5183153	
45, 60	EAHF-L2-45-P-S	5184133	

21 Profile mounting EAHF-L2-P			
For size	Type	Part no.	
25, 32	EAHF-L2-25-P	4835684	
45, 60	EAHF-L2-45-P	4835728	

Electric cylinders and slides >

Electric cylinders ESBF, with spindle drive

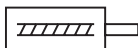

- Based on ISO 15552
- Available with ball screw (size 32 ... 100) and lead screw (size 32 ... 50)
- Three spindle pitches (ball screw) make it possible to select the optimal force/speed ratio
- Optional: high corrosion protection, degree of protection IP65, suitable to a limited extent for food zone, see www.festo.com/sp/esbf > "Certificates" tab
- High rigidity and precision (ball screw)
- Axial or parallel motor mounting

Order code – Basic design

001 002 003 004 005 006 007 008 009 010
 ESBF - BS - - - ...P - - - - -

Legend: Mandatory entry Optional entry

001	Type
ESBF	Electric cylinder
002	Drive system
BS	Ball screw
003	Size
...	32, 40, 50, 63
004	Stroke [mm]
...	100, 200, 300, 400
005	Spindle pitch [mm/rev]
...P	5, 10, 15, 16, 20, 25

006	Piston rod thread type
-	Male thread
007	Degree of protection for electrics
-	Standard
008	Corrosion protection
-	Standard
009	Additional features
-	None
010	Piston rod extension
-	None

Product options

80, 100 Size 30 ... 1500 mm Variable stroke	F Piston rod with female thread	F1 Additional feature: food-safe in accordance with supplementary material information, see www.festo.com/sp/esbf > "Certificates" tab	...E Piston rod extension 1 ... 200 mm
Spindle pitch mm/rev 2.5, 3, 4, 15, 32, 40	S1 Degree of protection for electrics IP65		
	R3 High corrosion protection		



Configurable product

This product and all its product options can be ordered online via the configurator:

→ www.festo.com/catalogue/esbf

Ordering data – Basic design

002 Ball screw – 006 Piston rod with male thread – 007 Standard degree of protection for electrical system – 008 Standard corrosion protection – 009 Without additional features – 010 Without piston rod extension

004 Stroke [mm]	003 Size – 005 Spindle pitch [mm/rev]										
	32 – 5	32 – 10	40 – 5	40 – 10	40 – 16	50 – 5	50 – 10	50 – 20	63 – 5	63 – 10	63 – 25
100	8022562	8022565	8022574	8022577	8022581	8022590	8022593	8022597	574093	574096	574100
200	2215384	8022566	2215385	8022578	8022582	2215386	8022594	8022598	1347390	574097	574101
300	8022563	8022567	8022575	8022579	8022583	8022591	8022595	8022599	574094	574098	574102
400	8022564	8022568	8022576	8022580	8022584	8022592	8022596	8022600	574095	574099	574103

Accessories

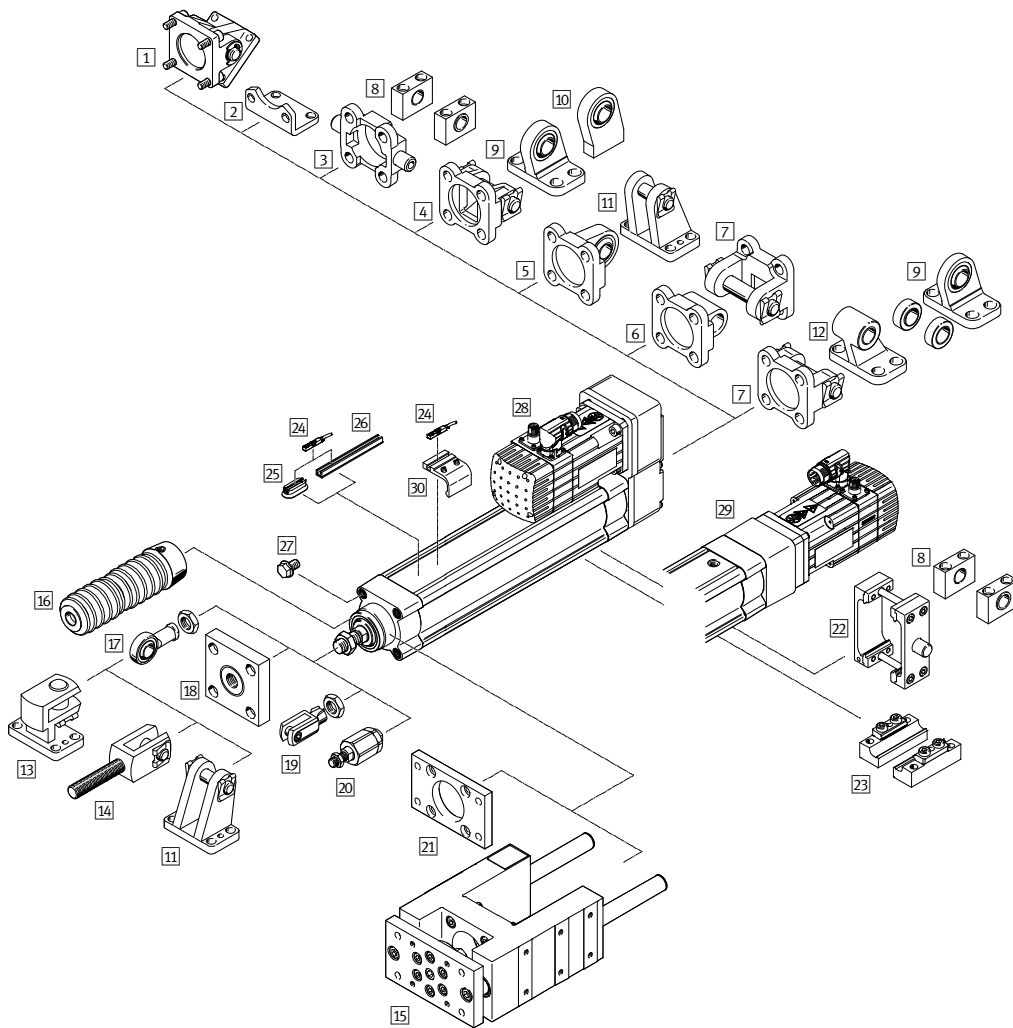

- 1 Swivel flange DAMS → 103
- 2 Foot mounting HNC → 103
- 3 Trunnion flange ZNCF → 103
- 4 Swivel flange SNC → 103
- 5 Swivel flange SNCS → 103
- 6 Swivel flange SNCL → 104
- 7 Swivel flange SNCB → 104
- 8 Trunnion support LNZZ → 104
- 9 Clevis foot LSN/LSNG → 104
- 10 Clevis foot LSNSG → 104
- 11 Clevis foot LBG → 104
- 12 Clevis foot LNG → 104
- 13 Right-angle clevis foot LQG → 104
- 14 Rod clevis SGA → 104
- 15 Guide unit EAGF-V2 → [esbf](#)
- 16 Bellows kit EADB → [esbf](#)
- 17 Rod eye SGS → 104
- 18 Coupling piece KSZ → 104
- 19 Rod clevis SG → 104
- 20 Self-aligning rod coupler FK → 104
- 21 Flange mounting EAHH → 104
- 22 Trunnion mounting kit DAMT → 104
- 23 Profile mounting EAHF-V2 → 104
- 24 Proximity switch SMT-8M → 223

- 25 Mounting kit CRSMB → 105
- 26 Sensor rail SAMH → 105

- 27 Plug screw DAMD-PS → 105
- 28 Parallel kit EAMM-U → 105

- 29 Axial kit EAMM-A → 105
- 30 Mounting kit SMB-8-FENG → 105

1 Swivel flange DAMS		
For size	Type	Part no.
40	DAMS-K-V1-40-V-R3	2787470
50	DAMS-K-V1-50-V-R3	2787651
63	DAMS-K-V1-63-V-R3	1555443

2 Foot mounting HNC		
For size	Type	Part no.
32	HNC-32	174369
40	HNC-40	174370
50	HNC-50	174371
63	HNC-63	174372

3 Trunnion flange ZNCF		
For size	Type	Part no.
32	ZNCF-32	174411
40	ZNCF-40	174412
50	ZNCF-50	174413
63	ZNCF-63	174414

4 Swivel flange SNC		
For size	Type	Part no.
32	SNC-32	174383
40	SNC-40	174384
50	SNC-50	174385
63	SNC-63	174386

5 Swivel flange SNCS		
For size	Type	Part no.
32	SNCS-32	174397
40	SNCS-40	174398
50	SNCS-50	174399
63	SNCS-63	174400

Electric cylinders and slides >

Electric cylinders ESBF, with spindle drive

Accessories

6 Swivel flange SNCL

For size	Type	Part no.
32	SNCL-32	174404
40	SNCL-40	174405
50	SNCL-50	174406
63	SNCL-63	174407

7 Swivel flange SNCB

For size	Type	Part no.
32	SNCB-32	174390
40	SNCB-40	174391
50	SNCB-50	174392
63	SNCB-63	174393

8 Trunnion support LNZZ

For size	Type	Part no.
32	LNZZ-32	32959
40, 50	LNZZ-40/50	32960
63	LNZZ-63/80	32961

9 Clevis foot LSN

For size	Type	Part no.
32	LSN-32	5561
40	LSN-40	5562
50	LSN-50	5563
63	LSN-63	5564

9 Clevis foot LSNG

For size	Type	Part no.
32	LSNG-32	31740
40	LSNG-40	31741
50	LSNG-50	31742
63	LSNG-63	31743

10 Clevis foot LSNSG

For size	Type	Part no.
32	LSNSG-32	31747
40	LSNSG-40	31748
50	LSNSG-50	31749
63	LSNSG-63	31750

11 Clevis foot LBG

For size	Type	Part no.
32	LBG-32	31761
40	LBG-40	31762
50	LBG-50	31763
63	LBG-63	31764

12 Clevis foot LNG

For size	Type	Part no.
32	LNG-32	33890
40	LNG-40	33891
50	LNG-50	33892
63	LNG-63	33893

13 Right-angle clevis foot LQG

For size	Type	Part no.
32	LQG-32	31768
40	LQG-40	31769
50	LQG-50	31770
63	LQG-63	31771

14 Rod clevis SGA

For size	Type	Part no.
32	SGA-M10x1,25	32954
40	SGA-M12x1,25	10767
50, 63	SGA-M16x1,5	10768

17 Rod eye SGS

For size	Type	Part no.
32	SGS-M10x1,25	9261
40	SGS-M12x1,25	9262
50, 63	SGS-M16x1,5	9263

18 Coupling piece KSZ

For size	Type	Part no.
32	KSZ-M10x1,25	36125
40	KSZ-M12x1,25	36126
50, 63	KSZ-M16x1,5	36127

19 Rod clevis SG

For size	Type	Part no.
32	SG-M10x1,25	6144
40	SG-M12x1,25	6145
50, 63	SG-M16x1,5	6146

20 Self-aligning rod coupler FK

For size	Type	Part no.
32	FK-M10x1,25	6140
40	FK-M12x1,25	6141
50, 63	FK-M16x1,5	6142

21 Flange mounting EAHH

For size	Type	Part no.
32	EAHH-V2-32-R1	2827587
40	EAHH-V2-40-R1	2827588
50	EAHH-V2-50-R1	2827589
63	EAHH-V2-63-R1	1502305

22 Trunnion mounting kit DAMT

For size	Type	Part no.
32	DAMT-V1-32-A	2213233
40	DAMT-V1-40-A	2214899
50	DAMT-V1-50-A	2214909
63	DAMT-V1-63-A	2214971

23 Profile mounting EAHF-V2

For size	Type	Part no.
32, 40	EAHF-V2-32/40-P	2838839
50, 63	EAHF-V2-50/63-P	1547781

Accessories

25 Mounting kit CRSMB

For size	Type	Part no.
32, 40, 50, 63	CRSMB-8-32/100	525565

26 Sensor rail SAMH

For size	Length	Type	Part no.
32, 40, 50, 63	50 mm	SAMH-N8-SR-50	1600093
32, 40, 50, 63	100 mm	SAMH-N8-SR-100	1600118

27 Plug screw DAMD

For size	Type	Part no.
32, 40	DAMD-PS-M6-12-R1	1355016
50, 63	DAMD-PS-M8-16-R1	650121

28 Parallel kit EAMM-U

For	With motor	Type	Part no.
In combination with stepper motor			
32	EMMS-ST-42-...	EAMM-U-50-D32-42A-78	1201607
	EMMS-ST-57-...	EAMM-U-60-D32-57A-91	1210419
40	EMMS-ST-57-...	EAMM-U-60-D40-57A-91	1210442
	EMMS-ST-87-...	EAMM-U-86-D40-87A-102	1215802
50	EMMS-ST-87-...	EAMM-U-86-D50-87A-102	2802708
63	EMMS-ST-87-...	EAMM-U-86-D60-87A-102	1215784
In combination with servo motor			
32	EMME-AS-40-...	EAMM-U-50-D32-40P-78	2153283
	EMMT-AS-60-...	EAMM-U-70-D32-60P-96	2619586
	EMME-AS-60-...		
40	EMMT-AS-60-...	EAMM-U-70-D40-60P-96	2617488
	EMME-AS-60-...		
	EMME-AS-80-...	EAMM-U-86-D40-80P-102	2802441
50	EMME-AS-100-...	EAMM-U-110-D50-100A-120	2799424
	EMMS-AS-100-...		
	EMME-AS-80-...	EAMM-U-86-D50-80P-102	2803053
63	EMME-AS-100-...	EAMM-U-110-D60-100A-120	1202436
	EMMS-AS-100-...		
	EMME-AS-80-...	EAMM-U-86-D60-80P-102	2155875
120	EMME-AS-100-...	EAMM-U-110-S62-100A-207	1217381
	EMMS-AS-100-...		

29 Axial kit EAMM-A

For	With motor/gear unit ¹⁾	Type	Part no.
In combination with stepper motor			
32	EMMS-ST-42-...	EAMM-A-D32-42A	543148
	EMMS-ST-57-...	EAMM-A-D32-57A	550980
40	EMMS-ST-57-...	EAMM-A-D40-57A	543154
	EMMS-ST-87-...	EAMM-A-D40-87A	550982
50	EMMS-ST-87-...	EAMM-A-D50-87A	2733781
63	EMMS-ST-87-...	EAMM-A-D60-87A	543162
In combination with stepper motor and gear unit			
40	EMMS-ST-42-...	EAMM-A-D40-40G	560282
	EMGA-40-P-G...-SST-42		
63	EMMS-ST-57-...	EAMM-A-D60-60G	560283
	EMGA-60-P-G...-SST-57		
In combination with servo motor			
32	EMME-AS-40-...	EAMM-A-D32-40P	1976465
	EMMT-AS-60-...	EAMM-A-D32-60P	1956054
	EMME-AS-60-...		
40	EMMT-AS-60-...	EAMM-A-D40-60P	1977000
	EMME-AS-60-...		
50	EMME-AS-100-...	EAMM-A-D50-100A	2733784
	EMMS-AS-100-...		
	EMME-AS-80-...	EAMM-A-D50-80P	2733785
63	EMME-AS-100-...	EAMM-A-D60-100A	550983
	EMMS-AS-100-...		
	EMME-AS-80-...	EAMM-A-D60-80P	1977073
In combination with servo motor and gear unit			
40	EMME-AS-40-...	EAMM-A-D40-40G	560282
	EMGA-40-P-G...-EAS-40		
	EMMS-AS-40-...		
63	EMGA-40-P-G...-SAS-40		
	EMMS-AS-55-...	EAMM-A-D60-60G	560283
	EMGA-60-P-G...-SAS-55		
	EMMS-AS-70-...		
	EMGA-60-P-G...-SAS-70		
In combination with servo motor and right-angle gear unit			
40	EMME-AS-40-...	EAMM-A-D40-40G	560282
	EMGA-40-A-G...-40P		

1) The input torque must not exceed the max. permissible transferable torque of the axial kit.

30 Mounting kit SMB-8-FENG

For size	Type	Part no.
32, 40	SMB-8-FENG-32/40	175705
50, 63	SMB-8-FENG-50/63	175706

Electric cylinders and slides >

Mini slides EGSC-BS-KF

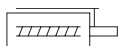

- The toothed belt and spindle axes ELGC together with the mini slides EGSC form a scalable modular system for compact automation
- Precision guide and ball screw
- Compact dimensions
- Flexible motor mounting

Order code

001 002 003 004 005 006
 EGSC - BS - KF - [] - [] - ...P

Legend: Mandatory entry

001	Type
EGSC	Mini slide
002	Drive system
BS	Ball screw
003	Guide
KF	Recirculating ball bearing guide
004	Size
...	25, 32, 45, 60

005	Stroke [mm]
...	25, 50, 75, 100, 125, 150, 200
006	Spindle pitch [mm/rev]
...P	6, 8, 10, 12

Order

002 Ball screw – 003 Recirculating ball bearing guide				
005 Stroke [mm] 004 Size – 006 Spindle pitch				
	25 – 6 mm/rev	32 – 8 mm/rev	45 – 10 mm/rev	60 – 12 mm/rev
25	8048310	8048306	8048300	
50	8048311	8048307	8048301	8048362
75	8061280	8048308	8048302	8048363
100		4356032	4022926	4356469
125			8048303	8048364
150	4454365	8061281	8048304	8048365
200		8061282		8048366

Accessories

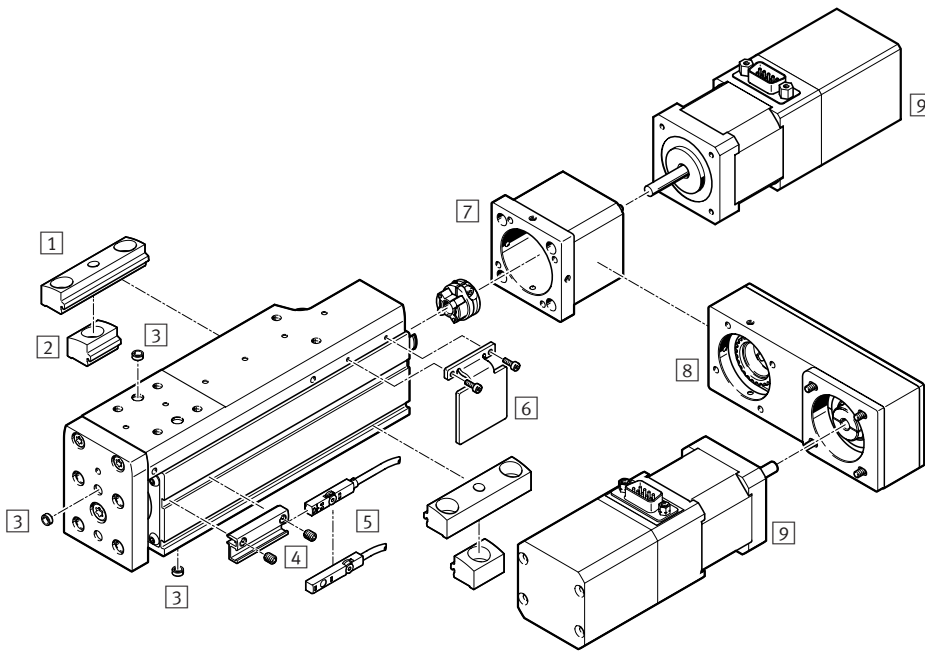

- 1 Profile mounting EAHF-L2-...-P → 107
- 2 Profile mounting EAHF-L2-...-P-S → 107
- 3 Centring pin/sleeve ZBS, ZHB → [egsc-bs](#)
- 4 Sensor bracket EAPM-L2 → 107
- 5 Proximity switch SIES-8M → 107
Proximity switch SMT-8M → 223
- 6 Switch lug EAPM-...-SLS → 107
- 7 Axial kit EAMM-A → 107
- 8 Parallel kit EAMM-U → 107
- 9 Motors EMMS-ST → 121
EMME-AS → [elgc-tb](#)

1 Profile mounting EAHF-L2-...-P

For size	Type	Part no.
For mounting the axis on the side of the profile		
25, 32	EAHF-L2-25-P	4835684
45, 60	EAHF-L2-45-P	4835728

2 Profile mounting EAHF-L2-...-P-S

For size	Type	Part no.
For mounting the axis on the side of the profile		
25, 32	EAHF-L2-25-P-S	5183153
45, 60	EAHF-L2-45-P-S	5184133

4 Sensor bracket EAPM-L2-SH

For size	Type	Part no.
25, 32, 45, 60	EAPM-L2-SH	4759852

5 Proximity switch for T-slot, inductive SIES-8M

Description		Type	Part no.
N/O contact	PNP, cable, 7.5 m	SIES-8M-PS-24V-K-7,5-OE	551386
	PNP, plug, 0.3 m	SIES-8M-PS-24V-K-0,3-M8D	551387
	NPN, cable, 7.5 m	SIES-8M-NS-24V-K-7,5-OE	551396
	NPN, plug, 0.3 m	SIES-8M-NS-24V-K-0,3-M8D	551397
N/C contact	PNP, cable, 7.5 m	SIES-8M-PO-24V-K-7,5-OE	551391
	PNP, plug, 0.3 m	SIES-8M-PO-24V-K-0,3-M8D	551392
	NPN, cable, 7.5 m	SIES-8M-NO-24V-K-7,5-OE	551401
	NPN, plug, 0.3 m	SIES-8M-NO-24V-K-0,3-M8D	551402

6 Switch lug EAPM-L2-SLS

For size	Type	Part no.
For sensing using inductive proximity switches SIES-8M		
25	EAPM-E19-25-SLS	8067258
32	EAPM-L2-32-SLS	8067259
45	EAPM-L2-45-SLS	8067260
60	EAPM-L2-60-SLS	8067261

7 Axial kit EAMM-A

For	With motor	Type	Part no.
In combination with stepper motor EMMS-ST			
25	EMMS-ST-28-...	EAMM-A-V20-28A	4505258
32	EMMS-ST-42-...	EAMM-A-V25-42A	4582608
45	EMMS-ST-42-...	EAMM-A-V32-42A	4281142
	EMMS-ST-57-...	EAMM-A-V32-57A	4597016
60	EMMS-ST-57-...	EAMM-A-T42-57A	4327034
	EMMS-ST-87-...	EAMM-A-T42-87A	4610008
In combination with servo motor EMME-AS			
32	EMME-AS-40-...	EAMM-A-V25-40P	4491059
45	EMME-AS-40-...	EAMM-A-V32-40P	4595742
	EMME-AS-60-...	EAMM-A-V32-60P	4608750
60	EMME-AS-60-...	EAMM-A-T42-60P	4133487
	EMME-AS-80-...	EAMM-A-T42-80P	4623788

8 Parallel kit EAMM-U

For	With motor	Type	Part no.
In combination with stepper motor EMMS-ST			
25	EMMS-ST-28-...	EAMM-U-30-V20-28A-44	4767125
32	EMMS-ST-42-...	EAMM-U-45-V25-42A-63	4825645
45	EMMS-ST-42-...	EAMM-U-45-V32-42A-63	4280674
60	EMMS-ST-57-...	EAMM-U-65-T42-57A-87	4331535
In combination with servo motor EMME-AS			
32	EMME-AS-40-...	EAMM-U-45-V25-40P-63	4782056
45	EMME-AS-40-...	EAMM-U-45-V32-40P-63	4718297
60	EMME-AS-55-...	EAMM-U-65-T42-55A-87	8092868
	EMME-AS-60-...	EAMM-U-65-T42-60P-87	4784301

Electric cylinders and slides >

Mini slide units EGSS-BS-KF

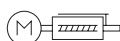

- Without external servo drive: all the necessary electronic components are combined in the integrated drive
- Simplified commissioning: all parameters can be manually set directly on the drive
- Very high-quality ball screw with low internal friction
- Rigid, high load-bearing and precise linear guide for absorbing lateral forces and increased anti-twist protection

Order code – Basic design

001 002 003 004 005 006 007 008 009 010 011 012 013 014
 EGSS - BS - KF - [] - [] - ...P - ST - M - H1 - PLK - AA - [] - [] - []

001	Type
EGSS	Electric slide drive
002	Drive system
BS	Ball screw drive
003	Guide
KF	Recirculating ball bearing guide
004	Size
...	32, 45, 60
005	Stroke [mm]
...	25, 50, 75, 100, 125, 150, 200
006	Spindle pitch [mm/rev]
...P	8, 10, 12
007	Motor type
ST	Stepper motor
008	Controller
M	Integrated

009	Control panel
H1	Integrated
010	Bus protocol/activation
PLK	PNP and IO-Link®
011	End-position sensing
AA	With integrated end-position sensing
012	Cable outlet direction
-	Standard
013	Electrical accessories
-	None
014	Operating instructions
-	With operating instructions

Legend: Mandatory entry Optional entry

Product options

Bus protocol/activation
 NLK NPN and IO-Link®

Cable outlet direction
 D Underneath
 L Left
 R Right

Electrical accessories
 L1 Adapter for operation as IO-Link® device

Operating instructions
 DN Without operating instructions

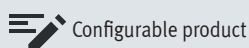

This product and all its product options can be ordered online via the configurator:

→ www.festo.com/catalogue/...

Enter the part number or the type.

Part no.	Type
8083800	EGSS-BS-KF-32-...
8083813	EGSS-BS-KF-45-...
8083713	EGSS-BS-KF-60-...

Ordering data – Basic design

002 Ball screw – 003 Recirculating ball bearing guide – 007 Stepper motor – 008 Integrated controller – 009 Integrated control panel – 010 Bus protocol/activation via PNP and IO-Link® – 011 With integrated end-position sensing – 012 Standard cable outlet – 013 Without electrical accessories – 014 With operating instructions

005 Stroke [mm]	004 Size – 006 Spindle pitch		
	32 – 8 mm/rev	45 – 10 mm/rev	60 – 12 mm/rev
25	8083801	8083814	
50	8083802	8083815	8083716
75	8083803	8083816	8083717
100	8083804	8083817	8083718
125		8083818	8083719
150		8083819	8083720
200			8083721

Accessories

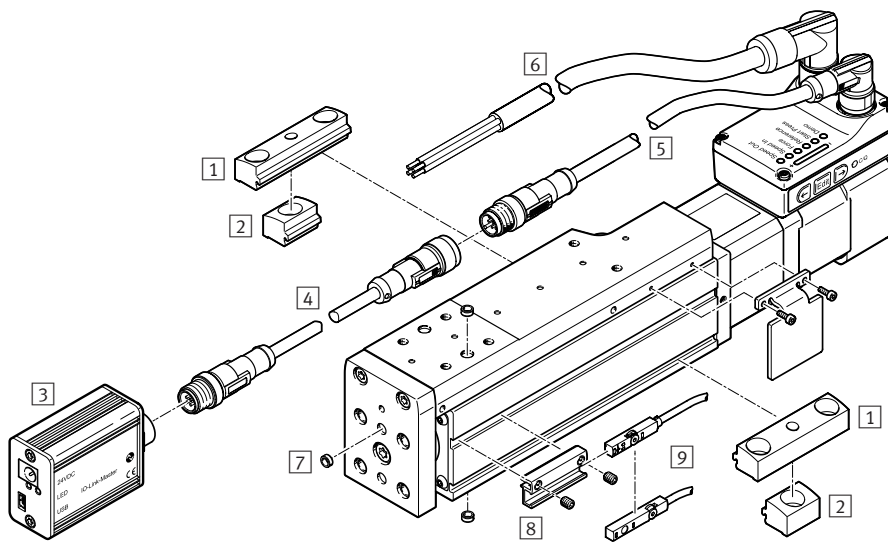

- 1 Profile mounting EAHF-L2-...-P → 109
- 2 Profile mounting EAHF-L2-...-P-S → 109
- 3 IO-Link® master USB CDSU-1 → 93
- 4 Adapter NEFC-M12G8 → 109
- 5 Connecting cable NEBC-M12 → 93
- 6 Supply cable NEBL-T12 → 93
- 7 Centring pin/sleeve ZBS, ZBH → egss
- 8 Sensor bracket EAPM-L2
- 9 Proximity switch SIES-8M → 93
Proximity switch SMT-8M → 223
- 10 Switch lug EAPM-...-SLS → 93

1 Profile mounting EAHF-L2-...-P-S

For size	Type	Part no.
For mounting the axis on the side of the profile		
32	EAHF-L2-25-P-S	5183153
45, 60	EAHF-L2-45-P-S	5184133

2 Profile mounting EAHF-L2-...-P

For size	Type	Part no.
For mounting the axis on the side of the profile		
32	EAHF-L2-25-P	4835684
45, 60	EAHF-L2-45-P	4835728

4 Adapter NEFC-M12G8

Cable length	Connection, right	Type	Part no.
Connection, left: straight socket, M12x1, 8-pin			
0.3 m	Straight plug, M12x1, 5-pin	NEFC-M12G8-0.3-M12G5-LK	8080777

6 Sensor bracket EAPM-L2-SH

For size	Type	Part no.
32, 45, 60	EAPM-L2-SH	4759852

Electric semi-rotary drives >
Rotary drive units ERMS



- Without external servo drive: all the necessary electronic components are combined in the integrated drive
- Two control options integrated as standard: digital I/O and IO-Link®
- Complete solution for simple movements between mechanical end positions
- Simplified commissioning: all parameters can be manually set directly on the drive
- No special expertise required for commissioning

Order code – Basic design

001 002 003 004 005 006 007 008 009 010 011
ERMS - [] - [] - ST - M - H1 - PLK - AA - [] - [] - []

001	Type
ERMS	Rotary drive
002	Size
...	25, 32
003	Nominal swivel angle [°]
...	90, 180
004	Motor type
ST	Stepper motor
005	Controller
M	Integrated
006	Control panel
H1	Integrated

007	Bus protocol/activation
PLK	PNP and IO-Link®
008	End-position detection
AA	With integrated end-position sensing
009	Cable outlet direction
-	Standard
010	Electrical accessories
-	None
011	Operating instructions
-	With operating instructions

Legend: Mandatory entry Optional entry

Product options

Bus protocol/activation	Cable outlet direction	Electrical accessories	Operating instructions
NLK NPN and IO-Link®	L Left R Right	L1 Adapter for operation as IO-Link® device	DN Without operating instructions

Configurable product

This product and all its product options can be ordered online via the configurator:
→ www.festo.com/catalogue/...
Enter the part number or the type.

Part no.	Type
8087808	ERMS-25-...
8087809	ERMS-32-...

Ordering – Basic design

004 Stepper motor – 005 Integrated controller – 006 Integrated control panel – 007 Bus protocol/activation via PNP and IO-Link® – 008 With integrated end-position sensing – 009 Standard cable outlet – 010 Without electrical accessories – 011 With operating instructions				
003 Nominal swivel angle [°]	002 Size			
	25	32		
	Type	Part no.	Type	Part no.
90	ERMS-25-90-ST-M-H1-PLK-AA	8087819	ERMS-32-90-ST-M-H1-PLK-AA	8087821
180	ERMS-25-180-ST-M-H1-PLK-AA	8087820	ERMS-32-180-ST-M-H1-PLK-AA	8087822

Accessories

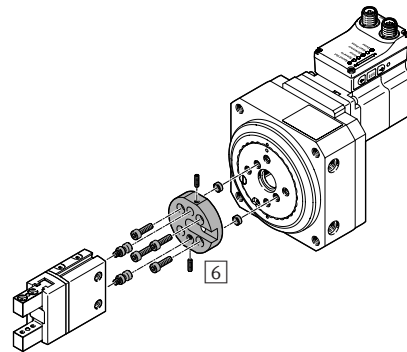
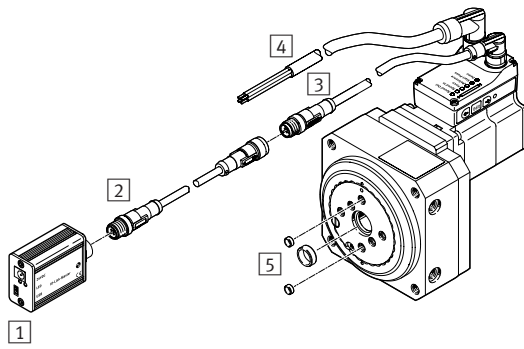

- 1 IO-Link® master USB CDSU-1 → 111
- 2 Adapter NEFC-M12G8 → 111
- 3 Connecting cable NEBC-M12 → 111
- 4 Supply cable NEBL-T12 → 111
- 5 Centring sleeve ZBH → 111
Central mounting SLZZ → 111
- 6 Adapter kit DHAA → [dhaa](#)

1 IO-Link® master USB CDSU-1		
Cable length	Type	Part no.
0.3 m	CDSU-1	8091509

2 Adapter NEFC-M12G8		
Cable length	Type	Part no.
0.3 m	NEFC-M12G8-0.3-M12G5-LK	8080777

3 Connecting cable NEBC-M12			
Cable length	Connection, right	Type	Part no.
Connection, left: angled socket, M12x1, 8-pin			
2 m	Cable, open end, 8-wire	NEBC-M12W8-E-2-N-B-LE8	8094476
5 m		NEBC-M12W8-E-5-N-B-LE8	8094478
10 m		NEBC-M12W8-E-10-N-B-LE8	8094481
15 m		NEBC-M12W8-E-15-N-B-LE8	8094479
2 m	Straight plug, M12x1, 8-pin	NEBC-M12W8-E-2-N-M12G8	8080786
5 m		NEBC-M12W8-E-5-N-M12G8	8080787
10 m		NEBC-M12W8-E-10-N-M12G8	8080788
15 m		NEBC-M12W8-E-15-N-M12G8	8080789
Connection, left: straight socket, M12x1, 8-pin			
2 m	Cable, open end, 8-wire	NEBC-M12G8-E-2-N-B-LE8	8094480
5 m		NEBC-M12G8-E-5-N-B-LE8	8094477
10 m		NEBC-M12G8-E-10-N-B-LE8	8094482
15 m		NEBC-M12G8-E-15-N-B-LE8	8094475
2 m	Straight plug, M12x1, 8-pin	NEBC-M12G8-E-2-N-M12G8	8080782
5 m		NEBC-M12G8-E-5-N-M12G8	8080783
10 m		NEBC-M12G8-E-10-N-M12G8	8080784
15 m		NEBC-M12G8-E-15-N-M12G8	8080785

4 Supply cable NEBL-T12			
Cable length	Connection, right	Type	Part no.
Connection, left: angled socket, M12x1, 4-pin			
2 m	Cable, open end, 4-wire	NEBL-T12W4-E-2-N-LE4	8080778
5 m		NEBL-T12W4-E-5-N-LE4	8080779
10 m		NEBL-T12W4-E-10-N-LE4	8080780
15 m		NEBL-T12W4-E-15-N-LE4	8080781
Connection, left: straight socket, M12x1, 4-pin			
2 m	Cable, open end, 4-wire	NEBL-T12G4-E-2-N-LE4	8080790
5 m		NEBL-T12G4-E-5-N-LE4	8080791
10 m		NEBL-T12G4-E-10-N-LE4	8080792
15 m		NEBL-T12G4-E-15-N-LE4	8080793

5 Centring sleeve ZBH ¹⁾ , central mounting SLZZ ²⁾		
For size	Type	Part no.
For centring the drive in the case of side mounting		
25	ZBH-9	150927
32	ZBH-12	189653
For centring attachments on the rotating plate		
25, 32	ZBH-7	186717
For centring attachments in the middle of the rotating plate		
25	ZBH-15	191409
32	SLZZ-25/16	150901

1) Packaging unit 10 pieces.
2) Packaging unit 1 piece.

03

Motors and servo drives

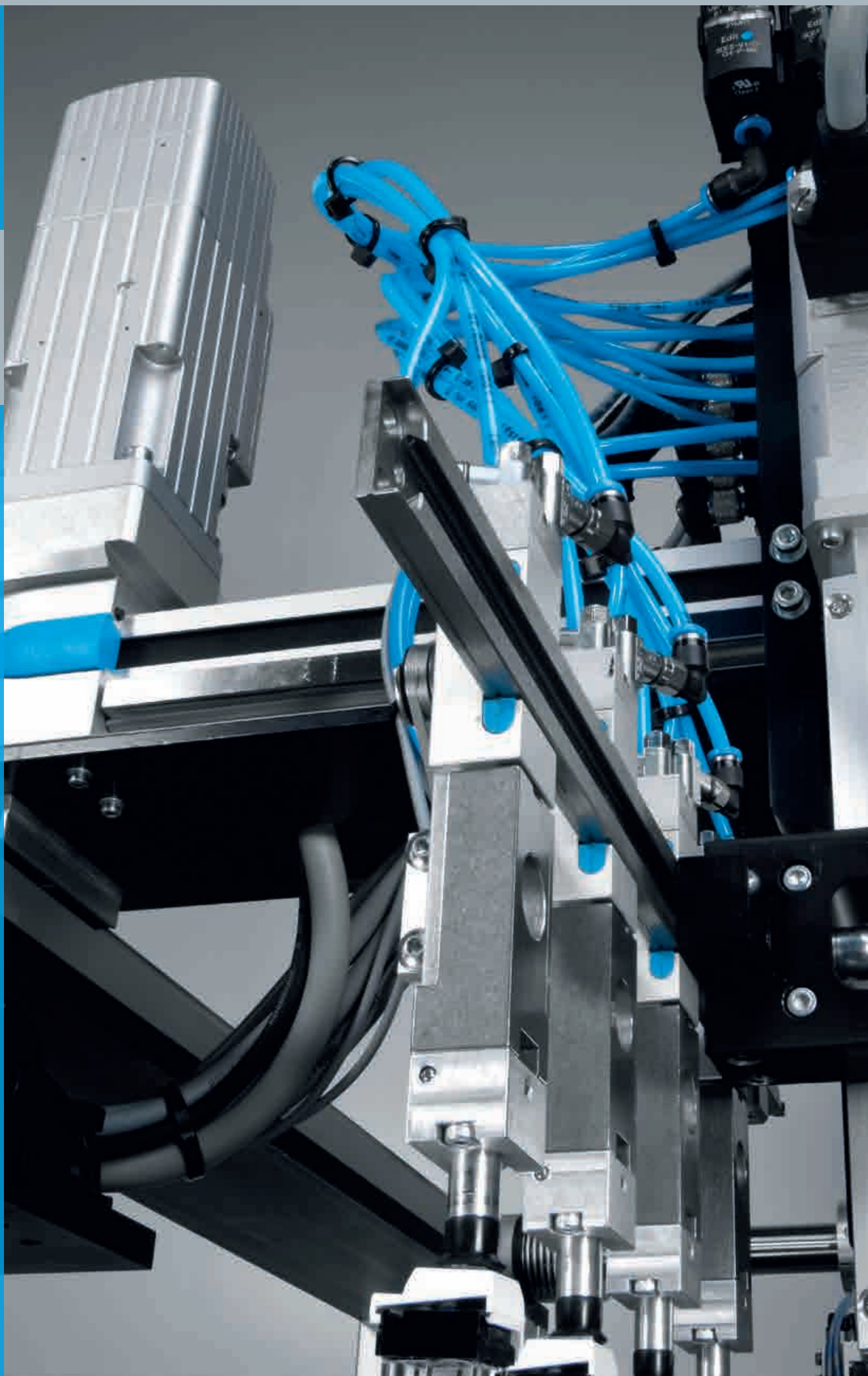

Highlights



Servo motors

EMMT-AS

- + Simple connection technology (OCP: one cable plug)
- + Choice of absolute measurement system: single turn or multi-turn, battery free

→ 118

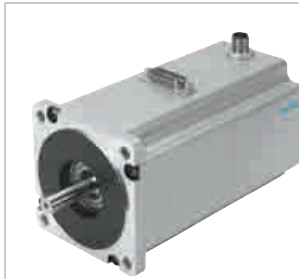

Stepper motors

EMMS-ST

- + Small increments and high driving torques thanks to 2-phase hybrid technology
- + Optimised connection technology

→ 121



Motor controllers

CMMS-ST

- + For actuating stepper motors EMMS-ST and drives ELGR, ERMO
- + Easy and convenient commissioning

→ 124



Contents

Product overview	114
Servo motors EMMT-AS	118
Stepper motors EMMS-ST	121
Servo drive CMMT-ST, for extra-low voltage	123
Motor controllers CMMS-ST	124



Product overview

Software-Tools

03 Motors and servo drives

<p>Festo Configuration Tool (FCT)</p>		<p>FCT is a configuration and parameterisation software program that supports all Festo devices, in particular motor controllers.</p> <p>It is extremely flexible, provides full support for the device properties and is simple and intuitive to operate. The user is guided step-by-step through the commissioning process while each individual step is checked.</p> <p>The parameterisation software can be found on the website under Support > Support Portal > enter search term > select "Software" tab.</p>
<p>PositioningDrives: for selecting and sizing electro-mechanical linear drives, motors, and gear units</p>		<p>Which electromechanical linear drive, which motor and which gear unit best meets your needs?</p> <p>Enter the data for your application, such as position values, effective loads and mounting position, and the software will suggest several solutions.</p> <p>This tool can be found</p> <ul style="list-style-type: none"> in the electronic catalogue by clicking on the blue button "Engineering".



Servo motors

	 <p>Servo motors EMMT-AS</p>	 <p>Servo motors EMME-AS</p>
Nominal torque	0.6 ... 7.2 Nm	0.12 ... 6.4 Nm
Nominal rotational speed	2700 ... 3000 1/min	3000 ... 9000 1/min
Nominal motor power	190 ... 2030 W	110 ... 2000 W
Peak torque	1.6 ... 30.5 Nm	0.7 ... 30 Nm
Maximum speed	3770 ... 12500 1/min	3910 ... 10000 1/min
Description	<ul style="list-style-type: none"> For demanding tasks Brushless, permanently excited synchronous servo motor Digital absolute displacement encoder, single-turn or multi-turn Extremely low cogging torque – supports high synchronisation even at low rotational speeds Simple connection technology (OCP: one cable plug) – one connecting cable for supply and encoder Available with holding brake 	<ul style="list-style-type: none"> Brushless, permanently excited synchronous servo motor Digital absolute displacement encoder, single-turn or multi-turn Reliable, dynamic, precise Optimised connection technology Over 40 types in stock Available with holding brake Optional: multi-turn encoder with SIL2
→ Page/online	118	emme

Stepper motors

	 <p>Stepper motors EMMS-ST</p>
Nominal motor current	1.4 ... 9.5 A
Maximum speed	430 ... 6000 1/min
Motor holding torque	0.09 ... 9.3 Nm
Description	<ul style="list-style-type: none"> • Small increments and high driving torques thanks to 2-phase hybrid technology • Optimised connection technology • 28 stock types • With incremental encoder for closed-loop operation • Available with holding brake
→ Page/online	121

Gear units

	 <p>Gear units EMGA-P-EAS</p>	 <p>Gear units EMGA-P-SST</p>
Gear ratio	12:1, 20:1, 3:1, 5:1, 8:1	12:1, 3:1, 5:1, 8:1
Continuous output torque	6 ... 120 Nm	6 ... 120 Nm
Max. drive speed	7000 ... 18000 1/min	7000 ... 18000 1/min
Torsional rigidity	0.85 ... 10.4 Nm/arcmin	0.8 ... 10.4 Nm/arcmin
Torsional backlash	0.12 ... 0.31°	0.12 ... 0.31°
Mass moment of inertia, gear unit	0.015 ... 0.77 kgcm ²	0.015 ... 0.77 kgcm ²
Max. efficiency	96%, 97%, 98%	96%, 97%, 98%
Description	<ul style="list-style-type: none"> • Planetary gear unit for servo motors EMME-AS, EMMS-AS, EMMT-AS • Eco AC synchronous interface • Life-time lubrication • Degree of protection IP54 	<ul style="list-style-type: none"> • Planetary gear unit for stepper motors EMMS-ST • Life-time lubrication • Degree of protection IP54
→ Page/online	120	122

Product overview

Software-Tools

Festo Automation Suite commissioning software



Quickly and reliably to a ready-to-use drive system – the Festo Automation Suite combines the parameterisation, programming and maintenance of Festo components in one program and enables the entire drive package, from the mechanical system to the controller, to be commissioned. Perfect for making industrial automation simple, efficient and seamless.

Servo drive plug-in CMMT-AS



- An operational drive system in just 5 steps – parameterisation is almost fully automatic with the commissioning wizard
- Advanced editing with the expert view: full access to all device parameters
- Conveniently install the plug-in using the software

This tool can be found

- on our website at www.festo.com/AutomationSuite



Electric servo drives >

Servo drives

	 Servo drives CMMT-AS	 Motor controllers CMMP-AS-M0, CMMP-AS-M3
Nominal current		2 ... 13 A
Nominal operating voltage AC	230 ... 400 V	230 ... 400 V
Nominal operating voltage phases	1-phase, 3-phase	1-phase, 3-phase
Nominal power of controller	350 ... 6000 VA	500 ... 9000 VA
Fieldbus coupling	EtherCAT, EtherNet/IP, PROFINET	CANopen, DeviceNet, EtherCAT, EtherNet/IP, Modbus/TCP, PROFINET, PROFIBUS DP
Description	<ul style="list-style-type: none"> • Can be used universally • The latest generation of servo drive systems with optimised prices and sizes • One of the most compact servo drives on the market • Configure standard safety functions without software • Auto-tuning supports easy commissioning and automatically optimises the control behaviour of rotary and linear motions • Precise force, speed and position control • Optimised for use with servo motor EMMT-AS 	<ul style="list-style-type: none"> • Many interfaces and functions for decentralised motion functions (flying saw, flying measurement, modulo function, etc.) • Optional: integrated cam disk controllers and highly dynamic movements • Standardised interfaces allow seamless integration in mechatronic multi-axis modular systems • Reliable and easy commissioning and parameterisation with the Festo Configuration Tool (FCT) • Optionally with 3 slots, safety module or extension module • 255 position sets
→ Page/online	cmmt-as	cmmp

Electric servo drives >

Stepper motor controllers

	 Servo drives CMMT-ST	 Motor controllers CMMO-ST	 Motor controllers CMMS-ST
Nominal current, load supply		6 A	8 A
Nominal voltage, load supply DC	24 V, 48 V	24 V	48 V
Fieldbus coupling	EtherCAT, EtherNet/IP, PROFINET IRT, PROFINET RT	EtherNet	CANopen, PROFIBUS DP
Description	<ul style="list-style-type: none"> • Very efficient for tasks with low power requirements • Ideal for positioning tasks and point-to-point and interpolating motion solutions • 50% more compact than the smallest servo drive CMMT-AS • Optimised for use with stepper motors like the proven EMMS-ST 	<ul style="list-style-type: none"> • Motor controllers from the Optimised Motion Series (for electric cylinders EPCO, toothed belt axes ELGR, rotary drives ERMO) • With convenient FCT (Festo Configuration Tool) commissioning for stepper motors EMMS-ST • Quick and easy parameterisation via web browser and parameter cloud • Reliable and easy commissioning and parameterisation with the Festo Configuration Tool (FCT) • Simple control via digital I/O, IO-Link®, I-Port, Modbus TCP • Safety function safe torque off (STO) PLe • Sinusoidal current injection for especially silent motor operation • Compact design 	<ul style="list-style-type: none"> • For actuating stepper motors EMMS-ST and Optimised Motion Series (for electric cylinders EPCO, toothed belt axes ELGR, rotary drives ERMO) • Easy and convenient: commissioning and firmware updates via SD card slot • Reliable and easy commissioning and parameterisation with the Festo Configuration Tool (FCT) • Integrated process interface: digital I/O module, CAN, RS485 • Safety function Safe Torque Off (STO) PLe • Optional: PROFIBUS and DeviceNet®
→ Page/online	123	cmmo-st	124

Electric servo drives >

Positioners for process automation

	 Positioners CMSX
Standard nominal flow rate	50 ... 130 l/min
Ambient temperature	-5 ... 60°C
Setpoint value	0...10 V/0...20 mA/4...20 mA
Operating voltage range DC	21.6 ... 26.4 V
Operating pressure	3 ... 8 bar
Safety information	Safety position: opening or closing in the event of system failure, maintaining position in the event of system failure
Degree of protection	IP65
Type of mounting	Via accessories
Information on housing materials	Reinforced PC
Description	<ul style="list-style-type: none"> • Digital electropneumatic positioner for single-acting or double-acting pneumatic quarter turn actuators and double-acting pneumatic linear actuators • No air consumption in the regulated state
→ Page/online	334

Servo motors EMMT-AS



- Dynamic, brushless, permanently excited synchronous servo motors
- Extremely low cogging torque – supports high synchronisation even at low rotational speeds
- Optimised torque
- Optimised speed
- Simple connection technology (OCP: one cable plug) – hybrid cable: motor and connecting cable for supply and encoder rolled into one
- Rotatable plug

Order code

001 002 003 004 005 006 007 008 009 010
 EMMT - AS - - - - - R - - -

Legend: Mandatory entry Optional entry

001	Type
EMMT	Servo motor
002	Motor type
AS	AC synchronous
003	Motor flange size
80	80
100	100
004	Length
S	Short
M	Medium
L	Long
005	Output shaft
-	Smooth shaft

006	Rotary shaft seal
-	Without
007	Winding
LS	Low-voltage, standard
HS	High-voltage, standard
008	Electrical connection
R	Angled plug, rotatable
009	Measuring unit
S	Absolute encoder, single turn
M	Absolute encoder, multi-turn
010	Brake
-	Without
B	With brake

Product options

Motor flange size	Length	Output shaft	Rotary shaft seal
60	H Very long	K Shaft to DIN 6885	R With standard shaft sealing ring

Configurable product

This product and all its product options can be ordered online via the configurator:

→ www.festo.com/catalogue/...

Enter the part number or the type.

Part no.	Type
5185818	EMMT-AS-100-...

Ordering – Overall length short

003 Motor flange size	004 Overall length S: short		010 With brake: B	
	010 Without brake		010 With brake: B	
Type	Part no.	Type	Part no.	
007 Winding LS: low voltage, standard – 009 Measuring unit S: absolute encoder, single turn				
80	EMMT-AS-80-S-LS-RS	5255425	EMMT-AS-80-S-LS-RSB	5255427
007 Winding LS: low voltage, standard – 009 Measuring unit M: absolute encoder, multi-turn				
80	EMMT-AS-80-S-LS-RM	5255426	EMMT-AS-80-S-LS-RMB	5255428
007 Winding HS: high voltage, standard – 009 Measuring unit S: absolute encoder, single turn				
80	EMMT-AS-80-S-HS-RS	5255429	EMMT-AS-80-S-HS-RSB	5255431
100	EMMT-AS-100-S-HS-RS	5255519	EMMT-AS-100-S-HS-RSB	5255528
007 Winding HS: high voltage, standard – 009 Measuring unit M: absolute encoder, multi-turn				
80	EMMT-AS-80-S-HS-RM	5255430	EMMT-AS-80-S-HS-RMB	5255432
100	EMMT-AS-100-S-HS-RM	5255521	EMMT-AS-100-S-HS-RMB	5255529

Ordering – Overall length medium

003 Motor flange size	004 Overall length M: medium		010 With brake: B	
	010 Without brake		010 With brake: B	
Type	Part no.	Type	Part no.	
007 Winding LS: low voltage, standard – 009 Measuring unit S: absolute encoder, single turn				
80	EMMT-AS-80-M-LS-RS	5255433	EMMT-AS-80-M-LS-RSB	5255435
007 Winding LS: low voltage, standard – 009 Measuring unit M: absolute encoder, multi-turn				
80	EMMT-AS-80-M-LS-RM	5255434	EMMT-AS-80-M-LS-RMB	5255436
007 Winding HS: high voltage, standard – 009 Measuring unit S: absolute encoder, single turn				
80	EMMT-AS-80-M-HS-RS	5255437	EMMT-AS-80-M-HS-RSB	5255439
100	EMMT-AS-100-M-HS-RS	5255530	EMMT-AS-100-M-HS-RSB	5255532
007 Winding HS: high voltage, standard – 009 Measuring unit M: absolute encoder, multi-turn				
80	EMMT-AS-80-M-HS-RM	5255438	EMMT-AS-80-M-HS-RMB	5255440
100	EMMT-AS-100-M-HS-RM	5255531	EMMT-AS-100-M-HS-RMB	5255533

Ordering – Overall length long

003 Motor flange size	004 Overall length L: long		010 With brake: B	
	010 Without brake		010 With brake: B	
Type	Part no.	Type	Part no.	
007 Winding LS: low voltage, standard – 009 Measuring unit S: absolute encoder, single turn				
80	EMMT-AS-80-L-LS-RS	5255441	EMMT-AS-80-L-LS-RSB	5255443
007 Winding LS: low voltage, standard – 009 Measuring unit M: absolute encoder, multi-turn				
80	EMMT-AS-80-L-LS-RM	5255442	EMMT-AS-80-L-LS-RMB	5255444
007 Winding HS: high voltage, standard – 009 Measuring unit S: absolute encoder, single turn				
80	EMMT-AS-80-L-HS-RS	5255445	EMMT-AS-80-L-HS-RSB	5255447
100	EMMT-AS-100-L-HS-RS	5255534	EMMT-AS-100-L-HS-RSB	5255536
007 Winding HS: high voltage, standard – 009 Measuring unit M: absolute encoder, multi-turn				
80	EMMT-AS-80-L-HS-RM	5255446	EMMT-AS-80-L-HS-RMB	5255448
100	EMMT-AS-100-L-HS-RM	5255535	EMMT-AS-100-L-HS-RMB	5255537

Servo motors EMMT-AS

Accessories

Gear units EMGA-EAS				
For	Gear ratio	Gear unit flange size	Type	Part no.
EMMT-AS-60	3:1	60	EMGA-60-P-G3-EAS-60	2297686
	5:1	60	EMGA-60-P-G5-EAS-60	2297687
EMMT-AS-80	3:1	80	EMGA-80-P-G3-EAS-80	2297690
	5:1	80	EMGA-80-P-G5-EAS-80	2297691
EMMT-AS-100	3:1	80	EMGA-80-P-G3-SAS-100	552194
	5:1	80	EMGA-80-P-G5-SAS-100	552195
	3:1	120	EMGA-120-P-G3-SAS-100	552196
	5:1	120	EMGA-120-P-G5-SAS-100	552197

Motor cable NEBM-M23G15, hybrid cable				
Cable cross section	Cable length	Type	Part no.	
Straight plug and cable outlet				
1.5 mm ²	2.5 m	NEBM-M23G15-EH-2.5-Q9N-R3LEG14	5251381	
	5 m	NEBM-M23G15-EH-5-Q9N-R3LEG14	5251382	
	7.5 m	NEBM-M23G15-EH-7.5-Q9N-R3LEG14	5251383	
	10 m	NEBM-M23G15-EH-10-Q9N-R3LEG14	5251384	
	15 m	NEBM-M23G15-EH-15-Q9N-R3LEG14	5251385	
	20 m	NEBM-M23G15-EH-20-Q9N-R3LEG14	5251386	
	X length ¹⁾	NEBM-M23G15-EH-...-Q9N-R3LEG14	5251380	
2.5 mm ²	2.5 m	NEBM-M23G15-EH-2.5-Q10N-R3LEG14	5251388	
	5 m	NEBM-M23G15-EH-5-Q10N-R3LEG14	5251389	
	7.5 m	NEBM-M23G15-EH-7.5-Q10N-R3LEG14	5251390	
	10 m	NEBM-M23G15-EH-10-Q10N-R3LEG14	5251391	
	15 m	NEBM-M23G15-EH-15-Q10N-R3LEG14	5251392	
	20 m	NEBM-M23G15-EH-20-Q10N-R3LEG14	5251393	
	X length ¹⁾	NEBM-M23G15-EH-...-Q10N-R3LEG14	5251387	

1) Choice of cable lengths: 0.5 ... 99.9 m, in increments of 0.1 m.



- 2-phase hybrid technology
- Standard industrial connection technology
- Optional: encoder, brake

Order code

001 002 003 004 005 006 007 008
 EMMS - ST - [] - [] - S [] [] - []

Legend: Mandatory entry Optional entry

001	Type
EMMS	Motor
002	Motor type
ST	Stepper motor
003	Motor flange size
...	28, 42, 57, 87
004	Overall length
S	Short
M	Medium
L	Long
005	Electrical connection
S	Straight plug

006	Measuring unit
-	Without
E	Encoder
007	Brake
-	Without
B	With brake
008	Generation
-	First generation
G2	Second generation

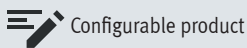

Configurable product

This product and all its product options can be ordered online via the configurator:

→ www.festo.com/catalogue/emms-st

Ordering – Overall length short, medium

003 Motor flange size	004 Overall length S: short				004 Overall length M: medium			
	007 Without brake		007 With brake: B		007 Without brake		007 With brake: B	
	Type	Part no.	Type	Part no.	Type	Part no.	Type	Part no.
	006 Without measuring unit – 008 Second generation							
42	EMMS-ST-42-S-S-G2	1370470	EMMS-ST-42-S-SB-G2	1370472				
	006 Measuring unit E: with encoder – 008 Second generation							
42	EMMS-ST-42-S-SE-G2	1370471	EMMS-ST-42-S-SEB-G2	1370473				
	006 Without measuring unit – 008 Second generation							
57	EMMS-ST-57-S-S-G2	1370474	EMMS-ST-57-S-SB-G2	1370476	EMMS-ST-57-M-S-G2	1370478	EMMS-ST-57-M-SB-G2	1370480
	006 Measuring unit E: with encoder – 008 Second generation							
57	EMMS-ST-57-S-SE-G2	1370475	EMMS-ST-57-S-SEB-G2	1370477	EMMS-ST-57-M-SE-G2	1370479	EMMS-ST-57-M-SEB-G2	1370481
	006 Without measuring unit – 008 Second generation							
87	EMMS-ST-87-S-S-G2	1370482	EMMS-ST-87-S-SB-G2	1370484	EMMS-ST-87-M-S-G2	1370486	EMMS-ST-87-M-SB-G2	1370488
	006 Measuring unit E: with encoder – 008 Second generation							
87	EMMS-ST-87-S-SE-G2	1370483	EMMS-ST-87-S-SEB-G2	1370485	EMMS-ST-87-M-SE-G2	1370487	EMMS-ST-87-M-SEB-G2	1370489

Stepper motors EMMS-ST

Ordering – Overall length long

003 Motor flange size	004 Overall length L: long			
	007 Without brake		007 With brake: B	
	Type	Part no.	Type	Part no.
	006 Without measuring unit – 008 First generation			
28	EMMS-ST-28-L-S	1451384	EMMS-ST-28-L-SB	1451383
	006 Measuring unit E: with encoder – 008 First generation			
28	EMMS-ST-28-L-SE	1430663	EMMS-ST-28-L-SEB	1451382
	006 Without measuring unit – 008 Second generation			
87	EMMS-ST-87-L-S-G2	1370490	EMMS-ST-87-L-SB-G2	1370493
	006 Measuring unit E: with encoder – 008 Second generation			
87	EMMS-ST-87-L-SE-G2	1370491	EMMS-ST-87-L-SEB-G2	1370494

Accessories

Gear unit EMGA-SST				
For	Gear ratio	Gear unit flange size	Type	Part no.
EMMS-ST-42	3:1	40	EMGA-40-P-G3-SST-42	549428
	5:1	40	EMGA-40-P-G5-SST-42	549429
EMMS-ST-57	3:1	60	EMGA-60-P-G3-SST-57	549430
	5:1	60	EMGA-60-P-G5-SST-57	549431
EMMS-ST-87	3:1	80	EMGA-80-P-G3-SST-87	549432
	5:1	80	EMGA-80-P-G5-SST-87	549433

Motor cable NEBM-S				
For ¹⁾	Cable length	Type	Part no.	
Straight plug, min. bending radius: 62 mm, suitable for use with energy chains				
EMMS-ST-28 und CMMO-ST/CMMT-ST	1.5 m	NEBM-M12G8-E-1.5-Q5-LE6	1449600	
	2.5 m	NEBM-M12G8-E-2.5-Q5-LE6	1449601	
	5 m	NEBM-M12G8-E-5-Q5-LE6	1449602	
	7 m	NEBM-M12G8-E-7-Q5-LE6	1449603	
	10 m	NEBM-M12G8-E-10-Q5-LE6	1449604	
Straight plug, min. bending radius: 62 mm, suitable for use with energy chains				
EMMS-ST-42/57 und CMMO-ST/CMMT-ST / CMMS-ST	1.5 m	NEBM-S1G9-E-1.5-Q5-LE6	1450368	
	2.5 m	NEBM-S1G9-E-2.5-Q5-LE6	1450369	
	5 m	NEBM-S1G9-E-5-Q5-LE6	1450370	
	7 m	NEBM-S1G9-E-7-Q5-LE6	1450371	
	10 m	NEBM-S1G9-E-10-Q5-LE6	1450372	
Angled plug, min. bending radius: 62 mm, suitable for use with energy chains				
EMMS-ST-42/57 und CMMO-ST/CMMT-ST / CMMS-ST	1.5 m	NEBM-S1W9-E-1.5-Q5-LE6	1450736	
	2.5 m	NEBM-S1W9-E-2.5-Q5-LE6	1450737	
	5 m	NEBM-S1W9-E-5-Q5-LE6	1450738	
	7 m	NEBM-S1W9-E-7-Q5-LE6	1450739	
	10 m	NEBM-S1W9-E-10-Q5-LE6	1450740	
Straight plug, min. bending radius: 80 mm, suitable for use with energy chains				
EMMS-ST-87 und CMMO-ST/CMMT-ST / CMMS-ST	1.5 m	NEBM-S1G15-E-1.5-Q7-LE6	1450834	
	2.5 m	NEBM-S1G15-E-2.5-Q7-LE6	1450835	
	5 m	NEBM-S1G15-E-5-Q7-LE6	1450836	
	7 m	NEBM-S1G15-E-7-Q7-LE6	1450837	
	10 m	NEBM-S1G15-E-10-Q7-LE6	1450838	
Angled plug, min. bending radius: 80 mm, suitable for use with energy chains				
EMMS-ST-87 und CMMO-ST/CMMT-ST / CMMS-ST	1.5 m	NEBM-S1W15-E-1.5-Q7-LE6	1450943	
	2.5 m	NEBM-S1W15-E-2.5-Q7-LE6	1450944	
	5 m	NEBM-S1W15-E-5-Q7-LE6	1450945	
	7 m	NEBM-S1W15-E-7-Q7-LE6	1450946	
	10 m	NEBM-S1W15-E-10-Q7-LE6	1450947	

Encoder cable NEBM-M12			
For ¹⁾	Cable length	Type	Part no.
Straight plug, min. bending radius: 51 mm, suitable for use with energy chains			
CMMS-ST	5 m	NEBM-M12G8-E-5-S1G9	550748
	10 m	NEBM-M12G8-E-10-S1G9	550749
	15 m	NEBM-M12G8-E-15-S1G9	550750
Straight plug, min. bending radius: 68 mm, suitable for use with energy chains			
CMMO-ST/CMMT-ST	1.5 m	NEBM-M12G8-E-1.5-LE8	1451586
	2.5 m	NEBM-M12G8-E-2.5-LE8	1451587
	5 m	NEBM-M12G8-E-5-LE8	1451588
	7 m	NEBM-M12G8-E-7-LE8	1451589
	10 m	NEBM-M12G8-E-10-LE8	1451590
Angled plug, min. bending radius: 68 mm, suitable for use with energy chains			
CMMO-ST/CMMT-ST	1.5 m	NEBM-M12W8-E-1.5-LE8	1451674
	2.5 m	NEBM-M12W8-E-2.5-LE8	1451675
	5 m	NEBM-M12W8-E-5-LE8	1451676
	7 m	NEBM-M12W8-E-7-LE8	1451677
	10 m	NEBM-M12W8-E-10-LE8	1451678

- 1) CMMO-ST: Motor controller → 117
 CMMS-ST: Motor controller → 124
 CMMT-ST: Motor controller → 117



Order code

001	002	003	004	005	006
CMMT	ST	C8	1C		SO

001	Type
CMMT	Motor controller
002	Motor type
ST	Stepper motor
003	Nominal current
C8	8 A
004	Nominal input voltage
1C	24 ... 48 V DC

- Space-saving servo drive for operating stepper motors and brushless direct current motors
- Extremely economical for positioning tasks and motion solutions with low power requirements up to 300 W
- Primary voltage from 24 ... 48 V DC
- Motor current from 8 A (peak 10 A)
- Integrated safety functions:
 - Safe torque off (STO)
 - Safe stop 1 (SS1-t)

Legend: Mandatory entry

005	Bus protocol/activation
EC	EtherCAT
EP	EtherNet/IP
PN	PROFINET
006	Safety function
SO	Basic safety

Configurable product

This product and all its product options can be ordered online via the configurator:

→ www.festo.com/catalogue/cmmt-st

Ordering

003 Nominal current	004 Nominal input voltage	005 Bus protocol/activation	006 Safety function	Type	Part no.
8 A	24 V DC	EtherCAT	Basic safety	CMMT-ST-C8-1C-EC-SO	8084005
		PROFINET RT/IRT		CMMT-ST-C8-1C-PN-SO	8084004
		EtherNet/IP und Modbus TCP		CMMT-ST-C8-1C-EP-SO	8084006

Accessories

Plug assortment NEKM-C ¹⁾		
Description	Type	Part no.
For single wiring connection with single-phase servo drives	NEKM-C-22	8081885

1) Included in the scope of delivery of the servo drive.

Connecting cable NEBC-R3G8			
<ul style="list-style-type: none"> • Patch cable for the daisy-chain connection of the bus interfaces X19A/B • Ethernet category Cat 5e 			
Cable length	Connection on the right	Type	Part no.
Connection on the left: straight plug, RJ45, 8-pin			
0.2 m	Straight plug, RJ45, 8-pin	NEBC-R3G8-KS-0.2-N-S-R3G8-ET	8082383

Motor controllers CMMS-ST



- No step losses and high running performance thanks to closed-loop control in servo-lite operation
- Reliable position and torque control in servo-lite operation for motors with integrated encoder
- Path interpolation, master/slave synchronisation and safe torque off safety function permit flexible and cost-efficient drive solutions
- SD card backup for fast recommissioning and convenient firmware upgrades and downgrades

Order code

001	002	003	004	005
CMMS	ST	C8	7	G2

Legend: Mandatory entry

001	Type
CMMS	Motor controller, standard
002	Motor type
ST	Stepper motor
003	Nominal current
C8	8 A

004	Input voltage
7	48 V DC
005	Generation
G2	Second generation

Ordering

003 Nominal current	004 Input voltage	Nominal voltage		Interfaces	Type	Part no.
		Load	Logic			
8 A	48 V DC	24 ... 48 V DC	24 V DC	<ul style="list-style-type: none"> • I/O interface • CANopen • PROFIBUS • DeviceNet 	CMMS-ST-C8-7-G2	572211

Accessories

Plug-in cards			
Description	Type	Part no.	
Interface module for DeviceNet® interface	CAMC-DN	547451	

Cables			
Cable length	Type	Part no.	
Control cable for I/O interface to any controller			
2.5 m	NEBC-S1G25-K-2.5N-LE26	552254	
3.2 m	NEBC-S1G25-K-3.2-N-LE25	8001373	
Programming cable			
2 m	PS1-ZK11-NULLMODEM-2,0M	160786	

Plug			
Description	Type	Part no.	
Encoder plug			
For incremental encoder interface	NECC-A-S-S1G9-C2M	564264	
Plug for PROFIBUS interface			
Sub-D, 9-pin, IP40	FBS-SUB-9-WS-PB-K	533780	
Plug for CANopen interface			
Sub-D, 9-pin, IP40	FBS-SUB-9-WS-CO-K	533783	
Plug for DeviceNet® interface			
Screw connector, 2 x 5-pin	FBSD-KL-2X5POL	525635	

Assortment of plugs			
Description	Type	Part no.	
For power supply, motor connection and safety function	NEKM-C-1 ¹⁾	547452	

1) The plug assortment is included in the scope of delivery of the motor controller.

Power supply unit			
Description	Type	Part no.	
Nominal output voltage 24 V DC, nominal output current 5 A	CACN-3A-1-5	2247681	
Nominal output voltage 24 V DC, nominal output current 10 A	CACN-3A-1-10	2247682	
Nominal output voltage 48 V DC, nominal output current 5 A	CACN-3A-7-5	2247683	
Nominal output voltage 48 V DC, nominal output current 10 A	CACN-3A-7-10	2247684	
Nominal output voltage 48 V DC, nominal output current 20 A	CACN-11A-7-20	2247685	

04

Handling systems

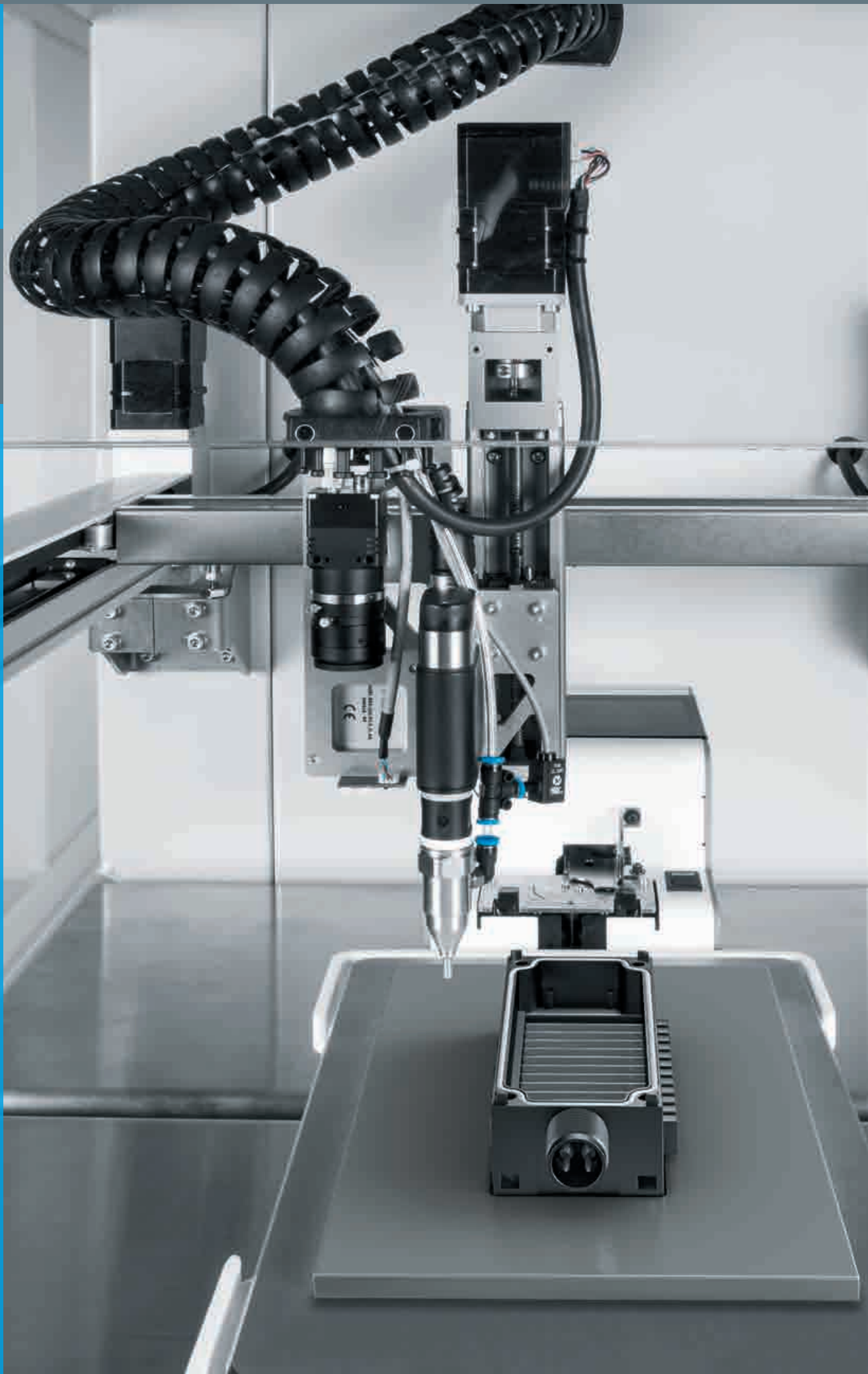

Highlights

Contents



Handling Guide Online
HGO
+ Configuration and ordering system
for standard handling systems of
the YXC... series
+ Economical and reliable
→ 128



Planar surface gantries
EXCM
Compact gantry
+ Perfectly matched drive and control-
ler packages
→ 129



Planar surface gantries
EXCH
+ Maximum working area coverage
+ Low moving mass
+ High payload
→ 129

Product overview _____ 128

Product overview

Software-Tools

**Engineering tool:
Handling Guide Online (HGO)**



Planning and designing complex handling systems, e.g. for pick & place applications, generally takes a lot of time.

With the innovative Handling Guide Online (HGO) you can design a tailor-made system in just a few steps. Simply enter your application data such as the load mass, travel and cycle time.



Advantages:

- 1D- ... 3D kinematics
- Tailor-made system solution within just a few minutes
- CAD model available immediately
- Fully automatic selection of all relevant components
- Fully automated processing including ordering function
- Fully assembled or unassembled systems

This tool is integrated in the Festo online catalogue or can be called up directly at www.festo.com/handling-guide



Cartesian robots >

Planar surface gantries

			
	Planar surface gantries, compact YXMF	Planar surface gantries, highly dynamic YXMF	2D planar surface gantries YXCF
Description	<ul style="list-style-type: none"> • Parallel kinematic drive concept with minimal space requirements • Ready-to-install complete system including energy chain, matching motors and dual motor controller • For two-dimensional movements in horizontal working areas • Flexible working area due to scalable strokes in the X and Y directions • Based on the planar surface gantry EXCM • For extremely small working areas • For desktop applications in small parts assembly, electronics manufacturing and laboratory processes 	<ul style="list-style-type: none"> • Parallel kinematic drive concept for maximum dynamic response • Ready-to-install complete system including energy chain and matching motor and motor controller package • For two-dimensional movements in horizontal working areas • Flexible working area due to scalable strokes in the X and Y directions • Based on the planar surface gantry EXCH • Maximum dynamic response and efficient operation up to max. 100 picks/min • For rapid processes with high cycle rates like pick & place, feeding parts, stacking, packaging tasks • Cost-saving alternative to two Scara robots due to large working area and high dynamic response 	<ul style="list-style-type: none"> • Ready-to-install complete system including energy chain for cables or tubing as well as matching motor and motor controller package • For two-dimensional movements in horizontal working areas • Flexible working area due to scalable strokes in the X and Y directions • X-axis based on toothed belt axis EGC-TB • Y-axis based on the toothed belt axis EGC-TB and toothed belt axis with heavy-duty guide EGC-HD-TB • Especially suitable for very long strokes
→ Page/online	yxmf	yxmf	yxcf

Cartesian robots >

Planar surface gantries

	 <p>2D planar surface gantries EXCM</p>	 <p>2D planar surface gantries EXCH</p>
<p>Description</p>	<ul style="list-style-type: none"> • Excellent functionality in confined spaces • Low moving dead weight • Actuation via two stepper motors with integrated optical encoder and two-axis controller • With recirculating ball bearing guide 	<ul style="list-style-type: none"> • Optimal dynamic response when compared with other Cartesian gantry systems • Drive concept with low moving dead weight • Flat system design • High acceleration in both axial directions • Large working area
<p>→ Page/online</p>	<p>excm</p>	<p>exch</p>

05

Vacuum technology

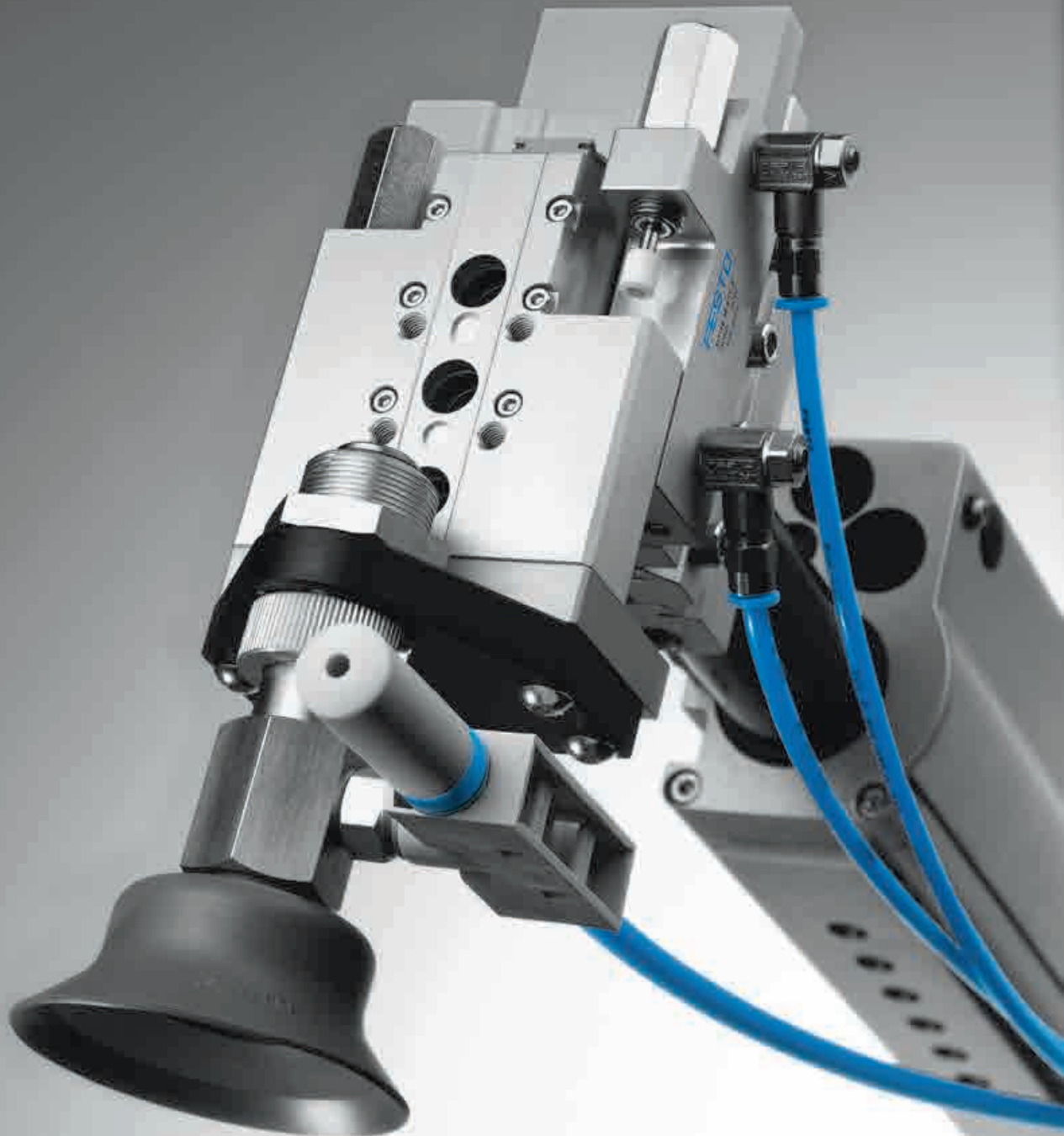

Highlights

Contents

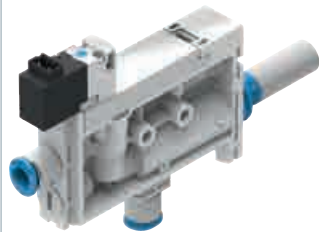

Vacuum generators
OVEL
+ Ideal for fast small parts handling
+ Lightweight design for installing in the gripping area
→ 134

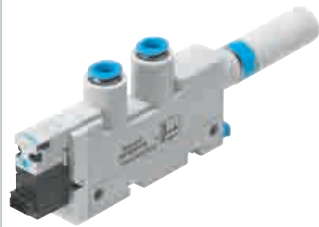

Vacuum generators
VN
+ Generate a vacuum easily and quickly
+ Lightweight design for installing in the gripping area
→ 136



Product overview	132
Vacuum generators OVEL	134
Vacuum generators VN	136
Suction cups VAS/VASB	138
Suction grippers ESG – Overview	140

Product overview

Software-Tools



Vacuum selection		<p>Which suction cup for which surface and which movement? Don't experiment – calculate! This software tool even enables a distinction to be made between linear and rotary movements.</p> <p>This tool can be found</p> <ul style="list-style-type: none"> on our website at www.festo.com/catalogue by clicking on the blue button "Engineering".
-------------------------	---	---

Vacuum generators



	 Vacuum generators OVEL	 Vacuum generators OVEM	 Vacuum generators, pneumatic VN
Nominal width of Laval nozzle	0.45 ... 0.95 mm	0.45 ... 3 mm	0.45 ... 3 mm
Ejector characteristic	High suction rate, high vacuum, standard	High suction rate, high vacuum, standard	High suction rate, high vacuum, standard, inline, high vacuum, high suction rate
Integrated function	Electrical ejector pulse, flow control valve, pressure sensor, pressure transmitter, electric on/off valve, filter, open silencer	Electric ejector pulse valve, flow control valve, electric on/off valve, filter, electric air saving function, check valve, open silencer, vacuum switch	Pneumatic ejector pulse valve, open silencer, vacuum switch
Max. vacuum	89 ... 92%	93%	86 ... 93%
Max. suction rate with respect to atmosphere	4 ... 21 l/min	6 ... 348 l/min	6.1 ... 339 l/min
Description	<ul style="list-style-type: none"> Low-cost, compact vacuum generator Low weight Various performance levels and vacuum types Short switching times thanks to integrated solenoid valves Quick, precise and safe placing of the workpiece via ejector pulse Easy to mount Minimal installation work required 	<ul style="list-style-type: none"> Compact design Monitoring with vacuum sensor with IO-Link® Central electrical connection via an M12 plug Maintenance-free operation and reduced noise level through an integrated, open silencer Integrated filter with inspection window Optionally with air-saving function and LCD display Adjustable ejector pulse 	<ul style="list-style-type: none"> Can be used directly in the work space Available as straight type (in-line: vacuum port in line with the supply port) or T-shape (standard: vacuum port at 90° to the supply port) Compact and cost-effective Maintenance-free operation and reduced noise level through an integrated, open silencer
→ Page/online	134	ovem	136

Classic >

Vacuum generators

	 Vacuum generators VAD	 Vacuum generators VAK
Nominal width of Laval nozzle	0.5 mm ... 2 mm	1 mm
Ejector characteristics	High vacuum	High vacuum
Integrated function	Electric ejector pulse, electric on/off valve	Pneumatic ejector pulse
Max. vacuum	80 ... 90%	80%
Description	<ul style="list-style-type: none"> • Range of vacuum generators with sturdy aluminium housing • Minimal installation effort • Short switching times • Built-in solenoid valve (on/off) • Workpieces can be picked up in any position 	<ul style="list-style-type: none"> • Range of vacuum generators with sturdy aluminium housing • Quick and reliable setting down of parts via an ejector pulse from a pre-filled reservoir • Robust vacuum generator for a broad field of applications • Optional silencer
→ Page/online	vad	vak

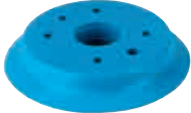
Vacuum gripping technology

	 Suction cups with connector ESS	 Suction cups without connector ESV	 Suction cups with connector VAS, VASB	 Suction grippers ESG
Suction cup size	4x20 mm, 6x10 mm, 6x20 mm, 8x20 mm, 8x30 mm, 4x10 mm, 10x30 mm, 15x45 mm, 20x60 mm, 25x75 mm, 30x90 mm			4x20 mm, 6x10 mm, 6x20 mm, 8x20 mm, 8x30 mm, 4x10 mm, 10x30 mm, 15x45 mm, 20x60 mm, 25x75 mm, 30x90 mm
Suction cup diameter	2 ... 200 mm	20 ... 200 mm	2 ... 125 mm	2 ... 200 mm
Holding force at nominal operating pressure	0.1 ... 1610 N	8.2 ... 1610 N	0.14 ... 700 N	
Design	Round, bell-shaped	Bell-shaped or round bellows		Vacuum port on top, vacuum port on the side, with height compensator, with long height compensator
Information on suction cup materials	BR, FPM, NBR, PUR, VMQ (silicone), Vulkollan®	BR, FPM, NBR, PUR, VMQ (silicone), Vulkollan®	NBR, PUR, TPE-U (PU), VMQ (silicone)	BR, FPM, NBR, PUR, VMQ (silicone), Vulkollan®
Description	<ul style="list-style-type: none"> • Suction cup consisting of the suction cup itself, plus the support plate with mounting • Suction cup volume: 0.002 ... 245 cm³ • Min. workpiece radius: 10 ... 680 mm • Mounting for suction cup holder: female thread, male thread, push-in connector • Suction cup with mounting thread 	<ul style="list-style-type: none"> • Wearing part for suction cup ESS • Easily interchangeable • Suction cup volume: 0.318 ... 245 cm³ • Min. workpiece radius: 10 ... 680 mm 	<ul style="list-style-type: none"> • Sturdy and reliable • Suction cup with fixed connecting thread • 11 suction cup diameters • Round suction cup shape, bellows • Vacuum port on top, on the side • Screw-in thread 	<ul style="list-style-type: none"> • Modular system of suction cup holders and suction cups with over 5000 variants • Optionally with angle compensator, height compensator, filter • 15 suction cup diameters • 6 suction cup shapes • Suction cup volume: 0.002 ... 245 cm³ • Min. workpiece radius: 10 ... 680 mm • Vacuum port: push-in connector or barbed fitting for plastic tubing, threaded connection
→ Page/online	ess	esv	138	140

Vacuum generators >

Vacuum generators OVEL

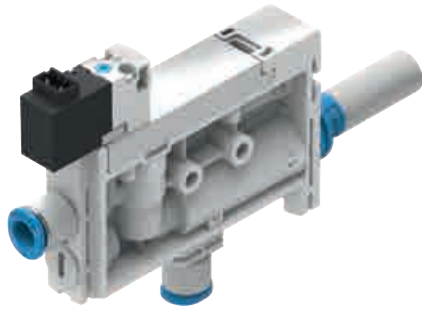

- Various performance levels and vacuum types
- Short switching times thanks to integrated solenoid valves
- Quick, precise and safe placing of the workpiece via ejector pulse
- Compact and lightweight design for installing in the gripping area
- Ideal for fast small parts handling
- Maintenance-free open silencer

Order code

001	002	003	004	005	006	007	008	009	010	011	012	013
OVEL		H		PQ		UA		C	A			H3

001	Type
OVEL	Vacuum generator, electropneumatic
002	Nominal width of Laval nozzle
5	0.45 mm
7	0.7 mm
10	0.95 mm
003	Ejector characteristic
H	High vacuum
004	Housing width
10	Grid dimension 10 mm
15	Grid dimension 15 mm
005	Pneumatic connection 1
PQ	Push-in connectors, metric
006	Vacuum connection
VQ4	Push-in connector 4 mm
VQ6	Push-in connector 6 mm
007	Pneumatic connection 3
UA	Open silencer

008	Ejector pulse connection
-	Via pneumatic connection 1
009	Vacuum valve
C	Normally closed
010	Additional function
A	Ejector pulse, electrical
011	Vacuum sensor pressure measuring range
B2	-1 ... 1 bar
V1	-1 ... 0 bar
012	Vacuum sensor output signal
B	1 ... 5 V
V	0 ... 10 V
PNLK	PNP or NPN or IO-Link®
013	Electrical connection
H3	Connection pattern H, vertical plug

Legend: Mandatory entry Optional entry

Product options

Pneumatic connection 1 P For pneumatic linking via manifold rail	Vacuum connection VQ3 Push-in connector 3 mm	Ejector pulse connection Z Additional connection (like pneumatic connection 1)	Vacuum sensor pressure measuring range - Without vacuum sensor
Ejector characteristic L High suction rate	Pneumatic connection 3 RQ Push-in connectors, metric	Additional function - Without ejector pulse	Vacuum sensor output signal - Without vacuum sensor

Configurable product

This product and all its product options can be ordered online via the configurator:

→ www.festo.com/catalogue/...

Enter the part number or the type.

Part no.	Type
8049045	OVEL

Ordering – Basic design

With push-in connector at pneumatic connection 1 and vacuum connection, open silencer at pneumatic connection 3, with vacuum sensor, ejector pulse and connection pattern H, vertical plug

004 Housing width	006 Vacuum connection	011 Vacuum sensor pressure measuring range	012 Vacuum sensor output signal	Type	Part no.
002 Nominal width of Laval nozzle 0.45 mm					
Grid dimension 10 mm	Push-in connector 4 mm	-1 ... 0 bar	1 ... 5 V	OVEL-5-H-10-PQ-VQ4-UA-C-A-V1B-H3	8049046
		-1 ... 0 bar	0 ... 10 V	OVEL-5-H-10-PQ-VQ4-UA-C-A-V1V-H3	8049049
		-1 ... 0 bar	PNP or NPN or IO-Link®	OVEL-5-H-10-PQ-VQ4-UA-C-A-V1PNLK-H3	8049052
		-1 ... 1 bar	0 ... 10 V	OVEL-5-H-10-PQ-VQ4-UA-C-A-B2V-H3	8069567
		-1 ... 1 bar	PNP or NPN or IO-Link®	OVEL-5-H-10-PQ-VQ4-UA-C-A-B2PNLK-H3	8069570
002 Nominal width of Laval nozzle 0.7 mm					
Grid dimension 15 mm	Push-in connector 4 mm	-1 ... 0 bar	1 ... 5 V	OVEL-7-H-15-PQ-VQ4-UA-C-A-V1B-H3	8049047
		-1 ... 0 bar	0 ... 10 V	OVEL-7-H-15-PQ-VQ4-UA-C-A-V1V-H3	8049050
		-1 ... 0 bar	PNP or NPN or IO-Link®	OVEL-7-H-15-PQ-VQ4-UA-C-A-V1PNLK-H3	8049053
		-1 ... 1 bar	0 ... 10 V	OVEL-7-H-15-PQ-VQ4-UA-C-A-B2V-H3	8069568
		-1 ... 1 bar	PNP or NPN or IO-Link®	OVEL-7-H-15-PQ-VQ4-UA-C-A-B2PNLK-H3	8069571
002 Nominal width of Laval nozzle 0.95 mm					
Grid dimension 15 mm	Push-in connector 6 mm	-1 ... 0 bar	1 ... 5 V	OVEL-10-H-15-PQ-VQ6-UA-C-A-V1B-H3	8049048
		-1 ... 0 bar	0 ... 10 V	OVEL-10-H-15-PQ-VQ6-UA-C-A-V1V-H3	8049051
		-1 ... 0 bar	PNP or NPN or IO-Link®	OVEL-10-H-15-PQ-VQ6-UA-C-A-V1PNLK-H3	8049054
		-1 ... 1 bar	0 ... 10 V	OVEL-10-H-15-PQ-VQ6-UA-C-A-B2V-H3	8069569
		-1 ... 1 bar	PNP or NPN or IO-Link®	OVEL-10-H-15-PQ-VQ6-UA-C-A-B2PNLK-H3	8069572

Accessories

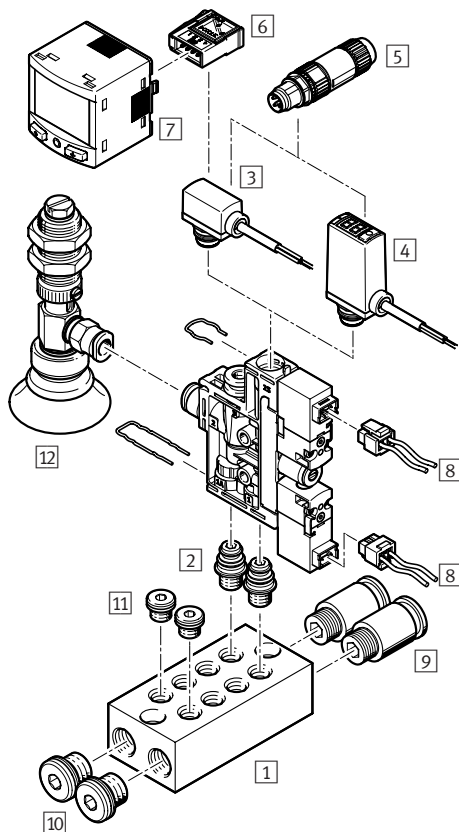

- 1 Common supply manifold OABM-P
→ [ovel](#)
- 2 Mounting kit OABM-MK → [ovel](#)
- 3 Pressure transmitter SPTE → [ovel](#)
- 4 Pressure sensor SPAE → 234
- 5 Plug NECU-S-M8G3/M12G3
→ [ovel](#)
- 6 Plug NECU-S-ECG4 → [ovel](#)
- 7 Signal converter SCDN → [ovel](#)
- 8 Plug socket with cable NEBV
→ [ovel](#)
- 9 Push-in fitting QS → 293
- 10 Blanking plug B-1/8 → 305
- 11 Blanking plug B-M7 → 305
- 12 Suction gripper ESG → 140
Suction cup holder ESH → 140
Suction cup ESS → 140
Vacuum filter OAFF → [ovel](#)

Vacuum generators >

Vacuum generators VN

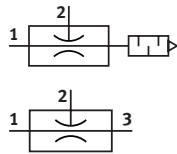
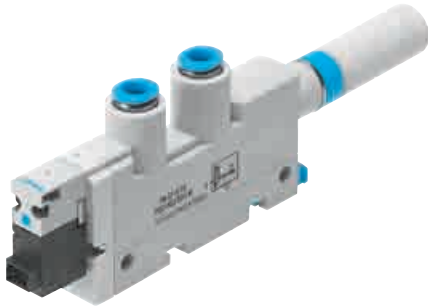

- High vacuum levels of up to 93%
- Easy connection of holders and suction cups
- Lightweight and compact design thanks to plastic housing
- No wearing parts, long service life
- Vacuum monitoring via vacuum switch
- Low environmental impact due to silencers

Order code

001	002	003	004	005	006	007	008
VN		H	T				

Legend: Mandatory entry

001	Type
VN	Vacuum generator, pneumatic
002	Nominal width of Laval nozzle [mm]
05	0.45
07	0.7
10	0.95
14	1.4
20	2
30	3
003	Ejector characteristic
H	High vacuum/standard
004	Design
T	T-shape
005	Size
2	Grid dimension 10 mm
3	Grid dimension 14 mm
4	Grid dimension 18 mm
6	Grid dimension 24 mm

006	Pneumatic connection 1
PQ1	Push-in fitting QS-4
PQ2	Push-in fitting QS-6
PQ4	Push-in fitting QS-10
007	Vacuum port (V)
VQ1	Push-in fitting QS-4
VQ2	Push-in fitting QS-6
VQ3	Push-in fitting QS-10
VQ5	Push-in fitting QS-12
008	Pneumatic connection 3
RQ1	Push-in fitting QS-4
R01	Silencer UO, open
R02	Silencer UOM, open

Product options

Ejector characteristic:

- L High suction rate/standard
- M High vacuum/inline
- N High suction rate/inline

Housing type:

- I2 Straight, grid dimension 10 mm
- I3 Straight, grid dimension 13 mm

Connection options:

- Female thread
- Male thread
- Push-in sleeve

Configurable product

This product and all its product options can be ordered online via the configurator:

→ www.festo.com/catalogue/vn

Ordering – Basic design

002 Nominal width of Laval nozzle [mm]	004 Design, 005 Size	007 Vacuum port (V)	Type	Part no.
0.45	T2: T-type, grid dimension 10 mm	QS-4	VN-05-H-T2-PQ1-VQ1-RQ1	526100
0.7	T2: T-type, grid dimension 10 mm	QS-4	VN-07-H-T2-PQ1-VQ1-RQ1	526101
0.95	T3: T-type, grid dimension 14 mm	QS-6	VN-10-H-T3-PQ2-VQ2-R01	193490
1.4	T4: T-type, grid dimension 18 mm	QS-8	VN-14-H-T4-PQ2-VQ3-R02	547707
2	T6: T-type, grid dimension 24 mm	QS-12	VN-20-H-T6-PQ4-VQ5-R02	193495
3	T6: T-type, grid dimension 24 mm	QS-12	VN-30-H-T6-PQ4-VQ5-R02	193497

Accessories

VN-05/07/10/14

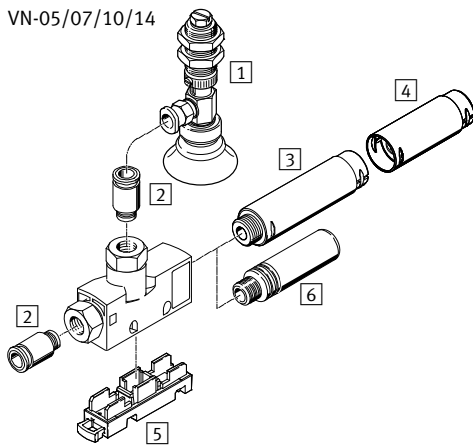

VN-20/30

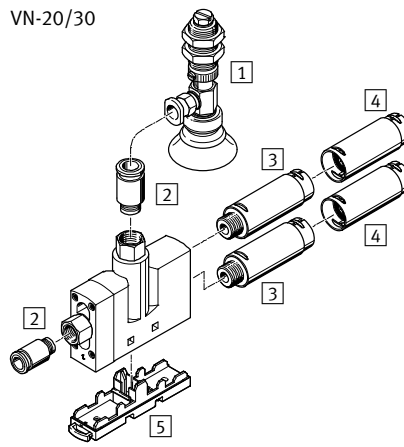

- 1) Suction gripper ESG (complete solution) → 140
Suction cup holder ESH with Suction cup ESS (individual components) → 140
- 2) Push-in fitting QS → 293
- 3) Silencer UOM → 137
- 4) Silencer extension UOMS → 137
- 5) Mounting plate VN-T → 137
- 6) Silencer UO → [vn](#)

Silencer AMTE → 137

3) Silencer UOM

For grid dimension	Pneumatic connection	Type	Part no.
18 mm	G1/4	UOM-1/4	538432
24 mm	G3/8	UOM-3/8	538433

4) Silencer extension UOMS

For silencer	Type	Part no.
UOM-1/4	UOMS-1/4	538436
UOM-3/8	UOMS-3/8	538437

5) Mounting plate VN-T

For grid dimension	Type	Part no.
10 mm	VN-T2-BP-NRH	196951
14 mm	VN-T3-BP-NRH	193641
18 mm	VN-T4-BP-NRH	195279
24 mm	VN-T6-BP-NRH ¹⁾	196956

1) Horizontal wall mounting not permissible.

Silencer AMTE¹⁾, long version

For grid dimension	Pneumatic connection	Type	Part no.
10 mm	M5	AMTE-M-LH-M5	1205858
14 mm	G1/8	AMTE-M-LH-G18	1205860
18 mm	G1/4	AMTE-M-LH-G14	1205861

1) Packaging unit 20 pieces

Vacuum gripping technology >
Suction cups VAS/VASB



- The ideal solution for transporting workpieces of different weights, surfaces and shapes
- Wide range to suit applications with various temperature ranges and workpiece surfaces
- Suction cups made from silicone are food-safe
- All tubing connection sizes correspond to a holder size

Order code

001 002 003 004 005 006
 - - - - -

Legend: Mandatory entry Optional entry

001	Type
VAS	Suction cup, round, flat
VASB	Suction cup, round, bellows with 1.5 convolutions
002	Suction cup Ø [mm]
...	2, 5, 8, 10, 15, 30, 40, 55, 75, 100, 125
003	Vacuum connection
PK-3	PK-3
M3	M3 thread
M5	M5 thread
1/8	G1/8 thread
1/4	G1/4 thread
3/8	G3/8 thread

004	Suction cup shape
-	Round, flat
S	Round, flat
005	Suction cup material
PUR	TPE-U(PU), suction cup shape S
NBR	Nitrile rubber
SI	VMQ (silicone)
PUR	Polyurethane
006	Generation
-	A series
B	B series

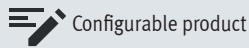

Configurable product

This product and all its product options can be ordered online via the configurator:

→ www.festo.com/catalogue/vas

Ordering – Suction cup shape round, flat

002 Suction cup Ø	003 Vacuum connection	Connection position	004 Suction cup shape	Type of mounting	Type	Part no.
005 Suction cup material: TPE-U(PU)						
8 mm	PK-3	On side	Round, flat	M5	VAS-8-M5-S-PUR-B	8025969
005 Suction cup material: NBR						
2 mm	M3	On top	Round, flat	Via vacuum connection	VAS-2-M3-NBR	173438
5 mm	M5				VAS-5-M5-NBR	173439
8 mm	M5				VAS-8-M5-NBR	34588
10 mm	M5				VAS-10-M5-NBR	173440
15 mm	G1/8				VAS-15-1/8-NBR	36142
30 mm	G1/8				VAS-30-1/8-NBR	34587
40 mm	G1/4				VAS-40-1/4-NBR	36143
55 mm	G1/4				VAS-55-1/4-NBR	36144
75 mm	G1/4				VAS-75-1/4-NBR	36145
100 mm	G1/4				VAS-100-1/4-NBR	34586
125 mm	G3/8	VAS-125-3/8-NBR	152605			

Ordering – Suction cup shape round, flat

002 Suction cup Ø	003 Vacuum connection	Connection position	004 Suction cup shape	Type of mounting	Type	Part no.
005 Suction cup material: VMQ (silicone)						
8 mm	M5	On top	Round, flat	Via vacuum connection	VAS-8-M5-SI-B	1377781
10 mm	M5				VAS-10-M5-SI-B	1385610
15 mm	G1/8				VAS-15-1/8-SI-B	1376604
30 mm	G1/8				VAS-30-1/8-SI-B	1377752
40 mm	G1/4				VAS-40-1/4-SI-B	1379454
55 mm	G1/4				VAS-55-1/4-SI-B	1379348
75 mm	G1/4				VAS-75-1/4-SI-B	1382165
100 mm	G1/4				VAS-100-1/4-SI-B	1386376
125 mm	G3/8				VAS-125-3/8-SI-B	1415120
005 Suction cup material: PUR						
8 mm	M5	On top	Round, flat	Via vacuum connection	VAS-8-M5-PUR-B	1396086
10 mm	M5				VAS-10-M5-PUR-B	1469698
15 mm	G1/8				VAS-15-1/8-PUR-B	1396087
30 mm	G1/8				VAS-30-1/8-PUR-B	1396090
40 mm	G1/4				VAS-40-1/4-PUR-B	1396092
55 mm	G1/4				VAS-55-1/4-PUR-B	1396095
75 mm	G1/4				VAS-75-1/4-PUR-B	1396096
100 mm	G1/4				VAS-100-1/4-PUR-B	1396098
125 mm	G3/8				VAS-125-3/8-PUR-B	1396108

Ordering – Bellows

002 Suction cup Ø	003 Vacuum connection	Connection position	004 Suction cup shape	Type of mounting	Type	Part no.
005 Suction cup material: NBR						
8 mm	M5	On top	Round, bellows with 1.5 convolutions	Via vacuum connection	VASB-8-M5-NBR	35410
15 mm	G1/8				VASB-15-1/8-NBR	35411
30 mm	G1/8				VASB-30-1/8-NBR	35412
40 mm	G1/4				VASB-40-1/4-NBR	35413
55 mm	G1/4				VASB-55-1/4-NBR	35414
75 mm	G1/4				VASB-75-1/4-NBR	35415
100 mm	G1/4				VASB-100-1/4-NBR	35416
125 mm	G3/8				VASB-125-3/8-NBR	152609
005 Suction cup material: VMQ (silicone)						
8 mm	M5	On top	Round, bellows with 1.5 convolutions	Via vacuum connection	VASB-8-M5-SI-B	1394696
15 mm	G1/8				VASB-15-1/8-SI-B	1377689
30 mm	G1/8				VASB-30-1/8-SI-B	1377637
40 mm	G1/4				VASB-40-1/4-SI-B	1372910
55 mm	G1/4				VASB-55-1/4-SI-B	1373812
75 mm	G1/4				VASB-75-1/4-SI-B	1378427
100 mm	G1/4				VASB-100-1/4-SI-B	1382277
125 mm	G3/8				VASB-125-3/8-SI-B	1387375
005 Suction cup material: PUR						
8 mm	M5	On top	Round, flat	Via vacuum connection	VASB-8-M5-PUR-B	1395637
15 mm	G1/8				VASB-15-1/8-PUR-B	1395671
30 mm	G1/8				VASB-30-1/8-PUR-B	1395690
40 mm	G1/4				VASB-40-1/4-PUR-B	1395691
55 mm	G1/4				VASB-55-1/4-PUR-B	1396063
75 mm	G1/4				VASB-75-1/4-PUR-B	1396064
100 mm	G1/4				VASB-100-1/4-PUR-B	1396066
125 mm	G3/8				VASB-125-3/8-PUR-B	1396067

Vacuum gripping technology >
Suction grippers ESG – Overview

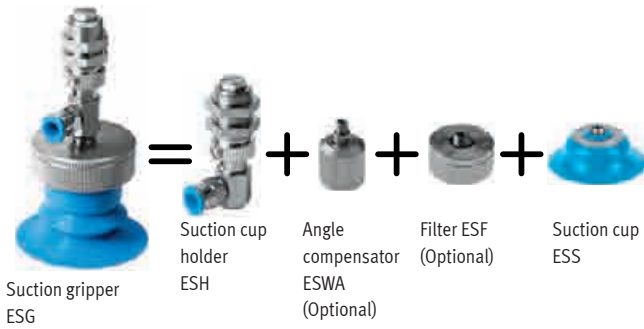

- Any combination of suction cup holder ESH and suction cup with connection attachments ESS is possible in the same holder size
- 15 suction cup diameters from 2 ... 200 mm
- 6 different materials – including anti-static ones

- 6 suction cup shapes
- Numerous suction cup holders
- Suitable for a wide variety of temperature ranges and workpiece surfaces

Product options

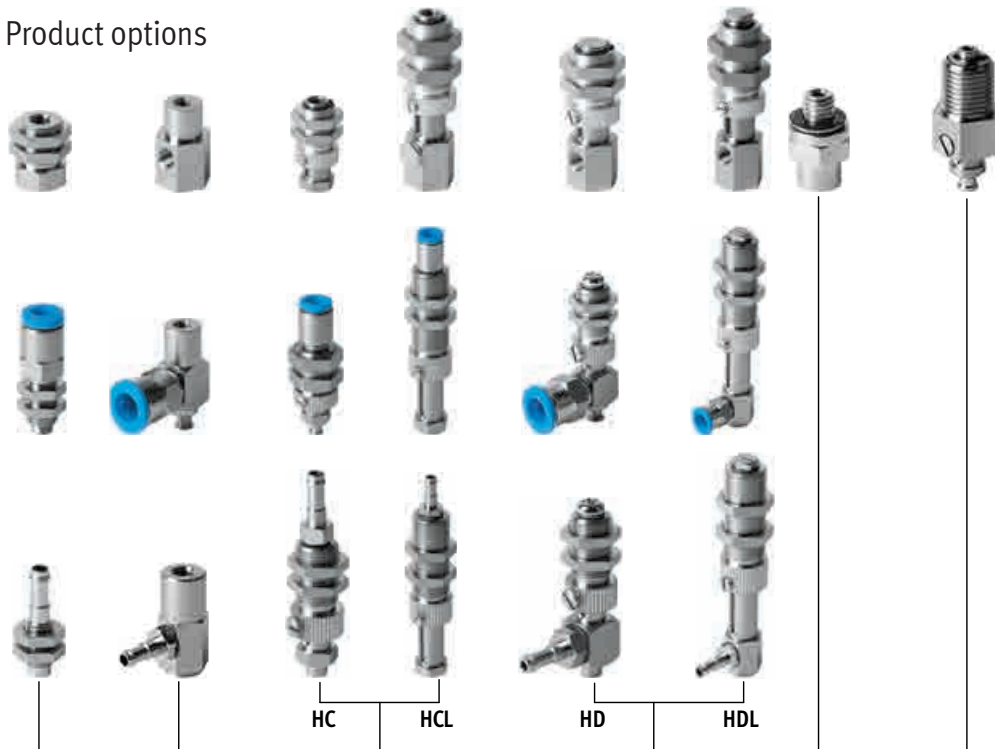

Suction cup holder ESH → [esh](#)

Threaded connection G
For suction cup diameter 60 ... 200 mm
For suction cup size 15x45 ... 30x90 mm

Push-in connector QS
For suction cup diameter 2 ... 50 mm
For suction cup size 4x10 ... 10x30 mm

Barbed connector PK
For suction cup diameter 2 ... 50 mm
For suction cup size 4x10 ... 10x30 mm

HA	HB	HC	HCL	HD	HDL	HE	HF
2 ... 200	2 ... 200	2 ... 200	4 ... 200	2 ... 200	4 ... 200	2 ... 200	2 ... 50
4x10 ... 30x90	4x10 ... 30x90	4x10 ... 30x90	4x10 ... 30x90	4x10 ... 30x90	4x10 ... 30x90	4x10 ... 30x90	4x10 ... 10x30

Holder type
For suction cup diameter [mm]
For suction cup size [mm]

Angle compensator ESWA → [eswa](#)

Vacuum filter ESF → [esf](#)

Suction cup ESS → [ess](#)

- FPM (fluoro rubber)
- NBR (nitrile rubber)
- BR (butadiene rubber), anti-static
- VMQ (silicone)
- PUR (polyurethane)
- Vulkollan®



Configurable product

This product and all its product options can be ordered online via the configurator:

→ www.festo.com/catalogue/esg

06

Valves

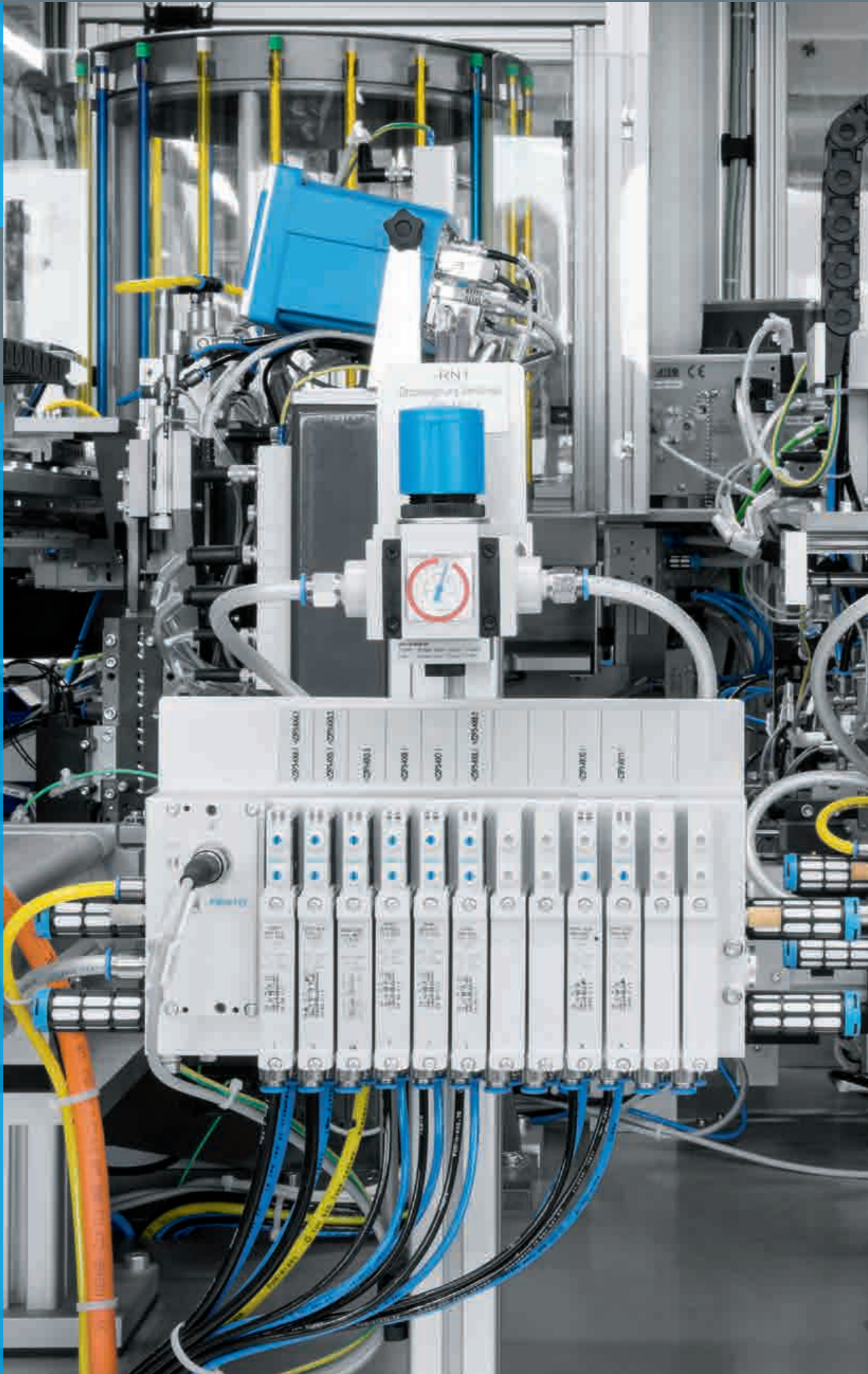

Highlights



Solenoid valves, NAMUR
VSNC
+ Certified in accordance with established explosion standards
+ Sturdy and with high flow rates
→ 157



Universal directional control valves
VUUG
+ Universal valve, sturdy and durable
+ Can be used as an individual valve or manifold valve VTUG
→ 164



Universal directional control valves
VUVS-L
+ Piston spool with sealing cartridge (VUVS-L) or sealing ring (VUVS-LK)
+ Can be used as an individual valve or manifold valve VTUS
→ 169





Contents

Product overview	144
Solenoid valves VSNC, NAMUR	157
Solenoid valves VSVA, to ISO 5599-1	160
Solenoid valves VSVA, to ISO 15407-1	162
Solenoid valves VUUG	164
Solenoid valves VUUS-L	169
Hand lever valves VHEF-HS	173
Hand lever valves VHER	175
Pushbutton valves VHEF-P	177
Finger lever valves VHEF-L	179
Selector valves VHEF-ES	181
Stem actuated valves VMEF-S	183
Roller lever valves VMEF-R	185
Roller lever valves VMEF-K	187
Check valves, piloted HGL	189
Hand slide valves VBOH	190
Ball valves QH, manual	191
One-way flow control valves GRLA, GRLZ	192

Product overview





Electrically and pneumatically actuated directional control valves >

Standards-based directional control valves

	 Solenoid valves VSNC	 Standards-based valves with central plug VSVA-R5, VSVA-R2	 Standards-based valves with indi- vidual plug VSVA-C1, VSVA-P1	 Standards-based valves, plug-in VSVA-T1
Actuation type	Electrical	Electrical	Electrical	Electrical
Pneumatic connection 1	1/4 NPT, G1/4, QS-1/4, QS-10, QS-3/8, QS-5/16, QS-6, QS-8	Sub-base size 1 to ISO 5599-1, size 2 to ISO 5599-1	Sub-base size 18 to ISO 15407-1, size 26 to ISO 15407-1	Sub-base size 1 to ISO 5599-2, size 2 to ISO 5599-2, size 18 to ISO 15407-2, size 26 to ISO 15407-2
Operating pressure	1.5 ... 10 bar	-0.9 ... 16 bar	-0.9 ... 16 bar	-0.9 ... 10 bar
Standard nominal flow rate	800 ... 1350 l/min	400 ... 2800 l/min	400 ... 1400 l/min	370 ... 2900 l/min
Valve function	5/2-way, double solenoid, 5/2 or 3/2-way, convertible, 5/3-way, pressurised, 5/3-way, exhausted, 5/3-way, closed	2x2/2-way, single solenoid, closed, 2x3/2-way, single solenoid, closed, 2x3/2-way, single solenoid, open, 2x3/2-way, single solenoid, open/closed, 5/2-way, double solenoid, 5/2-way, double solenoid, dominant signal, 5/2-way, single solenoid, 5/3-way, pressurised, 5/3-way, exhausted, 5/3-way, closed	2x2/2-way, single solenoid, closed, 2x3/2-way, single solenoid, closed, 2x3/2-way, single solenoid, open, 2x3/2-way, single solenoid, open/closed, 5/2-way, double solenoid, 5/2-way, double solenoid, dominant signal, 5/2-way, single solenoid, 5/3-way, pressurised, 5/3-way, exhausted, 5/3-way, closed	2x2/2-way, single solenoid, closed, 2x3/2-way, single solenoid, closed, 2x3/2-way, single solenoid, open, 2x3/2-way, single solenoid, open/closed, 5/2-way, double solenoid, 5/2-way, double solenoid, dominant signal, 5/2-way, single solenoid, 5/3-way, pressurised 1 to 2, 4 to 5 closed, 5/3-way, pressurised, 5/3-way, exhausted, 5/3-way, closed, 5/3-way, port 2 pressurised, 4 exhausted, 5/3-way, port 4 pressurised, 2 exhausted
Electrical connection	3-pin, type A, type B, cable conduit fitting M20x1.5, plug, to EN 175301-803, to industry standard (11 mm)	3-pin, 4-pin, central plug, round design, M8x1, M12x1	Type C, with protective earth conductor, to DIN EN 175301-803, to EN 175301-803, without protective earth conductor	2-pin, 4-pin, plug-in, plug, to ISO 15407-2, to ISO 5599-2
Description	<ul style="list-style-type: none"> • Connection pattern to NAMUR to VDI/VDE 3845 • Replaceable seal for 3/2-way or 5/2-way valve • Wide choice of EX solenoid systems • Sturdy and powerful • Extended temperature range • Outstanding value for money • All solenoid coils can be used on an armature tube • The variant VSNC-...FN achieves increased energy efficiency thanks to reduced power consumption 	<ul style="list-style-type: none"> • Conforms to ISO 5599-1 • Electrical connection via central plug • Sturdy metal housing • Manifold assembly with mixture of sizes possible 	<ul style="list-style-type: none"> • Conforms to ISO 15407-1 and to ISO 15218 for pilot valve with interface • Electrical connection via type C plug • Sturdy metal housing • Manifold assembly with mixture of sizes possible 	<ul style="list-style-type: none"> • For valve terminal VTSA/VTSA-F • Sturdy metal housing
→ Page/online	157	160	162	vsva

Electrically and pneumatically actuated directional control valves >



Universal directional control valves

	 Solenoid valves, for individual connection VUVG	 Solenoid valves, plug-in VUVG-T1	 Solenoid valves VUVS	 Solenoid and pneumatic valves, Tiger Classic MFH, MOFH, JMFH, JMFHDH, VL/O, VL, JH, JDH
Actuation type	Electrical	Electrical	Electrical	Electrical, pneumatic
Pneumatic connection 1	G1/4, G1/8, M3, M5, M7		1/8 NPT, G1/4, G1/8, G3/8	G1/2, G1/4, G1/8, G3/4
Pneumatic working port	G1/4, G1/8, M3, M5, M7, QS-1/4, QS-1/8, QS-10, QS-3, QS-3/16, QS-3/8, QS-4, QS-5/16, QS-5/32, QS-6, QS-8	Flange, G1/4, G1/8, M5, M7	1/8 NPT, 1/4 NPT, 3/8 NPT, G1/4, G1/8, G3/8, QS-1/2, QS-1/4, QS-10, QS-12, QS-3/8, QS-4, QS-5/16, QS-5/32, QS-6, QS-8	G1/2, G1/4, G1/8, G3/4
Operating pressure	-0.9 ... 10 bar	-0.9 ... 10 bar	-0.9 ... 10 bar	-0.95 ... 10 bar
Standard nominal flow rate	80 ... 1380 l/min	130 ... 1200 l/min	500 ... 2400 l/min	500 ... 7500 l/min
Valve function	2x3/2-way, single solenoid, closed, 2x3/2-way, single solenoid, open, 2x3/2-way, single solenoid, open/closed, 5/2-way, double solenoid, 5/2-way, single solenoid, 5/3-way, pressurised, 5/3-way, exhausted, 5/3-way, closed	2x3/2-way, single solenoid, closed, 2x3/2-way, single solenoid, open, 2x3/2-way, single solenoid, open/closed, 3/2-way, single solenoid, closed, 3/2-way, single solenoid, open, 5/2-way, double solenoid, 5/2-way, single solenoid, 5/3-way, pressurised, 5/3-way, exhausted, 5/3-way, closed	2x3/2-way, single solenoid, closed, 2x3/2-way, single solenoid, open, 2x3/2-way, single solenoid, open/closed, 3/2-way, single solenoid, closed, 3/2-way, single solenoid, open, 5/2-way, double solenoid, 5/2-way, single solenoid, 5/3-way, pressurised, 5/3-way, exhausted, 5/3-way, closed	3/2-way, single solenoid/monostable, closed, 3/2-way, single solenoid/monostable, open, 3/2-way, single solenoid/monostable, open/closed, 5/2-way, double solenoid/bistable, 5/2-way, double solenoid/bistable, dominant signal, 5/2-way, single solenoid/monostable
Electrical connection	Plug, via E-box, connection pattern H, horizontal connection, M8x1 A-coded to EN 61076-2-104, 2-pin, 3-pin	Via sub-base	To EN 175301-803, type B, type C	Via F coil, to be ordered separately
Description	<ul style="list-style-type: none"> • Compact universal valve • Connection technology via electrical connection box (E-box) • High flow rate relative to its size • In-line valves can be used as individual valves or manifold valves 	<ul style="list-style-type: none"> • Sub-base valve • For valve terminal VTUG with multi-pin plug, fieldbus interface • Variants to EU Explosion Protection Directive (ATEX) 	<ul style="list-style-type: none"> • Universal valve, sturdy and durable • Low-cost, no limitations with regard to performance • Can be used as individual valves or manifold valves VTUS 	<ul style="list-style-type: none"> • Sturdy and reliable • Poppet valve • All-metal version • Principle with armature tube
→ Page/online	164	164	169	tiger classic

Product overview



Electrically and pneumatically actuated directional control valves >

Application-specific directional control valves

	 Solenoid valves VOFD	 Solenoid valves VOFC	 Solenoid valves MHE2, MHP2, MHA2, MHE3, MHP3, MHA3, MHE4, MHP4, MHA4
Design	Directly actuated poppet valve	Piston spool, piloted poppet valve	Pressure-relieved poppet valve
Valve function	3/2-way, single solenoid, closed, semi-automatic, 3/2-way, single solenoid, closed	3/2-way, single solenoid, closed, 5/2-way, double solenoid, 5/2-way, single solenoid	3/2-way, single solenoid, closed, 3/2-way, single solenoid, open, 5/2-way, single solenoid
Operating pressure	0 ... 12 bar	0 ... 10 bar	-0.9 ... 8 bar
Ambient temperature	-50 ... 60°C	-25 ... 60°C	-5 ... 60°C
Pneumatic connection 1	NAMUR port pattern, 1/4 NPT, G1/4, 1/2 NPT, G1/2	NAMUR port pattern, 1/4 NPT, 1/2 NPT, G1/2, G1/4	Sub-base, G1/4, G1/8, M7, QS-4, QS-6, QS-8
Standard nominal flow rate	52 ... 1900 l/min	766 ... 2686 l/min	90 ... 400 l/min
Description	<ul style="list-style-type: none"> • Suitable for process automation, for applications in chemical and petrochemical plants • Suitable for outdoor use under harsh, dusty ambient conditions • Especially suitable for quarter turn actuators thanks to NAMUR flange pattern • Variants to EU Explosion Protection Directive (ATEX) • Variants with TÜV approval up to SIL3 acc. to IEC 61508 	<ul style="list-style-type: none"> • Suitable for process automation, for applications in chemical and petrochemical plants • Suitable for outdoor use under harsh, dusty ambient conditions • Especially suitable for quarter turn actuators thanks to NAMUR flange pattern • Valve can switch between internal and external pilot air • Variants to EU Explosion Protection Directive (ATEX) • Variants with TÜV approval up to SIL3 acc. to IEC 61508 	<ul style="list-style-type: none"> • Directly actuated poppet valve • Fast-switching valve: switching times down to 2 ms • Direct mounting, individual sub-base, manifold assembly • Manifold block for 2 ... 10 valves
→ Page/online	vofd	vofc	mh2





Electrically and pneumatically actuated directional control valves >

Application-specific directional control valves

	 Fast-switching valves MHJ9, MHJ10	 Pilot valves VOFX
Design	Poppet valve without spring return	Directly actuated poppet valve
Valve function	2/2-way, single solenoid, closed	3/2-way, single solenoid, closed
Operating pressure	0.5 ... 8 bar	-0.9 ... 8 bar
Ambient temperature	-5 ... 60°C	-10 ... 50°C
Pneumatic connection 1	Sub-base, QS-4, QS-6	G1/8
Standard nominal flow rate	50 ... 160 l/min	50 l/min
Description	<ul style="list-style-type: none"> • Directly actuated poppet valve • Identical basic valves for direct mounting or manifold installation • Individual valve with integrated QS fitting • Switching frequencies up to 1000 Hz • Very good reproducibility • MHJ9: Valve manifold assembly with individual outputs or with air nozzle output • MHJ9: Electrical connection via connecting cable MHJ9-KMH with integrated control electronics • MHJ10: Valve manifold assembly with individual outputs • MHJ10: Electrical connection via moulded-in cable, control electronics included in the valve 	<ul style="list-style-type: none"> • For angle seat valves VZXF and VZXA • For use wherever valve terminals are not economically or technically viable • Manual override, detenting
→ Page/online	mhj9	343



Manually actuated directional control valves >

Swivel lever valves

	 Hand lever valves VHEF-H	 Hand lever valves VHEF, NPT thread	 Hand lever valves VHER	 Hand lever valves VHER, NPT thread
Valve function	3/2-way bistable, 3/2-way open/closed monostable, 5/2-way bistable, 5/2-way monostable, 5/3-way exhausted, 5/3-way closed	3/2-way bistable, 3/2-way open/closed monostable, 5/2-way bistable, 5/2-way monostable, 5/3-way exhausted, 5/3-way closed	4/3-way pressurised, 4/3-way exhausted, 4/3-way closed	4/3-way exhausted, 4/3-way closed
Type of control	Direct	Direct	Direct	Direct
Standard nominal flow rate	530 ... 1200 l/min	530 ... 1200 l/min	170 ... 3800 l/min	600 ... 3800 l/min
Pneumatic working port	G1/4, G1/8	NPT1/4, NPT1/4-18, NPT1/8, NPT1/8-27	G1/2, G1/4, G1/8, M5	NPT1/2-14, NPT1/4-18, NPT1/8-27
Operating pressure	-0.95 ... 10 bar	-0.95 ... 10 bar	0 ... 10 bar	0 ... 10 bar
Description	<ul style="list-style-type: none"> • With hand lever on the side or on top • Durable thanks to tried-and-tested piston spool and disc seat valve technology • Sturdy metal housing • Attractively priced • Ergonomic and safe operation • Low actuating forces • Modern design • Reverse operation possible 	<ul style="list-style-type: none"> • With hand lever on the side or on top • Durable thanks to tried-and-tested piston spool and disc seat valve technology • Sturdy metal housing • Attractively priced • Ergonomic and safe operation • Low actuating forces • Modern design • Reverse operation possible 	<ul style="list-style-type: none"> • Lever in metal or polymer design • Front panel mounting, through-holes or mounting holes 	<ul style="list-style-type: none"> • Lever in metal or polymer design • Front panel mounting, through or mounting holes
→ Page/online	173	173	175	175

Manually actuated directional control valves >



Pushbutton valves

	 Pushbutton valves VHEF-P	 Pushbutton valves VHEF-P, NPT thread
Valve function	3/2-way bistable, 3/2-way open/closed monostable, 5/2-way bistable, 5/2-way monostable	3/2-way bistable, 3/2-way open/closed monostable, 5/2-way bistable, 5/2-way monostable
Type of control	Direct, pilot-controlled	Direct, pilot-controlled
Standard nominal flow rate	750 ... 1200 l/min	750 ... 1200 l/min
Pneumatic working port	G1/4, G1/8	NPT1/4-18, NPT1/8-27
Operating pressure	-0.95 ... 10 bar	-0.95 ... 10 bar
Description	<ul style="list-style-type: none"> • With button switch • Durable thanks to tried-and-tested piston spool and disc seat valve technology • Sturdy metal housing • Attractively priced • Ergonomic and safe operation • Low actuating forces • Modern design • Reverse operation possible 	<ul style="list-style-type: none"> • With button switch • Durable thanks to tried-and-tested piston spool and disc seat valve technology • Sturdy metal housing • Attractively priced • Ergonomic and safe operation • Low actuating forces • Modern design • Reverse operation possible
→ Page/online	177	177

Product overview



Manually actuated directional control valves >

Finger lever valves

	 Finger lever valves VHEF-L	 Finger lever valves VHEF-L, NPT thread
Valve function	3/2-way open/closed monostable, 5/2-way monostable	3/2-way open/closed monostable, 5/2-way monostable
Type of control	Direct	Direct
Standard nominal flow rate	750 ... 1200 l/min	750 ... 1200 l/min
Pneumatic working port	G1/4, G1/8	NPT1/4-18, NPT1/8-27
Operating pressure	-0.95 ... 10 bar	-0.95 ... 10 bar
Description	<ul style="list-style-type: none"> • With finger lever • Durable thanks to tried-and-tested piston spool and disc seat valve technology • Sturdy metal housing • Attractively priced • Ergonomic and safe operation • Low actuating forces • Modern design • Reverse operation possible 	<ul style="list-style-type: none"> • With finger lever • Durable thanks to tried-and-tested piston spool and disc seat valve technology • Sturdy metal housing • Attractively priced • Ergonomic and safe operation • Low actuating forces • Modern design • Reverse operation possible
→ Page/online	179	179



Manually actuated directional control valves >

Selector switches

	 Selector valves VHEF-ES	 Selector valves VHEF-ES, NPT thread
Valve function	3/2-way bistable, 3/2-way open/closed monostable, 5/2-way bistable, 5/2-way monostable, 5/3-way exhausted, 5/3-way closed	3/2-way bistable, 3/2-way open/closed monostable, 5/2-way bistable, 5/2-way monostable, 5/3-way exhausted, 5/3-way closed
Type of control	Direct	Direct
Standard nominal flow rate	530 ... 1200 l/min	530 ... 1200 l/min
Pneumatic working port	G1/4, G1/8	NPT1/4, NPT1/4-18, NPT1/8, NPT1/8-27
Operating pressure	-0.95 ... 10 bar	-0.95 ... 10 bar
Description	<ul style="list-style-type: none"> • With selector switch on the side or on top • Durable thanks to tried-and-tested piston spool and disc seat valve technology • Sturdy metal housing • Attractively priced • Ergonomic and safe operation • Low actuating forces • Modern design • Reverse operation possible 	<ul style="list-style-type: none"> • With selector switch on the side or on top • Durable thanks to tried-and-tested piston spool and disc seat valve technology • Sturdy metal housing • Attractively priced • Ergonomic and safe operation • Low actuating forces • Modern design • Reverse operation possible
→ Page/online	181	181



Mechanically actuated directional control valves >

Stem actuated valves

	 Stem actuated valves VMEF-S	 Stem actuated valves VMEF-S, NPT thread
Valve function	3/2-way closed monostable, 5/2-way monostable	5/2-way monostable
Type of control	Direct, pilot-controlled	Piloted
Standard nominal flow rate	750 ... 1200 l/min	750 ... 1200 l/min
Pneumatic working port	G1/4, G1/8	NPT1/4-18, NPT1/8-27
Operating pressure	-0.95 ... 10 bar	-0.95 ... 10 bar
Description	<ul style="list-style-type: none"> • Durable thanks to tried-and-tested piston spool and disc seat valve technology • Sturdy metal housing • Outstanding pneumatic performance • Attractively priced • Ergonomic and safe operation • Low actuating forces • Modern design • Reverse operation possible 	<ul style="list-style-type: none"> • Durable thanks to tried-and-tested piston spool and disc seat valve technology • Sturdy metal housing • Outstanding pneumatic performance • Attractively priced • Ergonomic and safe operation • Low actuating forces • Modern design • Reverse operation possible
→ Page/online	183	183

Mechanically actuated directional control valves >



Roller lever valves

	 Roller lever valves VMEF-R	 Roller lever valves VMEF-R, NPT thread
Valve function	3/2-way monostable, 5/2-way monostable	3/2-way monostable, 5/2-way monostable
Type of control	Direct	Direct
Standard nominal flow rate	750 ... 1200 l/min	750 ... 1200 l/min
Pneumatic working port	G1/4, G1/8	NPT1/4, NPT1/8
Operating pressure	-0.95 ... 10 bar	-0.95 ... 10 bar
Description	<ul style="list-style-type: none"> • Durable thanks to tried-and-tested piston spool and disc seat valve technology • Sturdy metal housing • Outstanding pneumatic performance • Attractively priced • Ergonomic and safe operation • Low actuating forces • Modern design • Reverse operation possible 	<ul style="list-style-type: none"> • Durable thanks to tried-and-tested piston spool and disc seat valve technology • Sturdy metal housing • Outstanding pneumatic performance • Attractively priced • Ergonomic and safe operation • Low actuating forces • Modern design • Reverse operation possible
→ Page/online	185	185

Product overview

Mechanically actuated directional control valves >

Roller lever valves

	 Roller lever valves VMEF-K	 Roller lever valves VMEF-K, NPT thread
Valve function	3/2-way monostable, 5/2-way monostable	3/2-way monostable, 5/2-way monostable
Type of control	Direct	Direct
Standard nominal flow rate	750 ... 1200 l/min	750 ... 1200 l/min
Pneumatic working port	G1/4, G1/8	NPT1/4, NPT1/8
Operating pressure	-0.95 ... 10 bar	-0.95 ... 10 bar
Description	<ul style="list-style-type: none"> • Durable thanks to tried-and-tested piston spool and disc seat valve technology • Sturdy metal housing • Outstanding pneumatic performance • Attractively priced • Ergonomic and safe operation • Low actuating forces • Modern design • Reverse operation possible 	<ul style="list-style-type: none"> • Durable thanks to tried-and-tested piston spool and disc seat valve technology • Sturdy metal housing • Outstanding pneumatic performance • Attractively priced • Ergonomic and safe operation • Low actuating forces • Modern design • Reverse operation possible
→ Page/online	187	187



Shut-off valves >

Check valves and quick exhaust valves

	 Check valves, piloted HGL
Pneumatic connection 1	G1/2, G1/4, G1/8, G3/8, M5, QS-10, QS-12, QS-4, QS-6, QS-8
Standard nominal flow rate 1 → 2 from 6 to 5 bar	130 ... 1600 l/min
Operating pressure	0.5 ... 10 bar
Description	<ul style="list-style-type: none"> • Valve function: piloted non-return function • Pneumatically piloted • Screw-in with male thread • Pilot air connection: M5, G1/8, G1/4, G3/8, QS-4 • Manually actuated exhaust possible with separate accessories
→ Page/online	189



Shut-off valves >

Shut-off valves and ball valves

	 Hand slide valves VBOH	 Ball valves QH-QS, QHS-QS	 Ball valves QH
Valve function	3/2-way, bistable	2/2-way, bistable	2/2-way, bistable
Pneumatic connection 1	G1/2, G1/4, G1/8, G3/4, G3/8, M5	QS-4, QS-6, R1/8	G1, G1 1/2, G1/2, G1/4, G3/4, G3/8
Standard nominal flow rate	236 ... 7691 l/min	148 ... 560 l/min	3400 ... 84000 l/min
Operating pressure	-0.95 ... 12 bar	-1 ... 10 bar	
Description	<ul style="list-style-type: none"> Used as a shut-off function for pressurising and exhausting compressed air systems, e.g. upstream of service unit combinations, for air guns and also for exhausting pneumatic cylinders Non-overlapping, so no pressure losses when switching Minimal installation effort 	<ul style="list-style-type: none"> Shut-off valve, manually operated In-line installation, can be screwed in, bulk-head fitting Variants: thread at both ends, push-in connector at both ends, thread/push-in connector 	<ul style="list-style-type: none"> Shut-off valve, manually operated In-line installation Female thread at both ends With hand lever Pipe thread to ISO 2281
→ Page/online	190	qh	191

Flow control valves >



One-way flow control valves

	 One-way flow control valves GRLA, GRLZ	 One-way flow control valves VFOF
Valve function	Exhaust air one-way flow control function, one-way flow control function, supply air one-way flow control function	Exhaust air one-way flow control function
Pneumatic connection 1	Male thread G1/4, G1/2, G1/4, G1/8, G3/4, G3/8, M3, M5, PK-3, PK-3 with union nut, PK-4, PK-4 with union nut, PK-6 with union nut, QS-10, QS-12, QS-3, QS-4, QS-6, QS-8	QS-6, QS-8
Standard nominal flow rate in flow control direction	0 ... 4320 l/min	240 ... 590 l/min
Adjusting element	Knurled screw, slotted head screw, internal hex	Internal hex
Description	<ul style="list-style-type: none"> Functional combination of one-way flow control valve and piloted check valve Flow control valve, flow control at one end Polymer, metal or stainless steel design Standard, mini, in-line variants with different flow rates Connections: thread at both ends, push-in connector at both ends, thread/push-in connector 	<ul style="list-style-type: none"> Functional combination of one-way flow control valve and piloted check valve High flow rate Can be rotated horizontally through 360° when mounted Compact and can be operated from the side
→ Page/online	192	vfof



Product overview

Proportional valves >



Pressure regulators

	 Proportional pressure regulators VPPE	 Proportional pressure regulators VPPM
Valve function	3-way proportional pressure regulator, 3-way proportional pressure regulator, closed	3-way proportional pressure regulator
Pneumatic connection 1	G1/8	Sub-base, G1/2, G1/4, G1/8
Pressure regulation range	0.02 ... 10 bar	0.02 ... 10 bar
Operating pressure	8 bar	
Standard nominal flow rate	310 ... 1250 l/min	380 ... 7000 l/min
Description	<ul style="list-style-type: none"> • Piloted pressure regulator • Setpoint input as analogue voltage signal (0 ... 10 V) • Electrical connection via M12x1 plug, 4 or 5-pin • Optionally with setpoint module • Variant with display with three retrievable presets and digital controller electronics • For simple control tasks 	<ul style="list-style-type: none"> • Piloted pressure regulator • Multi-sensor control (cascade control) • Three default presets for fast commissioning • Integration in valve terminal MPA • User interface with LED displays, LCD display, adjustment/selection buttons • Integrated pressure sensor • Electrical connection via plug, round design, 8-pin, M12 or terminal linking
→ Page/online	vppe	vppm





Solenoid actuated process and media valves

	 Solenoid valves VZWD	 Solenoid valves VZWF	 Solenoid valves VZWM
Design	Directly actuated poppet valve	Diaphragm valve, force pilot operated	Diaphragm valve, servo-controlled
Actuation type	Electrical	Electrical	Electrical
Nominal width	1 ... 6 mm	13.5 ... 50 mm	13 ... 50 mm
Flow rate Kv	0.06 ... 0.4 m³/h	1.8 ... 28 m³/h	1.6 ... 39 m³/h
Temperature of medium	-10 ... 80°C	-10 ... 80°C	-10 ... 60°C
Medium pressure	0 ... 90 bar	0 ... 10 bar	
Process valve connection	1/4 NPT, 1/8 NPT, G1/4, G1/8, NPT1/4	1 NPT, 1 1/2 NPT, 1 1/4 NPT, 1/2 NPT, 1/4 NPT, 2 NPT, 3/4 NPT, 3/8 NPT, G1, G1 1/2, G1 1/4, G1/2, G1/4, G2, G3/4, G3/8, NPT1, NPT1 1/2, NPT1 1/4, NPT1/2, NPT1/4, NPT2, NPT3/4, NPT3/8	G1, G1 1/2, G1 1/4, G1/2, G1/4, G2, G3/4, G3/8
Description	<ul style="list-style-type: none"> • Large pressure range • Directly actuated poppet valve • No pressure difference required • Can also be used in vacuum technology 	<ul style="list-style-type: none"> • High flow rates • Large nominal diameters with relatively small solenoids • No pressure difference required • Can also be used in vacuum technology 	<ul style="list-style-type: none"> • Brass or stainless steel casting design • Electrical connection via solenoid armature tube • Wide range of coils • Coil can be ordered separately
→ Page/online	346	348	350

Solenoid actuated process and media valves



	 Reverse jet pulse valves VZWE-E, VZWE-F	 Solenoid valves VZWP
Design	Angled version, straight version with flange, diaphragm valve	Piloted piston poppet valve
Actuation type	Electrical	Electrical
Nominal width	20 ... 76 mm	13 ... 25 mm
Flow rate Kv	15 ... 210 m ³ /h	1.5 ... 11.5 m ³ /h
Temperature of medium		-10 ... 80°C
Medium pressure	0.35 ... 8 bar	0.5 ... 40 bar
Process valve connection		1 NPT, 1/2 NPT, 1/4 NPT, 3/4 NPT, 3/8 NPT, G1, G1/2, G1/4, G3/4, G3/8
Description	<ul style="list-style-type: none"> • High flow rates • For mechanically cleaning filters and dust filter systems • Fast opening and closing times • Sturdy pilot system 	<ul style="list-style-type: none"> • For all applications with a differential pressure of min. 0.5 bar • For high pressures and high flow rates with relatively small solenoids • For controlling gaseous and liquid media in open circuits
→ Page/online	vzwe	vzwp

Pneumatically and mechanically actuated process and media valves



	 Ball valves VZBD	 Ball valves VZBE	 Ball valves VZBF	 Ball valves VZBC
Design	2-way ball valve	2-way ball valve, 2-way ball valve with hand lever, 3-way ball valve, L-shaped hole, T-shaped hole	2-way ball valve	2-way ball valve
Valve function	2/2	2/2, 3/2	2/2	2/2
Actuation type	Mechanical	Mechanical	Mechanical	Mechanical
Nominal width				
Nominal width DN	15, 20, 25, 32, 40, 50, 65, 80, 100	8, 10, 15, 20, 25, 32, 40, 50, 65, 80, 100	15, 20, 25, 32, 40, 50, 65, 80, 100, 150, 200	15, 20, 25, 32, 40, 50, 65, 80, 100
Process valve connection	Clamp to ASME-BPE, clamp to DIN 32676 series B, weld-on end to ASME-BPE, weld-on end to ISO 1127	1 NPT, 1 1/2 NPT, 1 1/4 NPT, 1/2 NPT, 1/4 NPT, 2 NPT, 2 1/2 NPT, 3 NPT, 3/4 NPT, 3/8 NPT, 4 NPT, weld-on end to ASME B16.11	Flange to ANSI B16.5 class 150	Ring housing with threaded flange
Flow rate Kv	3.5 ... 436.3 m ³ /h	5 ... 435.2 m ³ /h	8.5 ... 2078.3 m ³ /h	19.4 ... 1414 m ³ /h
Temperature of medium	-20 ... 200°C	-20 ... 200°C	-20 ... 200°C	
Medium pressure				-10 ... 200°C
Process valve PN nominal pressure	16	63	20	16, 40
Description	<ul style="list-style-type: none"> • Electro-polished surfaces SFV4 • PTFE seal with minimal dead space • The powerful ball valve for the pharmaceutical and cosmetic industries • FDA-compliant seal to FDA 21 CFR 177.1550 	<ul style="list-style-type: none"> • 2-way manual, with lockable hand lever • 2-way and 3-way with top flange to ISO 5211, optionally with lockable hand lever • Stainless steel design • Pipe thread to ASME B1.20.1 or welded end to ASME B16.11 • Optionally with pre-assembled hand lever 	<ul style="list-style-type: none"> • Flanged connections to ANSI B 16.5. class 150 • Static discharge assured • API 607 Fire Safe approval • Stainless steel design • Easy to service • Optionally with pre-assembled hand lever 	<ul style="list-style-type: none"> • Automatable 2-way compact flanged ball valve • Stainless steel design • Short installed length • Blow-out proof shaft • Manual operation possible using hand lever • Flange to DIN 1092-1 • Mounting flange to ISO 5211 • Use in zone 1, 21, 2, 22
→ Page/online	vzbd	vzbe	vzbf	vzbc

Product overview

Pneumatically and mechanically actuated process and media valves

	 Ball valves VZBA	 Angle seat valves VZXF	 Angle seat valves VZXA
Design	2-way ball valve, 3-way ball valve, L-shaped hole, T-shaped hole	Piston actuator with poppet valve	Poppet valve with piston actuator, poppet valve with diaphragm actuator
Valve function	2/2, 3/2	2/2-way, monostable, closed	2/2
Actuation type	Mechanical	Pneumatic	Pneumatic
Nominal width		12 ... 45 mm	
Nominal width DN	8, 10, 15, 20, 25, 32, 40, 50, 65, 80, 100	12, 13, 16, 18, 23, 24, 29, 31, 35, 43, 45	13, 20, 25, 32, 40, 50, 65
Process valve connection	Weld-on ends/weld-on ends, Rp1, Rp1 1/2, Rp1 1/4, Rp1/2, Rp1/4, Rp2, Rp2 1/2, Rp3, Rp3/4, Rp3/8, Rp4		
Flow rate Kv	7 ... 1414 m ³ /h	3.3 ... 43 m ³ /h	6 ... 77.9 m ³ /h
Temperature of medium	-10 ... 200°C	-40 ... 200°C	-30 ... 200°C
Medium pressure		-0.9 ... 40 bar	-0.9 ... 30 bar
Process valve PN nominal pressure	63	16, 40	25, 40
Description	<ul style="list-style-type: none"> • Automatable 2-way or 3-way ball valve • Stainless steel design • Blow-out proof shaft • Manual operation possible using hand lever • Connecting thread to EN 10226-1 • Mounting flange to ISO 5211 • Use in zone 1, 21, 2, 22 	<ul style="list-style-type: none"> • Sturdy design • Stainless steel and gunmetal (red brass) process valves with stainless steel, brass or aluminium actuators • Safety position "closing" • Different actuator sizes and housing materials • Selection of different seat and shaft seals • For liquids, gases and other easily contaminated media • Easy-to-clean design 	<ul style="list-style-type: none"> • Highly flexible, extremely high flow rates • Long service life • Stainless steel or Ecobrass process valves with stainless steel or polymer drives • Modular design • Hygienic design, insensitive to dirt • Quick and easy maintenance • Simple and sturdy: an ideal choice for virtually all media with a viscosity of up to 600 mm²/s • High chemical and thermal resistance • Variants to EU Explosion Protection Directive (ATEX)
online: →	340	vzxf	342

Pneumatically and mechanically actuated process and media valves

	 Pinch valves VZQA	 Ball valve actuator units VZBM	 Ball valve actuator units VZBA
Design	Pinch valve, pneumatically actuated	2-way ball valve, 3-way ball valve, quarter turn actuator	2-way ball valve, 3-way ball valve, L-shaped hole, quarter turn actuator, T-shaped hole
Valve function	2/2-way, monostable, closed, 2/2-way, monostable, open		
Actuation type	Pneumatic	Pneumatic	Pneumatic
Nominal width			
Nominal width DN	6, 15, 25	8, 10, 15, 20, 25, 32, 40, 50	8, 10, 15, 20, 25, 32, 40, 50, 65, 80, 100
Process valve connection	Clamp to ASME-BPE type A, clamp to ASME-BPE type B, clamp to DIN 32676 series A, 1 NPT, 1/2 NPT, 1/4 NPT, G1, G1/2, G1/4	Rp1, Rp1 1/2, Rp1 1/4, Rp1/2, Rp1/4, Rp2, Rp3/4, Rp3/8	Weld-on ends/weld-on ends, Rp1, Rp1 1/2, Rp1 1/4, Rp1/2, Rp1/4, Rp2, Rp2 1/2, Rp3, Rp3/4, Rp3/8, Rp4
Flow rate Kv	0.7 ... 18 m ³ /h	5.9 ... 243 m ³ /h	7 ... 1414 m ³ /h
Temperature of medium	-15 ... 150°C	-20 ... 130°C	-10 ... 200°C
Medium pressure	0 ... 6 bar		
Process valve PN nominal pressure	10	25, 40	63
Description	<ul style="list-style-type: none"> • Modular design • Quick and easy replacement of the diaphragm • For critical, abrasive and viscous media • Easy-to-clean design • Flow direction is freely selectable • Versions with end-position sensing 	<ul style="list-style-type: none"> • Ball valve actuator unit with double-acting or single-acting quarter turn actuator DFPD • Brass ball valve • 2-way ball valve actuator unit with pipe thread to EN 10226-1 • 3-way ball valve actuator unit with L-shaped hole and pipe thread to EN 10226-1 • 3-way ball valve actuator unit with T-shaped hole and pipe thread to EN 10226-1 • Flow is fully opened or closed in both directions 	<ul style="list-style-type: none"> • Ball valve actuator unit with double-acting or single-acting quarter turn actuator DAPS • Stainless steel ball valve • NAMUR connection pattern for solenoid valves/limit switch attachments to VDI/VDE 3845 • Flow is fully opened or closed in both directions • Use in zone 1, 21, 2, 22
→ Page/online	344	352	354

Product overview

Customised components – for your specific requirements

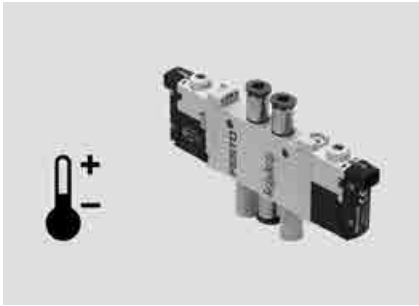

Valves with customised designs

Can't find the valve you need in our catalogue?

We can offer you customised components that are tailored to your specific requirements.

Common product modifications:

- Coatings for special ambient conditions
- Customised cables: length, pin allocation, pre-assembled with plug
- Modified actuating elements
- Modified connecting thread
- Modified valve sub-bases

Many additional variants are possible.

Ask your Festo sales engineer, who will be happy to help:

→ www.festo.com/contact



- Connection G1/4, 1/4 NPT
- Flow rate 900 ... 1350 l/min
- Voltage 12, 24, 48 V DC, 24, 48, 120, 230 V AC
- Namur connection pattern to VDE/VDI 3845
- Solenoid actuated, piloted
- Mechanical spring return
- Can be converted from 5/2- to 3/2-way function
- Selected types in accordance with ATEX directive for potentially explosive atmospheres
→ www.festo.com/ex

Order code – Basic design

001	002	003	004	005	006	007	008	009	010	011	012
VSNC	F					D					

001	Type
VSNC	Solenoid valve
002	Valve type
F	Flanged valve
003	Design principle
–	Piston spool
004	Additional function
–	None
C	Convertible valve function
005	Valve function
M52	5/2-way valve, single solenoid
B52	5/2-way valve, double solenoid
P53C	5/3-way valve, mid-position closed
P53E	5/3-way valve, mid-position exhausted
P53U	5/3-way valve, mid-position pressurised
006	Reset method for single solenoid valves
–	None (for double pilot valves)
M	Mechanical spring

007	Manual override
D	Non-detenting, detenting
008	Pneumatic connection
G14	G1/4
N14	1/4NPT
009	Exhaust
–	No fitting
010	Interface to valve controller
F8	With armature tube 8 mm long
FN	With armature tube 9 mm long
011	Nominal operating voltage
–	None
1	24V DC
012	Electrical connection
–	None
A1	Connecting cable type A, to EN 175301
B2	Connecting cable type B, industry standard

Legend: Mandatory entry Optional entry

Product options

T	Poppet valve	Exhaust	Nominal operating voltage	Electrical connection
M32C	3/2-way valve, normally closed	QN With fitting U Silencer	12 V DC, 24 V AC/50-60 Hz, 48 V AC/50-60 Hz, 110 V AC/50-60 Hz, 230 V AC/50-60 Hz	C3 Cable, 3 m K11 Cable with insulating conduit connection
H	Manual override, non-detenting, resetting	Pneumatic connection Push-in connector 6 ... 10 mm	Ignition protection type A Intrinsically safe M Encapsulation N Non-sparking	Degree of protection for electrics S8 IP67
S	Manual override, covered	Push-in connector 1/4 ... 3/8		EU certification EX2 II 3GD EX4 II 2GD
				Certification U4 Class 1 Div 1 to NEC 500

Electrically and pneumatically actuated directional control valves > Standards-based directional control valves >

Solenoid valves VSNC, NAMUR

Ordering – Product options

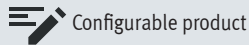

This product and all its product options can be ordered online via the configurator:

→ www.festo.com/catalogue/...

Enter the part number or the type.

Part no. Type
8026033 VSNC

Ordering – Basic design

Without solenoid coil, convertible valve function		
	Type	Part no.
008 Pneumatic connection		
012 Without electrical connection		
005 5/2-way valve, single solenoid		
010 With armature tube 8 mm long		
G1/4	VSNC-FC-M52-MD-G14-F8	577257
1/4NPT	VSNC-FC-M52-MD-N14-F8	577262
010 With armature tube 9 mm long		
G1/4	VSNC-FC-M52-MD-G14-FN	577267
1/4NPT	VSNC-FC-M52-MD-N14-FN	577272

With 24 V DC solenoid coil, without plug socket, convertible valve function		
	Type	Part no.
008 Pneumatic connection		
012 Electrical connection		
005 5/2-way valve, single solenoid		
010 With armature tube 8 mm long		
G1/4	VSNC-FC-M52-MD-G14-F8-1B2	577295
Connection pattern type B, industry standard		
G1/4	VSNC-FC-M52-MD-G14-F8-1A1	8074945
Plug pattern type A, to EN 175301		

Without solenoid coil, without additional function		
	Type	Part no.
008 Pneumatic connection		
012 Without electrical connection		
005 5/2-way valve, double solenoid		
010 With armature tube 8 mm long		
G1/4	VSNC-F-B52-D-G14-F8	577258
1/4NPT	VSNC-F-B52-D-N14-F8	577263
010 With armature tube 9 mm long		
G1/4	VSNC-F-B52-D-G14-FN	577268
1/4NPT	VSNC-F-B52-D-N14-FN	577273
005 5/3-way valve, mid-position closed		
010 With armature tube 8 mm long		
G1/4	VSNC-F-P53C-MD-G14-F8	577259
1/4NPT	VSNC-F-P53C-MD-N14-F8	577264
010 With armature tube 9 mm long		
G1/4	VSNC-F-P53C-MD-G14-FN	577269
1/4NPT	VSNC-F-P53C-MD-N14-FN	577274
005 5/3-way valve, mid-position exhausted		
010 With armature tube 8 mm long		
G1/4	VSNC-F-P53U-MD-G14-F8	577260
1/4NPT	VSNC-F-P53U-MD-N14-F8	577265
010 With armature tube 9 mm long		
G1/4	VSNC-F-P53U-MD-G14-FN	577270
1/4NPT	VSNC-F-P53U-MD-N14-FN	577275
005 5/3-way valve, mid-position pressurised		
010 With armature tube 8 mm long		
G1/4	VSNC-F-P53E-MD-G14-F8	577261
1/4NPT	VSNC-F-P53E-MD-N14-F8	577266
010 With armature tube 9 mm long		
G1/4	VSNC-F-P53E-MD-G14-FN	577271
1/4NPT	VSNC-F-P53E-MD-N14-FN	577276

Accessories

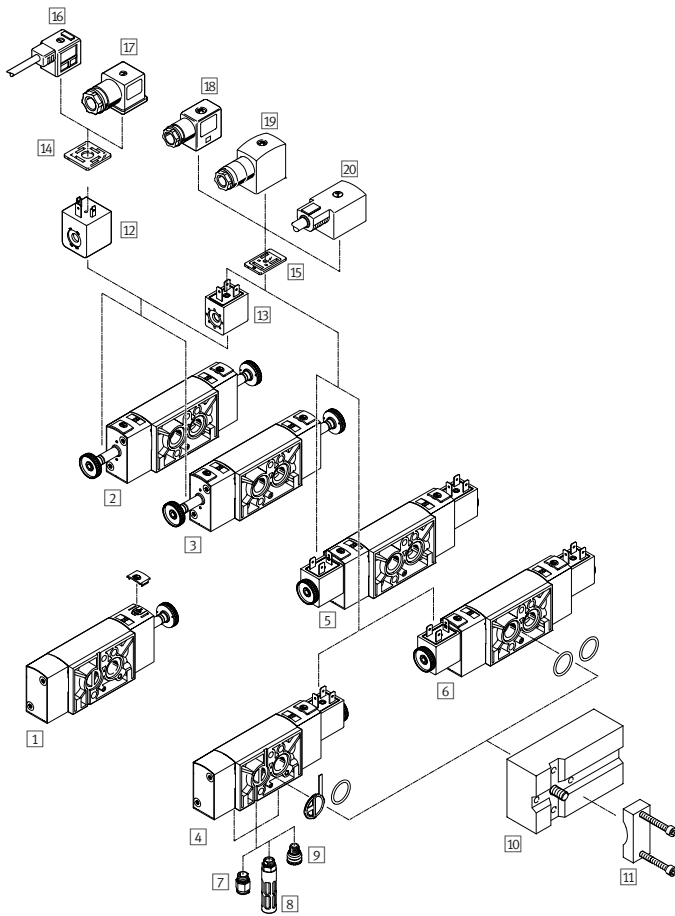

Solenoid valves VSNC...-F8

- 1 3/2-way and 5/2-way valve, single solenoid → 158
- 2 5/2-way valve, double solenoid → vsnc
- 3 5/3-way valve, single solenoid, normally open, closed or exhausted → vsnc
- 4 3/2-way and 5/2-way valve, single solenoid, with solenoid coil → 158
- 5 5/2-way valve, double solenoid, with solenoid coil → 158
- 6 5/3-way valve, single solenoid, normally open, closed or exhausted, with solenoid coil → 158
- 7 Push-in fitting QS → 293
- 8 Silencer U → 317
- 9 Exhaust protection VABD-D3-SN-G14 → vsnc
- 10 Connection kit VABF-S7-S-G14 → vsnc
- 11 Mounting bracket VAME-S7-Y → vsnc

- 12 Solenoid coil VACF-A → 159
- 13 Solenoid coil VACF-B → 159
- 14 Illuminating seal MC-LD → vsnc
- 15 Illuminating seal MF-LD → vsnc
- 16 Connecting cable KMC → vsnc
- 17 Plug socket MSSD-C → vsnc
- 18 Plug socket MSSD-F → vsnc
- 19 Plug socket MSSD-F-S → vsnc
- 20 Connecting cable KMF → kmf

For armature tube 8 mm

12/13 Solenoid coil VACF for solenoid valve VSNC-FC-M52-MD-G14-F8			
Description	Type	Part no.	
Connection pattern to industry standard, type B			
	12 V DC; 3,4 W	VACF-B-B2-5	8030801
	24 V DC; 3,3 W	VACF-B-B2-1	8030802
	48 V DC; 3,4 W	VACF-B-B2-7	8030803
	24 V AC; 50/60 Hz	VACF-B-B2-1A	8030804
	48 V AC; 50/60 Hz	VACF-B-B2-7A	8030805
	110/120 V AC; 50/60 Hz	VACF-B-B2-16B	8030806
	230/240 V AC; 50/60 Hz	VACF-B-B2-3W	8030808

12/13 Solenoid coil VACF for solenoid valve VSNC-FC-M52-MD-G14-F8			
Description	Type	Part no.	
Connection pattern to DIN EN 175301-803, type A			
	12 V DC; 2,8 W	VACF-A-A1-5	8030821
	24 V DC; 2,6 W	VACF-A-A1-1	8030822
	48 V DC; 2,8 W	VACF-A-A1-7	8030823
	24 V AC; 50/60 Hz	VACF-A-A1-1A	8030824
	48 V AC; 50/60 Hz	VACF-A-A1-7A	8030825
	110/120 V AC; 50/60 Hz	VACF-A-A1-16B	8030826
	230/240 V AC; 50/60 Hz	VACF-A-A1-3W	8030828

For armature tube 9 mm

Solenoid coil VACN-N

Description	Type	Part no.	
Type of ignition protection: intrinsically safe Ex ia			
	28 V	VACN-N-A1-1-EX4-A	8029139
	Type of ignition protection: non-sparking Ex nA		
	24 V DC; 2,1 W	VACN-N-A1-1-EX2-N	8029136
	110 V AC; 50/60 Hz	VACN-N-A1-16B-EX2-N	8029137
	230 V AC; 50/60 Hz	VACN-N-A1-3A-EX2-N	8029138
Degree of protection IP65 with socket			
	24 V DC; 0,7 W	VACN-N-A1-1	8029144
	110 V AC; 50/60 Hz	VACN-N-A1-16B	8029134
	230 V AC; 50/60 Hz	VACN-N-A1-3A	8029135

Description	Type	Part no.	
Type of ignition protection: encapsulated Ex me			
	230 V AC; 50/60 Hz	VACN-N-K1-3A-EX4-M	8029141
	110 V AC; 50/60 Hz	VACN-N-K1-16B-EX4-M	8029142
	24 V DC; 2,6 W	VACN-N-K1-1-EX4-M	8029143
Type of ignition protection: encapsulated AEx m, Class 1, Div 1 to NEC 500			
	230 V AC; 50 Hz	VACN-N-K11-3A-0.5-U4-M	8029140
	120 V AC; 60 Hz	VACN-N-K11-16B-0.5-U4-M	8029145
	24 V DC; 4,6 W	VACN-N-K11-1-0.5-U4-M	8029146

Electrically and pneumatically actuated directional control valves > Standards-based directional control valves >

Solenoid valves VSVA, to ISO 5599-1

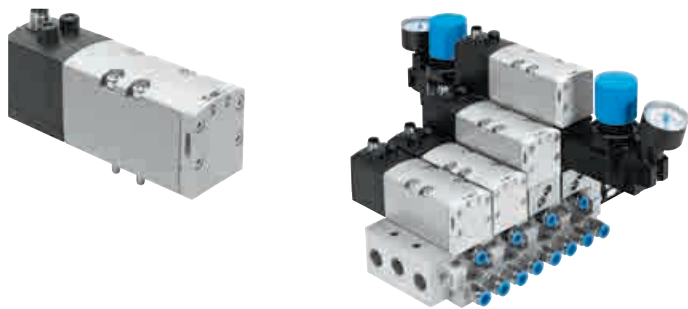

- Sturdy metal design
- Width 42 mm/ISO size 1
- Flow rate up to 1300 l/min
- Solenoid coil with central plug M12, 24 V DC
- Wide range of vertical stacking modules: pressure regulator, flow control, vertical pressure shut-off plate, etc.
- Also available as a valve manifold

Order code

001 002 003 004 005 006 007 008 009 010
VSVA - **B** - - - - **D1** - **1** **R5** **L**

Legend: Mandatory entry Optional entry

001	Type
VSVA	Standards-based valves to ISO 5599-1
002	Valve type
B	Sub-base valve
003	Valve function
M52	5/2-way valve, single solenoid
B52	5/2-way valve, double solenoid
004	Reset method
-	Without, double solenoid valve
A	Pneumatic spring
M	Mechanical spring
005	Pilot air supply
-	Internal

006	Manual override
D	Non-detenting/detenting
H	Non-detenting
007	Pneumatic connection (width)
D1	Width 42 mm/ISO size 1
008	Nominal operating voltage
1	24 VDC
009	Electrical connection
R5	Central plug M12x1
010	Signal status display
L	LED (integrated)

Product options

D52	5/2-way valve, double solenoid with dominant signal at 14	T32U	2x 3/2-way valve, normally open	T32N	2x 3/2-way valve, normally open, reverse operation	Additional function	V	2x 2/2-way valve with vacuum operation
P53C	5/3-way valve, mid-position closed	T32H	2x 3/2-way valve, normally 1x open, 1x closed	T32W	2x 3/2-way valve, normally 1x open, 1x closed, reverse operation		Z	External pilot air supply
P53E	5/3-way valve, mid-position exhausted	T32F	2x 3/2-way valve, normally open, reverse operation	T22C	2x 2/2-way valve, normally closed	D2	Pneumatic connection: width 52 mm/ISO size 2	
P53U	5/3-way valve, mid-position pressurised							
T32C	2x 3/2-way valve, normally closed							

Configurable product

This product and all its product options can be ordered online via the configurator:

→ www.festo.com/catalogue/vsva

Ordering – Basic design

003 Valve function	004 Reset method	007 Pneumatic connection (width)	Type	Part no.
5/2-way valve, single solenoid	Reset method: pneumatic spring	Width 42 mm/ISO size 1	VSVA-B-M52-AD-D1-1R5L	561362
5/2-way valve, single solenoid	Reset method: mechanical spring		VSVA-B-M52-MD-D1-1R5L	561363
5/2-way valve, double pilot	Without, dominance: 1st signal		VSVA-B-B52-D-D1-1R5L	561364

Accessories

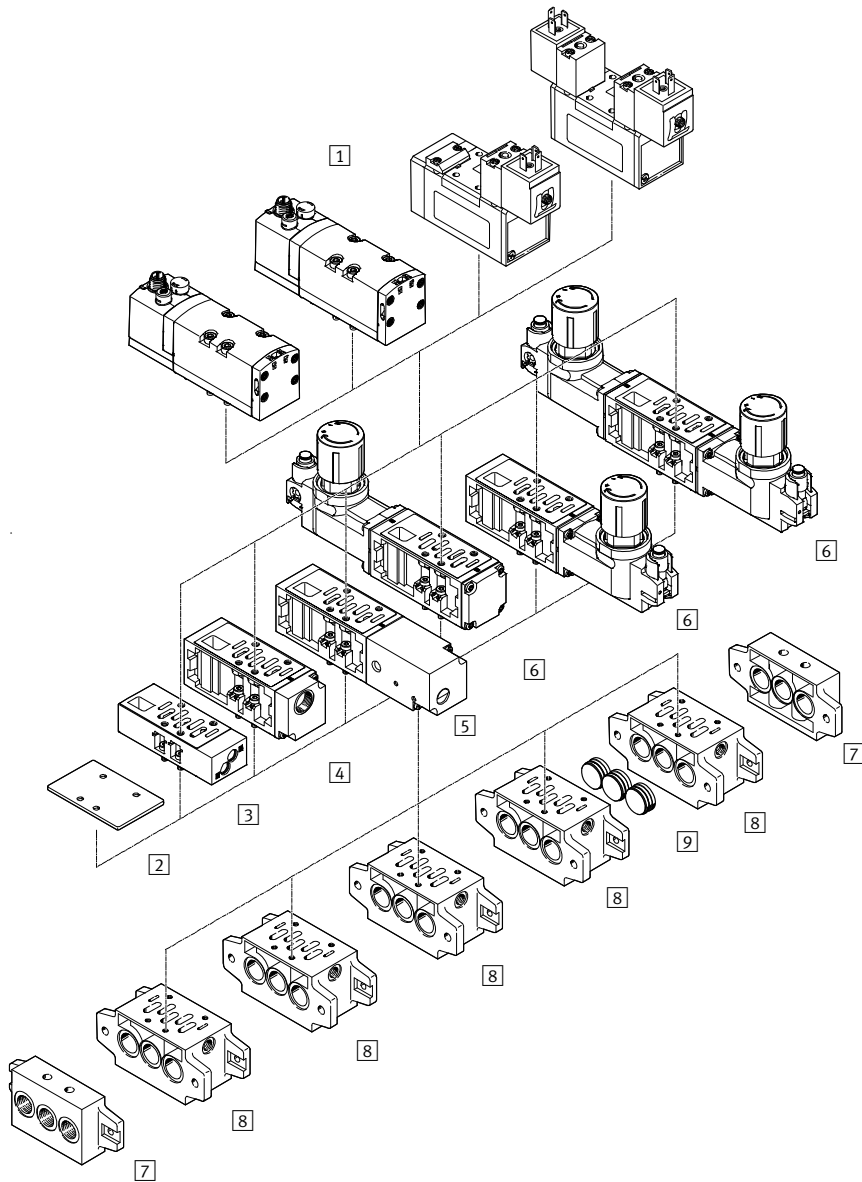

Manifold assembly

- 1 Solenoid valve VSVA with central plug M12, 3-pin
Individual sub-base NAS, NAU
→ 161
- 2 Blanking plate NDV → 161
- 3 Flow control plate
VABF-S1-...-F1B1-C, GRO-ZP-...
→ vsva
- 4 Vertical pressure supply plate
VABF-S1-...-P1A3-G38 → vsva
- 5 Vertical pressure shut-off plate
VABF-S1-...-L1D1-C → vsva
- 6 Regulator plate VABF-S1-...-R...,
LR-ZP-... → vsva
- 7 End plate kit NEV → 161
- 8 Manifold sub-base NAV → 161
- 9 Isolating disc NSC → 161

Manifold sub-base with 90° connections NAVW → 161

1 Individual sub-base NAS, NAU		
For	Type	Part no.
Lateral pneumatic connections		
42 mm	NAS-1/4-1A-ISO	9484
Pneumatic connections underneath		
42 mm	NAU-1/4-1B-ISO	9485
2 Blanking plate NDV		
For	Type	Part no.
42 mm	NDV-1-ISO	9489

7 End plate kit NEV		
For	Type	Part no.
42 mm	NEV-1DA/DB-ISO	10174
8 Manifold sub-base NAV		
For	Type	Part no.
Connections underneath		
42 mm	NAV-1/4-1C-ISO	10173

9 Isolating disc NSC		
For	Type	Part no.
42 mm	NSC-1/4-1-ISO	11550

Manifold sub-base with 90° connections NAVW		
For	Type	Part no.
Connections on the side and underneath		
42 mm	NAVW-1/4-1-ISO	152789

Electrically and pneumatically actuated directional control valves > Standards-based directional control valves >

Solenoid valves VSVA, to ISO 15407-1

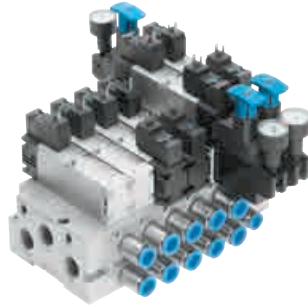

- High-performance valves in a sturdy metal housing
- Width of standards-based valve 18/26 mm, flow rates up to 1400 l/min
- Manifold assembly with mixture of sizes possible
- Electrical connection via round or square plug socket
- Complete and standardised valve range
- Wide range of vertical stacking modules: pressure regulator, flow control valve, vertical pressure shut-off plate, etc.

Order code

001 002 003 004 005 006 007 008 009 010 011

VSVA - B - [] - [] - H - [] - 1 - [] - []

Legend: Mandatory entry Optional entry

001	Type
VSVA	Standards-based valves, to ISO 15407-1
002	Valve type
B	Sub-base valve
003	Valve function
M52	5/2-way valve, single solenoid
B52	5/2-way valve, double solenoid
P53E	5/3-way valve, mid-position exhausted
004	Reset method
-	Without, double solenoid valve
A	Pneumatic spring
M	Mechanical spring
005	Pilot air supply
-	Internal
006	Manual override
H	With manual override

007	Pneumatic connection (width)
A1	ISO size 01, width 26 mm
A2	ISO size 02, width 18 mm
008	Nominal operating voltage
1	24 V DC
009	Electrical connection
C1	Type C to EN 175301-803
R5	Central plug M12x1
010	Signal status display
-	None
L	LED (integrated)
011	Position sensing
-	Without sensor

Product options

D52	5/2-way valve, double solenoid with dominant signal at 14	T32F	2x 3/2-way valve, normally open, reverse operation
P53C	5/3-way valve, mid-position closed	T32N	2x 3/2-way valve, normally open, reverse operation
P53U	5/3-way valve, mid-position pressurised	T32W	2x 3/2-way valve, normally 1x open, 1x closed, reverse operation
T32C	2x 3/2-way valve, normally closed	T22C	2x 2/2-way valve, normally closed
T32U	2x 3/2-way valve, normally open	Z	External pilot air supply
T32H	2x 3/2-way valve, normally 1x open, 1x closed		

Operating voltage
24 V AC, 110 V AC, 230 V AC, 12 V DC

Electrical connection
R2 Central plug M8x1
R3 Individual plug M12
P1 Without pilot valve

Position sensing
APC Proximity switch PNP with open cable end
APP Proximity switch PNP with plug M8
ANC Proximity switch NPN with open cable end
ANP Proximity switch NPN with plug M8

Configurable product

This product and all its product options can be ordered online via the configurator:

→ www.festo.com/catalogue/vsva

Ordering – Basic design

003 Valve function	007 Pneumatic connection A1 Port pattern to ISO size 26 mm (01)		007 Pneumatic connection A2 Port pattern to ISO size 18 mm (02)	
	Type	Part no.	Type	Part no.
009 Electrical connection R5: with central plug M12x1				
5/2-way valve, single solenoid	VSVA-B-M52-AH-A1-1R5L	534555	VSVA-B-M52-AH-A2-1R5L	546767
	VSVA-B-M52-MH-A1-1R5L	534556	VSVA-B-M52-MH-A2-1R5L	546768
5/2-way valve, double pilot	VSVA-B-B52-H-A1-1R5L	534557	VSVA-B-B52-H-A2-1R5L	546769
5/3-way valve, mid-position exhausted	VSVA-B-P53E-H-A1-1R5L	534560		
009 Electrical connection C1: type C to EN 175301-803 (with pilot control with square plug type C to EN 175301-803)				
5/2-way valve, single solenoid	VSVA-B-M52-AH-A1-1C1	546700	VSVA-B-M52-AH-A2-1C1	546701
	VSVA-B-M52-MH-A1-1C1	546702	VSVA-B-M52-MH-A2-1C1	546703
5/2-way valve, double pilot	VSVA-B-B52-H-A1-1C1	546696	VSVA-B-B52-H-A2-1C1	546697
5/3-way valve, mid-position exhausted	VSVA-B-P53E-H-A1-1C1	546706		

Accessories

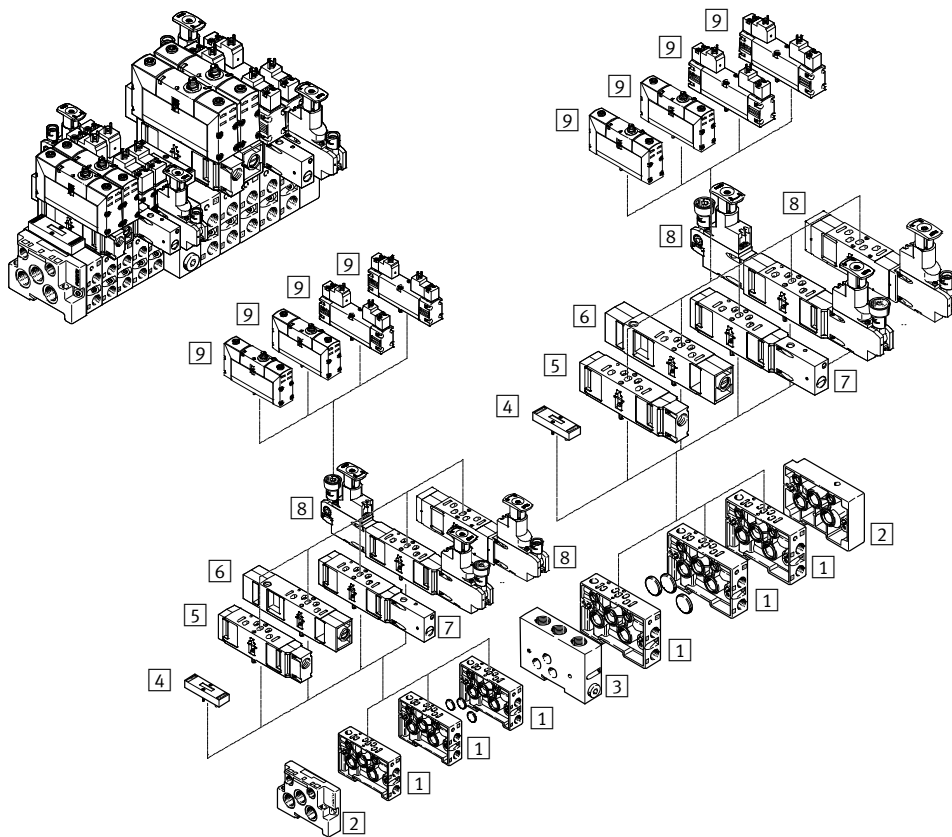

- 1 Manifold sub-base NAW with lateral ports 2 and 4 → 163
- 2 End plate kit NEV for sealing the manifold sub-bases → 163
- 3 Intermediate plate NZV for connecting width 18 mm with width 26 mm → vsva
- 4 Blanking plate NDV for vacant or spare positions → vsva
- 5 Vertical supply plate VABF...P1-A3 for intermediate air supply → vsva
- 6 Flow control plate VABF...F1-B1 for flow control in ducts 3 and 5 → vsva
- 7 Vertical pressure shut-off plate VABF...L1-D1 with switch for manual shut-off of duct 1 → vsva
- 8 Regulator plate VABF...R...-C2 → vsva
- 9 Solenoid valve VSVA → 162

Individual sub-base NAS → 163

1 Manifold sub-base NAW with lateral ports 2 and 4		
For	Type	Part no.
26 mm	NAW-1/4-01-VDMA	161102
18 mm	NAW-1/8-02-VDMA	161110

2 End plate kit NEV		
For	Type	Part no.
26 mm	NEV-01-VDMA	161104
18 mm	NEV-02-VDMA	161112

4 Blanking plate NDV		
For	Type	Part no.
26 mm	NDV-01-VDMA	161107
18 mm	NDV-02-VDMA	161114

Individual sub-base NAS		
For	Type	Part no.
26 mm	NAS-1/4-01-VDMA	161109
18 mm	NAS-1/8-02-VDMA	161115

Electrically and pneumatically actuated directional control valves > Universal directional control valves > Solenoid valves VUVG

Designed for reliable and easy operation

The VUVG has been a huge success since it was introduced. This is due in no small part to its first-class pneumatic performance as well as numerous other technical refinements.

Integrated LED for 360 degree view – convenient for a fast status overview as well as reduced downtimes.

Standard: the non-detenting/detenting manual override for easy commissioning.

Click! Just snap it in and it's done. E-box with numerous connection options for optimum integration into your system concept.

Retained mounting screws: robust, secure mounting, no lost parts.

Imperial connections (inch sizes) can be implemented in a trouble-free fashion with hybrid fittings.

Direction indicator: detent for correct valve installation.

Positive-locking seal integrated into the valve.

Make the most of the available installation space with a host of connection options and functions.

Several pressure zones possible – quickly and easy with separators.

Highly flexible: individual valves can be assembled in series without an additional manifold strip thanks to axial mounting bores.

No additional components required to mount an individual valve onto a valve manifold.



In-line valve VUVG-L10 with seal VABD-L1-10X



Sub-base valve VUVG-B10

- Connection technology via electrical connection box (E-box)
- Specific I-Port interface from Festo for fieldbus node
- IO-Link® mode for direct connection to a higher-level IO-Link® master
- Festo-specific I-Port interface with interlock
- Variable multi-pin plug connection using Sub-D or flat cable
- Sturdy and durable metal components
- Reversible piston spool valves
- Up to 24 valve positions

Order code – Basic design

001	002	003	004	005	006	007	008	009	010	011	012	013	014
VUVG							T			1		L	

001	Type
VUVG	Directional control valve for standard applications
002	Valve type
B	Sub-base valve
L	In-line valve/individual valve
003	Design principle
–	Piston spool with sealing cartridge
K	Piston spool with sealing ring
004	Size
10	Size 10
14	Size 14
18	Size 18
005	Valve function
B52	5/2-way valve, double solenoid
M52	5/2-way valve, single solenoid
P53C	5/3-way valve, mid-position closed
T32C	2x 3/2-way valve, normally closed
006	Reset method
–	Without, for valve function B52 and P53
A	Pneumatic spring, for valve function T32 and M52
M	Mechanical spring, for valve function M52
R	Pneumatic/mechanical spring, for valve function M52
007	Pilot air supply
–	Internal

008	Manual override
T	Non-detenting, detenting
009	Pneumatic connection
M5	M5 thread
M7	M7 thread
G18	G1/8 thread
G14	G1/4 thread
F	Flange/sub-base
010	Exhaust
–	Without fitting
011	Nominal operating voltage
1	24 V DC
012	Electrical connection
R8	Individual plug M8, 3-pin
H2	Connection pattern H, horizontal plug
013	Signal status display
L	LED (integrated)
014	Version
–	Extended features
S	Core features

Legend: Mandatory entry Optional entry

Product options

Type of directional control valve:

S Semi in-line valve

Valve functions:

M32C 3/2-way valve, single solenoid, closed

M32U 3/2-way valve, single solenoid, open

P53U 5/3-way valve, pressurised

P53E 5/3-way valve, exhausted

T32... 2x 3/2-way valve

Pilot air supply:

Z External

Manual override:

S Covered

H Non-detenting

Pneumatic connection:

Push-in connector 6 ... 10 mm

Push-in connector 5/32" ... 3/8"

Exhaust:

U Silencer

QN With fitting

Nominal operating voltage:

5 V DC, 12 V DC

Electrical connection

T1 Plug-in

H... Connection pattern H

S... Connection pattern S

L... With flying leads

K... With cable

R... Individual plugs

P3 Without electrical connection box

Solenoid valves VUVG

Ordering – Product options

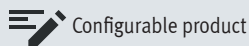

This product and all its product options can be ordered online via the configurator:

→ www.festo.com/catalogue/...

Enter the part number or the type.

Part no.	Type	012 Electrical connection
564212	VUVG	Individual connection
575203	VUVG-...T1	Plug-in

Ordering – Basic design

014 Core features						
004 Size	Type	Part no.	Type	Part no.	Type	Part no.
012 Electrical connection box R8 with individual plug M8, 002 In-line valve/individual valve, 003 Piston spool with sealing ring						
	005 2x3/2-way, normally closed		005 5/2-way, single solenoid		005 5/2-way, double solenoid	
	006 Pneumatic spring		006 Pneumatic spring		006 –	
Size 10	VUVG-LK10-T32C-AT-M5-1R8L-S	8042542	VUVG-LK10-M52-AT-M5-1R8L-S	8042543	VUVG-LK10-B52-T-M5-1R8L-S	8042544
	VUVG-LK10-T32C-AT-M7-1R8L-S	8042550	VUVG-LK10-M52-AT-M7-1R8L-S	8042551	VUVG-LK10-B52-T-M7-1R8L-S	8042552
Size 14	VUVG-LK14-T32C-AT-G18-1R8L-S	8042566	VUVG-LK14-M52-AT-G18-1R8L-S	8042567	VUVG-LK14-B52-T-G18-1R8L-S	8042568
012 Electrical connection box H2 with horizontal plug, 002 In-line valve/individual valve, 003 Piston spool with sealing ring						
	005 2x3/2-way, normally closed		005 5/2-way, single solenoid		005 5/2-way, double solenoid	
	006 Pneumatic spring		006 Pneumatic spring		006 –	
Size 10	VUVG-LK10-T32C-AT-M5-1H2L-S	8042538	VUVG-LK10-M52-AT-M5-1H2L-S	8042539	VUVG-LK10-B52-T-M5-1H2L-S	8042540
	VUVG-LK10-T32C-AT-M7-1H2L-S	8042546	VUVG-LK10-M52-AT-M7-1H2L-S	8042547	VUVG-LK10-B52-T-M7-1H2L-S	8042548
Size 14	VUVG-LK14-T32C-AT-G18-1H2L-S	8042562	VUVG-LK14-M52-AT-G18-1H2L-S	8042563	VUVG-LK14-B52-T-G18-1H2L-S	8042564
012 Electrical connection box R8 with individual plug M8, 002 Sub-base valve, 003 Piston spool with sealing ring						
	005 2x3/2-way, normally closed		005 5/2-way, single solenoid		005 5/2-way, double solenoid	
	006 Pneumatic spring		006 Pneumatic spring		006 –	
Size 10	VUVG-BK10-T32C-AT-F-1R8L-S	8042558	VUVG-BK10-M52-AT-F-1R8L-S	8042559	VUVG-BK10-B52-T-F-1R8L-S	8042560
Size 14	VUVG-BK14-T32C-AT-F-1R8L-S	8042574	VUVG-BK14-M52-AT-F-1R8L-S	8042575	VUVG-BK14-B52-T-F-1R8L-S	8042576
012 Electrical connection box H2 with horizontal plug, 002 Sub-base valve, 003 Piston spool with sealing ring						
	005 2x3/2-way, normally closed		005 5/2-way, single solenoid		005 5/2-way, double solenoid	
	006 Pneumatic spring		006 Pneumatic spring		006 –	
Size 10	VUVG-BK10-T32C-AT-F-1H2L-S	8042554	VUVG-BK10-M52-AT-F-1H2L-S	8042555	VUVG-BK10-B52-T-F-1H2L-S	8042556
Size 14	VUVG-BK14-T32C-AT-F-1H2L-S	8042570	VUVG-BK14-M52-AT-F-1H2L-S	8042571	VUVG-BK14-B52-T-F-1H2L-S	8042572

014 Extended features						
004 Size	Type	Part no.	Type	Part no.	Type	Part no.
012 Electrical connection box R8 with individual plug M8, 002 In-line valve/individual valve, 003 Piston spool with sealing cartridge						
	005 2x3/2-way, normally closed		005 5/2-way, single solenoid		005 5/2-way, double solenoid	
	006 Pneumatic spring		006 Pneumatic/mechanical spring		006 –	
Size 10	VUVG-L10-T32C-AT-M5-1R8L	577347	VUVG-L10-M52-RT-M5-1R8L	572634	VUVG-L10-B52-T-M5-1R8L	576664
	VUVG-L10-T32C-AT-M7-1R8L	574218	VUVG-L10-M52-RT-M7-1R8L	574221	VUVG-L10-B52-T-M7-1R8L	574222
Size 14	VUVG-L14-T32C-AT-G18-1R8L	574226	VUVG-L14-M52-AT-G18-1R8L ¹⁾	574229	VUVG-L14-B52-T-G18-1R8L	574230
Size 18	VUVG-L18-T32C-AT-G14-1R8L	8031525	VUVG-L18-M52-RT-G14-1R8L	8031531		
			VUVG-L18-M52-MT-G14-1R8L ²⁾	8031532		
	005 5/3-way, mid-position closed					
	006 –					
Size 10	VUVG-L10-P53C-T-M5-1R8L	577346				
	VUVG-L10-P53C-T-M7-1R8L	574223				
Size 14	VUVG-L14-P53C-T-G18-1R8L	574231				
Size 18	VUVG-L18-P53C-T-G14-1R8L	8031534				

1) 006 Pneumatic spring
2) 006 Mechanical spring

Accessories

In-line valve VUVG-L with seal

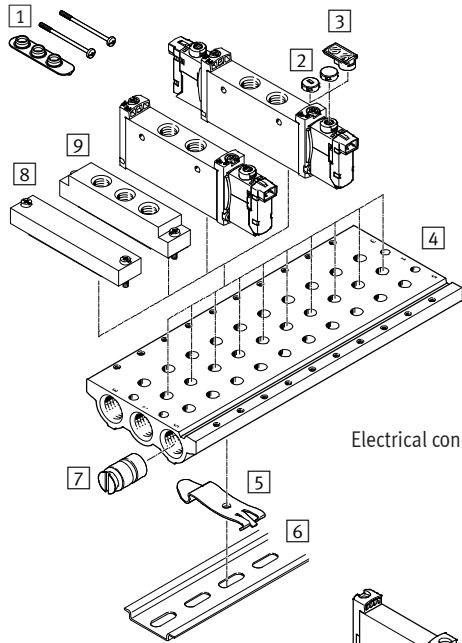

Sub-base valve VUVG-B

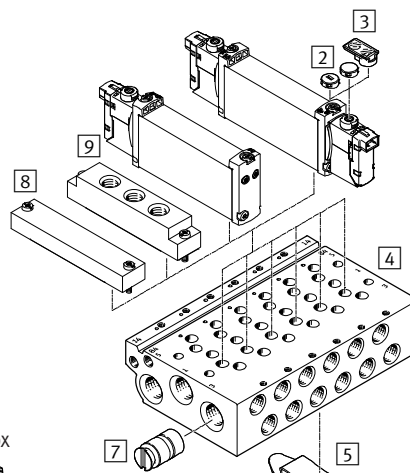

Electrical connection box

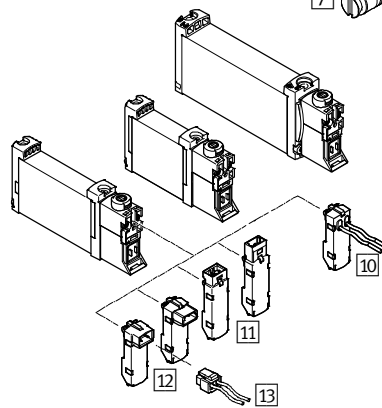

- 1 Seal VABD-L1-10X for in-line valve → 167
 - 2 Cover VMPA-HBT-B for manual override, non-detenting → 167
 - 3 Inscription label holder ASLR-D for labelling the valves, covering the mounting screw and the manual override → 167
 - 4 Manifold rail VABM for 2 to 10 valve positions → 168
 - 5 H-rail mounting VAME-T-M4 for fitting the valve manifold on an H-rail → 167
 - 6 H-rail NRH-35-2000 for mounting → nrh-35
 - 7 Separator VABD-B for creating pressure zones → 168
 - 8 Blanking plate VABB for covering an unused valve position → 168
 - 9 Supply plate VABF → 168
- Electrical connection box VAVE
- 10 With flying leads → 168
 - 11 With vertical plug → 168
 - 12 With horizontal plug → 168
 - 13 Plug socket with cable NEBV, open end → 168

1 Seal VABD-L1-10X			
Size	Pneum. connection	Type	Part no.
For VUVG-L			
002 In-line valve/individual valve, 003 Piston spool with sealing cartridge			
10	M5	VABD-L1-10X-S-M5	566672
10	M7	VABD-L1-10X-S-M7	566673
14	G1/8	VABD-L1-14X-S-G18	566675
18	G1/4	VABD-L1-18X-S-G14	574479
18	G1/4	VABD-L1-18B-S-G14	574480
For VUVG-LK			
002 In-line valve/individual valve, 003 Piston spool with sealing ring			
10	M5	VABD-L1-10XK-S-M5	8043718
10	M7	VABD-L1-10XK-S-M7	8043719
14	G1/8	VABD-L1-14XK-S-G18	8043720

2/3/5 Cover VMPA/inscription label holder ASLR/H-rail mounting VAME		
Size	Type	Part no.
10, 14, 18	VMPA-HBT-B (10 Stück)	540897
10, 14, 18	ASLR-D-L1 (10 Stück)	570818
10, 14, 18	VAME-T-M4 (2 Stück)	569998

Solenoid valves VUVG

Accessories

4 Manifold rail VABM						
Size	Connection 1)	Valve positions	Type	Part no.		
For individual valve VUVG-L with seal VABD-L1-10X 1						
10	M5/M7	2	VABM-L1-10S-G18-2	566558		
		3	VABM-L1-10S-G18-3	566559		
		4	VABM-L1-10S-G18-4	566560		
		6	VABM-L1-10S-G18-6	566562		
		8	VABM-L1-10S-G18-8	566564		
10	M5/M7	10	VABM-L1-10S-G18-10	566566		
		14	G1/4	2	VABM-L1-14S-G14-2	566618
				3	VABM-L1-14S-G14-3	566619
				4	VABM-L1-14S-G14-4	566620
				6	VABM-L1-14S-G14-6	566622
8	VABM-L1-14S-G14-8			566624		
10	M5/M7	10	VABM-L1-14S-G14-10	566626		
		18	G3/8	2	VABM-L1-18S-G38-2	574455
				3	VABM-L1-18S-G38-3	574456
4	VABM-L1-18S-G38-4			574457		
6	VABM-L1-18S-G38-6			574459		
8	VABM-L1-18S-G38-8			574461		
10	VABM-L1-18S-G38-10	574463				
For sub-base valve VUVG-B						
10	M5	2	VABM-L1-10W-G18-2	566582		
		3	VABM-L1-10W-G18-3	566583		
		4	VABM-L1-10W-G18-4	566584		
		6	VABM-L1-10W-G18-6	566586		
		8	VABM-L1-10W-G18-8	566588		
	10	VABM-L1-10W-G18-10	566590			
	M7	2	VABM-L1-10HW-G18-2	566606		
		3	VABM-L1-10HW-G18-3	566607		
		4	VABM-L1-10HW-G18-4	566608		
		6	VABM-L1-10HW-G18-6	566610		
8		VABM-L1-10HW-G18-8	566612			
10	M7	10	VABM-L1-10HW-G18-10	566614		
		14	G1/8	2	VABM-L1-14W-G18-2	566642
				3	VABM-L1-14W-G18-3	566643
				4	VABM-L1-14W-G18-4	566644
				6	VABM-L1-14W-G18-6	566646
8	VABM-L1-14W-G18-8			566648		
10	VABM-L1-14W-G18-10	566650				
18	G3/8	2	VABM-L1-18W-G38-2	574467		
		3	VABM-L1-18W-G38-3	574468		
		4	VABM-L1-18W-G38-4	574469		
		6	VABM-L1-18W-G38-6	574471		
		8	VABM-L1-18W-G38-8	574473		
		10	VABM-L1-18W-G38-10	574475		

1) VABM-L1-...S: Supply ports 1, 3, 5
VABM-L1-...W, VABM-L1-...HW: working ports 2, 4

7 Separator VABD-B		
Size	Type	Part no.
For individual valve VUVG-L		
10	VABD-8-B	569995
14	VABD-10-B	569996
18	VABD-12-B	569997
For sub-base valve VUVG-B		
10	VABD-6-B	569994
14	VABD-10-B	569996
18	VABD-12-B	569997

8 Blanking plate VABB		
Size	Type	Part no.
For individual valve VUVG-L		
10	VABB-L1-10-S	566462
14	VABB-L1-14	569989
18	VABB-L1-18	574482
For sub-base valve VUVG-B		
10	VABB-L1-10-W	566495
14	VABB-L1-14	569989
18	VABB-L1-18	574482

9 Supply plate VABF			
Size	Connection	Type	Part no.
For individual valve VUVG-L			
10	M5	VABF-L1-10-P3A4-M5	569991
10	M7	VABF-L1-10-P3A4-M7	569992
14	G1/8	VABF-L1-14-P3A4-G18	569993
18	G1/4	VABF-L1-18-P3A4-G14	574481
For sub-base valve VUVG-B			
10	M5	VABF-L1-10-P3A4-M5	569991
10	M7	VABF-L1-10-P3A4-M7	569992
14	G1/8	VABF-L1-14-P3A4-G18	569993
18	G1/4	VABF-L1-18-P3A4-G14	574481

10/11/12 Electrical connection box VAVE		
Description	Type	Part no.
a) With flying leads, LED, protective circuit		
0.5 m, 24 and 12 V DC	VAVE-L1-1VL1-LP ³⁾	566722
1 m	VAVE-L1-1VL2-LP ³⁾	566723
2.5 m	VAVE-L1-1VL3-LP ³⁾	566724
1 m	VAVE-L1-1VK7-LP ³⁾	573942
aA Vertical plug, LED, protective circuit		
24 and 12 V DC	VAVE-L1-1VH3-LP ³⁾	566715
aB Horizontal plug, LED, protective circuit		
24 and 12 V DC	VAVE-L1-1VH2-LP ³⁾	566714
24 V DC	VAVE-L1-1H2-LR ²⁾	566716
24 and 12 V DC	VAVE-L1-1VR8-LP ³⁾	573919

1) Additional functions: spark arresting, bipolar, IP40
2) Additional functions: spark arresting, reduction of holding current, IP40
3) Additional functions: spark arresting, bipolar, IP65

13 Plug socket with cable NEBV			
Description	Cable length	Type	Part no.
Straight socket, 2-pin			
Flying leads, open end	0.5 m	NEBV-H1G2-KN-0.5-LE	566654
	1 m	NEBV-H1G2-KN-1-LE2	566655
	2.5 m	NEBV-H1G2-KN-2.5-LE	566656
Individual cable, 0.5 m, open end, 2-pin	0.5 m	NEBV-H1G2-P-0.5-LE2	566658
	1 m	NEBV-H1G2-P-1-LE2	566659
	2.5 m	NEBV-H1G2-P-2.5-LE2	566660

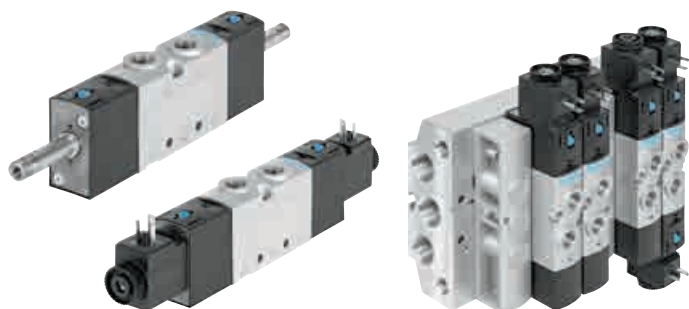

- Width of valves 20 (21 mm), 25 (26.5 mm), 30 (31 mm), flow rate up to 2300 l/min
- In-line valves can be used as individual valves or manifold valves
- Variable pressure zones
- Universal valve, sturdy and durable
- Low-cost, no limitations with regard to performance
- Can be used as a valve manifold VTUS

Order code – Basic design

001 002 003 004 005 006 007 008 009 010 011 012 013 014
 VUVS - L - - - - - D - - - - 1 - - - -

001	Type
VUVS	Solenoid valve
002	Valve type
L	In-line valve
003	Design principle
-	Piston spool with sealing cartridge
K	Piston spool with sealing ring
004	Size
20	Valve width 21 mm
25	Valve width 26.5 mm
30	Valve width 31 mm
005	Valve functions
B52	5/2-way valve, double solenoid
M52	5/2-way valve, single solenoid
P53C	5/3-way valve, mid-position closed
M32C	3/2-way valve, normally closed
006	Reset method
-	Without, for valve function B52
A	Pneumatic spring, for valve function M32 and M52
M	Mechanical spring, for valve function M32, M52 and P53
007	Pilot air supply
-	Internal

008	Manual override
D	Non-detenting, detenting without accessories
009	Pneumatic connection
G18	G1/8 thread
G14	G1/4 thread
G38	G3/8 thread
010	Exhaust
-	Without fitting
011	Valve pilot control interface
-	Standard
F7	With 8 mm armature tube, short
F8	With 8 mm armature tube, standard
012	Nominal operating voltage
1	24 V DC
013	Electrical connection
C1	Connection pattern type C, to EN 175301
B2	Connection pattern type B, industry standard
014	Version
-	Extended features
S	Core features

Legend: Mandatory entry Optional entry

Product options

Design principle:

T Poppet valve

Pilot air supply:

Z External

Pneumatic connection:

Push-in connector 4 ... 12 mm

Nominal operating voltage:

24 V AC, 230 V AC, 230/240 V AC, 12 V DC, 110/120 V AC

Valve functions:

M32U 3/2-way valve, single solenoid, open

P53U 5/3-way valve, pressurised

P53E 5/3-way valve, exhausted

T32... 2x 3/2-way valve

Manual override:

S Covered

H Non-detenting

Exhausting:

QN With fitting

U Silencer

Degree of protection for electrics:

S8 IP67

Solenoid valves VUVS-L

Ordering – Product options

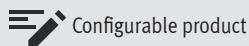

This product and all its product options can be ordered online via the configurator:

→ www.festo.com/catalogue/...

Enter the part number or the type.

Part no.	Type
576516	VUVS-20
8022014	VUVS-25
8022017	VUVS-30

Ordering – Basic design

014 Core features						
004 Size	Type	Part no.	Type	Part no.	Type	Part no.
013 Connection pattern type C, to EN 175 301, 002 In-line valve, 003 Piston spool with sealing ring, 011 With standard valve pilot control interface						
	005 3/2-way, normally closed		005 5/2-way, single solenoid		005 5/2-way, double solenoid	
	006 Pneumatic spring		006 Pneumatic spring		006 –	
20 (valve width 21 mm)	VUVS-LK20-M32C-AD-G18-1C1-S	8043213	VUVS-LK20-M52-AD-G18-1C1-S	8043214	VUVS-LK20-B52-D-G18-1C1-S	8043215
013 Connection pattern type B, industry standard, 002 In-line valve, 003 Piston spool with sealing ring, 011 With standard valve pilot control interface						
	005 3/2-way, normally closed		005 5/2-way, double solenoid		005 5/2-way, single solenoid	
	006 Pneumatic spring		006 –		006 Pneumatic spring	
25 (valve width 26.5 mm)	VUVS-LK25-M32C-AD-G14-1B2-S	8043217	VUVS-LK25-B52-D-G14-1B2-S	8043219	VUVS-LK25-M52-AD-G14-1B2-S	8043218
30 (valve width 31 mm)	VUVS-LK30-M32C-AD-G38-1B2-S	8049880	VUVS-LK30-B52-D-G38-1B2-S	8049882	VUVS-LK30-M52-AD-G38-1B2-S	8049881

014 Extended features						
004 Size	Type	Part no.	Type	Part no.	Type	Part no.
013 Connection pattern type C, to EN 175 301, 002 In-line valve, 003 Piston spool with sealing cartridge, 011 With armature tube valve pilot control interface						
	005 3/2-way, normally closed		005 3/2-way, normally closed		005 5/2-way, single solenoid	
	006 Mechanical spring		006 Pneumatic spring		006 Mechanical spring	
20 (valve width 21 mm)	VUVS-L20-M32C-MD-G18-F7-1C1	575274	VUVS-L20-M32C-AD-G18-F7-1C1	575269	VUVS-L20-M52-MD-G18-F7-1C1	575264
25 (valve width 26.5 mm)	VUVS-L25-M32C-MD-G14-F8-1C1	575477	VUVS-L25-M32C-AD-G14-F8-1C1	575475	VUVS-L25-M52-MD-G14-F8-1C1	575511
30 (valve width 31 mm)	VUVS-L30-M32C-MD-G38-F8-1C1	575570	VUVS-L30-M32C-AD-G38-F8-1C1	575568	VUVS-L30-M52-MD-G38-F8-1C1	575604
	005 5/2-way, single solenoid		005 5/2-way, double solenoid		005 5/3-way, mid-position closed	
	006 Pneumatic spring		006 –		006 Mechanical spring	
20 (valve width 21 mm)	VUVS-L20-M52-AD-G18-F7-1C1	575263	VUVS-L20-B52-D-G18-F7-1C1	575265	VUVS-L20-P53C-MD-G18-F7-1C1	575268
25 (valve width 26.5 mm)	VUVS-L25-M52-AD-G14-F8-1C1	575503	VUVS-L25-B52-D-G14-F8-1C1	575518	VUVS-L25-P53C-MD-G14-F8-1C1	575525
30 (valve width 31 mm)	VUVS-L30-M52-AD-G38-F8-1C1	575596	VUVS-L30-B52-D-G38-F8-1C1	575611	VUVS-L30-P53C-MD-G38-F8-1C1	575618

Accessories

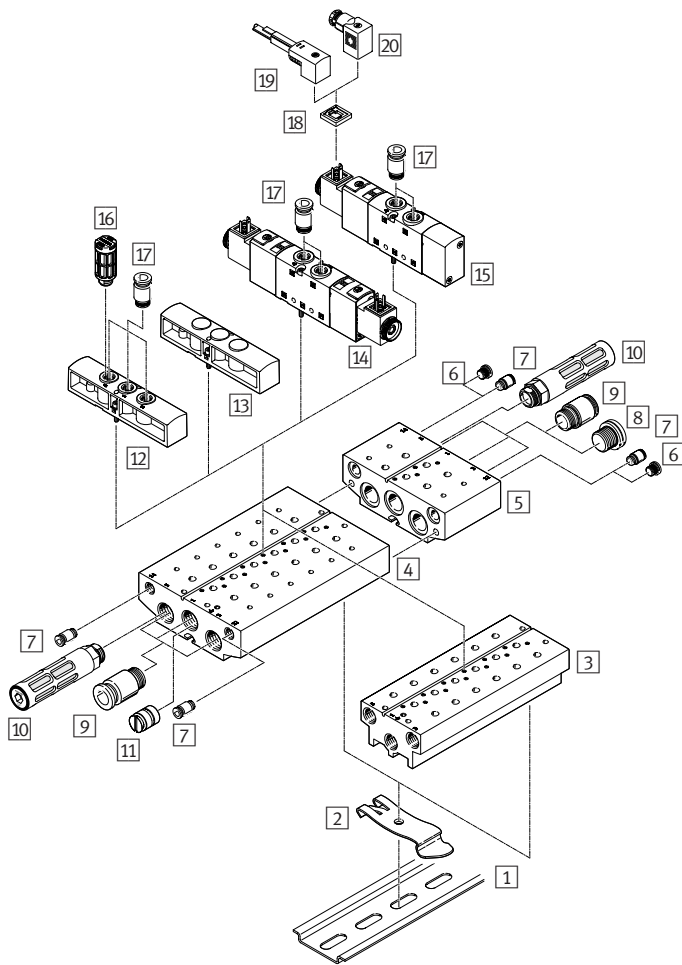

- 1 H-rail NRH-35-2000 → nrh-35
 - 2 H-rail mounting VAME-T-M4 → vuvvs-l
 - 3 Manifold block, compact VABM-B10-20S → 172
 - 4 Manifold block, standard VABM-B10-20E → vuvvs-l
 - 5 Extension module for standard manifold block VABM-B10-20EEE → vuvvs-l
 - 6 Blanking plug B with connecting thread → 305
 - 7 Push-in fitting QS → 293
 - 8 Blanking plug B with connecting thread → 305
 - 9 Push-in fitting QS → 293
 - 10 Silencer U → 317
 - 11 Separator VABD → vuvvs-l
 - 12 Supply plate VABF-B10-20-P1A4 → vuvvs-l
 - 13 Blanking plate VABB-B10 → 171
 - 14 Solenoid valve VUVS, 5/3-way valve and 5/2-way valve, double solenoid, with solenoid coil
 - 15 Solenoid valve VUVS, 5/2-way valve, single solenoid, with solenoid coil
 - 16 Silencer U → 317
 - 17 Push-in fitting QS → 293
 - 18 Illuminating seal MEB-LD → vuvvs-l
 - 19 Plug socket with cable KMEB → 172
Plug socket with cable KMF → 172
 - 20 Plug socket MSSD → 172
- Solenoid coil VACS-C, VACF-B → 172

Accessories

13 Blanking plate VABB-B10		
Size	Type	Part no.
For valve position on manifold block for 3/2-way valves		
20	VABB-B10-20-E-P3	576411
25	VABB-B10-25-E-P3	8026210
30	VABB-B10-30-E-P3	8026336
For valve position on manifold block for 5/2-way, 5/3-way valves		
20	VABB-B10-20-E	576410
25	VABB-B10-25-E	8026209
30	VABB-B10-30-E	8026335
For valve position on supply manifold		
20	VABB-B10-20-A	576409
25	VABB-B10-25-A	8026208
30	VABB-B10-30-A	8026334

Electrically and pneumatically actuated directional control valves > Universal directional control valves >

Solenoid valves VUVS-L

Accessories

3 Manifold block, compact VABM-B10-20S/VABM-B10-25S				
Width	Pneumatic connection	Valve positions	Type	Part no.
For 3/2-way valves, incl. seals and screws for mounting valves				
20 (21 mm)	G1/4	2	VABM-B10-20S-G14-2-P3	576465
		4	VABM-B10-20S-G14-4-P3	576467
		6	VABM-B10-20S-G14-6-P3	576469
		8	VABM-B10-20S-G14-8-P3	576471
		10	VABM-B10-20S-G14-10-P3	576473
25 (26.5 mm)	G3/8	2	VABM-B10-25S-G38-2-P3	8026297
		4	VABM-B10-25S-G38-4-P3	8026299
		6	VABM-B10-25S-G38-6-P3	8026301
		8	VABM-B10-25S-G38-8-P3	8026303
		10	VABM-B10-25S-G38-10-P3	8026305
30 (31 mm)	G1/2	2	VABM-B10-30S-G12-2-P3	8026413
		4	VABM-B10-30S-G12-4-P3	8026415
		6	VABM-B10-30S-G12-6-P3	8026417
		8	VABM-B10-30S-G12-8-P3	8026419
		10	VABM-B10-30S-G12-10-P3	8026421
For 5/2-way and 5/3-way valves, incl. seals and screws for valve assembly				
20 (21 mm)	G1/4	2	VABM-B10-20S-G14-2	576417
		4	VABM-B10-20S-G14-4	576419
		6	VABM-B10-20S-G14-6	576421
		8	VABM-B10-20S-G14-8	576423
		10	VABM-B10-20S-G14-10	576425
25 (26.5 mm)	G3/8	2	VABM-B10-25S-G38-2	8026261
		4	VABM-B10-25S-G38-4	8026263
		6	VABM-B10-25S-G38-6	8026265
		8	VABM-B10-25S-G38-8	8026267
		10	VABM-B10-25S-G38-10	8026269
30 (31 mm)	G1/2	2	VABM-B10-30S-G12-2	8026377
		4	VABM-B10-30S-G12-4	8026379
		6	VABM-B10-30S-G12-6	8026381
		8	VABM-B10-30S-G12-8	8026383
		10	VABM-B10-30S-G12-10	8026385
Common supply manifold for mounting on both sides, incl. seals and screws for valve assembly				
20 (21 mm)	G3/8	2	VABM-B10-20-G38-2-P53	576363
		4	VABM-B10-20-G38-4-P53	576365
		6	VABM-B10-20-G38-6-P53	576367
		8	VABM-B10-20-G38-8-P53	576369
		10	VABM-B10-20-G38-10-P53	576371
25 (26.5 mm)	G1/2	2	VABM-B10-25-G12-2-P53	8026219
		4	VABM-B10-25-G12-4-P53	8026221
		6	VABM-B10-25-G12-6-P53	8026223
		8	VABM-B10-25-G12-8-P53	8026225
		10	VABM-B10-25-G12-10-P53	8026227
30 (31 mm)	G3/4	2	VABM-B10-30-G34-2-P53	8026338
		4	VABM-B10-30-G34-4-P53	8026340
		6	VABM-B10-30-G34-6-P53	8026342
		8	VABM-B10-30-G34-8-P53	8026344
		10	VABM-B10-30-G34-10-P53	8026346

19 Plug socket with cable KMEB			
Description	Cable length	Type	Part no.
Angled socket, 3-pin, 24 V DC, type C, to EN 175301-803			
With LEDs	2.5 m	KMEB-1-24-2,5-LED	151688
	5 m	KMEB-1-24-5-LED	151689

19 Plug socket with cable KMF			
Description	Cable length	Type	Part no.
Angled socket, 3-pin, 24 V DC, type B, industry standard			
With LED	2.5 m	KMF-1-24DC-2,5-LED	30935
	5 m	KMF-1-24DC-5-LED	30937

20 Plug socket MSSD			
Description	Type	Part no.	
Angled socket, 3-pin, 0 ... 250 V AC/DC, square plug, type C, to EN 175301-803			
Cable connector Pg7	MSSD-EB	151687	
Angled socket, 3-pin, 0 ... 250 V AC/DC, square design MSF, type B, industry standard			
Cable connector Pg9	MSSD-F	34431	

Solenoid coil VACS-C for width 20		
Description	Type	Part no.
Connection pattern type C, to EN 175 301		
12 V DC	VACS-C-C1-5	8025331
24 V DC	VACS-C-C1-1	8025330
48 V DC	VACS-C-C1-7	8025336
24 V AC; 50/60 Hz	VACS-C-C1-1A	8025335
48 V AC; 50/60 Hz	VACS-C-C1-7A	8025337
110/120 V AC; 50/60 Hz	VACS-C-C1-16B	8025334
230/240 V AC; 50/60 Hz	VACS-C-C1-3W	8025338

Solenoid coil VACF-B for width 25, 30		
Description	Type	Part no.
Connection pattern type B, industry standard		
12 V DC	VACF-B-B2-5	8030801
24 V DC	VACF-B-B2-1	8030802
48 V DC	VACF-B-B2-7	8030803
24 V AC; 50/60 Hz	VACF-B-B2-1A	8030804
48 V AC; 50/60 Hz	VACF-B-B2-7A	8030805
110/120 V AC; 50/60 Hz	VACF-B-B2-16B	8030806
230/240 V AC; 50/60 Hz	VACF-B-B2-3W	8030808
Connection pattern type C, to EN 175 301		
12 V DC	VACF-B-C1-5	8030810
24 V DC	VACF-B-C1-1	8030811
48 V DC	VACF-B-C1-7	8030812
24 V AC; 50/60 Hz	VACF-B-C1-1A	8030813
48 V AC; 50/60 Hz	VACF-B-C1-7A	8030814
110/120 V AC; 50/60 Hz	VACF-B-C1-16B	8030815
230/240 V AC; 50/60 Hz	VACF-B-C1-3W	8030817
Connection pattern type A, to EN 175301-803		
24 V DC	VACF-A-A1-1	8030822



- Low actuating forces
- Ergonomic and reliable operation
- Practical connection with threaded connection or connecting pieces
- Fast mounting: via retaining bracket or screwed directly via through-hole
- Robust metal housing
- Reversible

Order code

001 002 003 004 005 006 007 008
 VHEF - HS [] [] [] [] [] [] [] []

Legend: [] Mandatory entry [] Optional entry

001	Type
VHEF	Manually actuated valves
002	Actuation
HS	Hand lever, on the side
003	Design principle
-	Piston spool
T	Disc seat
004	Type of control
-	Directly actuated
005	Pilot air
-	Internal

006	Valve function
B32	3/2-way valve, detenting (bistable)
B52	5/2-way valve, detenting (bistable)
M32	3/2-way valve, monostable, normally closed or open
M52	5/2-way valve, monostable, resetting
B53C	5/3-way valve, detenting, mid position closed
B53E	5/3-way valve, detenting, mid-position exhausted
P53C	5/3-way valve, mid-position closed
P53E	5/3-way valve, mid-position exhausted
007	Reset method for single solenoid valves
-	Without (for double pilot valves)
M	Mechanical spring
008	Pneumatic connection
G18	G1/8 thread
G14	G1/4 thread
N18	1/8 NPT thread
N14	1/4 NPT thread

Ordering – VHEF-HS, G thread

006 Valve function	007 Reset	008 Pneumatic connection	Standard nominal flow rate	Type	Part no.
3/2-way valve	-	G1/8	750 l/min	VHEF-HST-B32-G18	4165861
		G1/4	870 l/min	VHEF-HST-B32-G14	4165862
	Mechanical spring	G1/8	750 l/min	VHEF-HST-M32-M-G18	4165853
		G1/4	870 l/min	VHEF-HST-M32-M-G14	4165854
5/2-way valve	Mechanical spring	G1/8	750 l/min	VHEF-HS-M52-M-G18	4165855
		G1/4	1200 l/min	VHEF-HS-M52-M-G14	4165856
	-	G1/8	750 l/min	VHEF-HS-B52-G18	4165863
		G1/4	1200 l/min	VHEF-HS-B52-G14	4165864
5/3-way valve	-	G1/8	700 l/min	VHEF-HS-B53C-G18	4165865
		G1/4	1200 l/min	VHEF-HS-B53C-G14	4165866
		G1/8	530 l/min	VHEF-HS-B53E-G18	4165867
		G1/4	900 l/min	VHEF-HS-B53E-G14	4165868
	Mechanical spring	G1/8	700 l/min	VHEF-HS-P53C-M-G18	4165857
		G1/4	1200 l/min	VHEF-HS-P53C-M-G14	4165858
		G1/8	530 l/min	VHEF-HS-P53E-M-G18	4165859
		G1/4	900 l/min	VHEF-HS-P53E-M-G14	4165860

Manually actuated directional control valves > Swivel lever valves >

Hand lever valves VHEF-HS

Ordering – VHEF-HS, NPT thread

006 Valve function	007 Reset	008 Pneumatic connection	Standard nominal flow rate	Type	Part no.
3/2-way valve	–	1/8 NPT	750 l/min	VHEF-HST-B32-N18	4414861
		1/4 NPT	870 l/min	VHEF-HST-B32-N14	4414862
	Mechanical spring	1/8 NPT	750 l/min	VHEF-HST-M32-M-N18	4414853
		1/4 NPT	870 l/min	VHEF-HST-M32-M-N14	4414854
5/2-way valve	Mechanical spring	1/8 NPT	750 l/min	VHEF-HS-M52-M-N18	4414855
		1/4 NPT	1200 l/min	VHEF-HS-M52-M-N14	4414856
	–	1/8 NPT	750 l/min	VHEF-HS-B52-N18	4414863
		1/4 NPT	1200 l/min	VHEF-HS-B52-N14	4414864
5/3-way valve	–	1/8 NPT	700 l/min	VHEF-HS-B53C-N18	4414865
		1/4 NPT	1200 l/min	VHEF-HS-B53C-N14	4414866
		1/8 NPT	530 l/min	VHEF-HS-B53E-N18	4414867
		1/4 NPT	900 l/min	VHEF-HS-B53E-N14	4414868
	Mechanical spring	1/8 NPT	700 l/min	VHEF-HS-P53C-M-N18	4414857
		1/4 NPT	1200 l/min	VHEF-HS-P53C-M-N14	4414858
		1/8 NPT	530 l/min	VHEF-HS-P53E-M-N18	4414859
		1/4 NPT	900 l/min	VHEF-HS-P53E-M-N14	4414860

Accessories

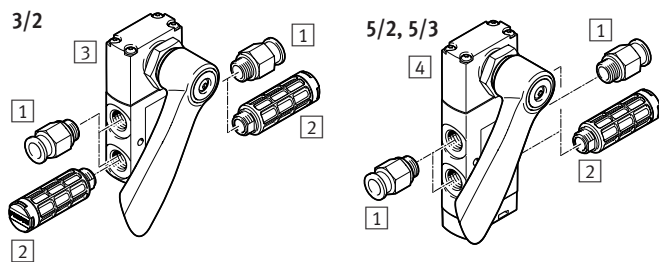

- 1 Fitting for supply air/exhaust air ports (1, 3, 5) and working ports (2, 4)
Push-in fittings QS, G thread → 293
Push-in fittings QB, NPT thread → 174
- 2 Silencer U, for exhaust air ports (3, 5)
G thread → 317
NPT thread → 174
- 3 3/2-way valve VHEF-HST...32...
- 4 5/2- or 5/3-way valve VHEF-HS...52..., VHEF-HS...53...

Accessories for VHEF, UNF/NPT thread

1 Push-in fitting QB, straight
Male thread with internal hex

Connection 1	Connection 2	Type	Part no.
UNF10-32	1/8"	QBM-10-32-UNF-1/8-I-U	572311
	5/32"	QBM-10-32-UNF-5/32-I-U	572312
	1/4"	QBM-10-32-UNF-1/4-I-U	573054
1/8 NPT	5/32"	QB-1/8-5/32-I-U	572317
	1/4"	QB-1/8-1/4-I-U	572318
	5/16"	QB-1/8-5/16-I-U	572319
1/4 NPT	1/4"	QB-1/4-3/8-I-U	572320
	5/16"	QB-1/4-5/16-I-U	572321
	3/8"	QB-1/4-3/8-I-U	572322

1 Push-in fitting QBL, angled
Male thread with external hex

Connection 1	Connection 2	Type	Part no.
1/8 NPT	5/32"	QBL-1/8-5/32-U	533290
	1/4"	QBL-1/8-1/4-U	533292
	5/16"	QBL-1/8-5/16-U	533293
1/4 NPT	5/16"	QBL-1/4-5/16-U	533296
	3/8"	QBL-1/4-3/8-U	533297
	1/2"	QBL-1/4-1/2-U	567775

1 Push-in fitting QB, straight
Male thread with external hex

Connection 1	Connection 2	Type	Part no.
UNF10-32	5/32"	QB-10-32-UNF-5/32-U	533267
	1/4"	QB-10-32-UNF-1/4-U	533269
1/8 NPT	5/32"	QB-1/8-5/32-U	533271
	1/4"	QB-1/8-1/4-U	533273
	5/16"	QB-1/8-5/16-U	533274
1/4 NPT	1/4"	QB-1/4-1/4-U	533276
	5/16"	QB-1/4-5/16-U	533277
	3/8"	QB-1/4-3/8-U	533278

1 Push-in fitting QBLL, angled, long
Male thread with external hex

Connection 1	Connection 2	Type	Part no.
1/8 NPT	5/32"	QBLL-1/8-5/32-U	564668
	1/4"	QBLL-1/8-1/4-U	564670
	5/16"	QBLL-1/8-5/16-U	564671

2 Silencer U, metal variant

Pneumatic connection	Type	Part no.
1/8 NPT	U-1/8-B-NPT	12638
1/4 NPT	U-1/4-B-NPT	12639



- Lever position sensing
- Connection M5, G1/8, G1/4, G1/2, 1/8 NPT, 1/4 NPT, 1/2 NPT
- Flow rates 170 ... 3800 l/min

Order code

001 002 003 004 005 006 007
VHER - - **H** - - - -

Legend: Mandatory entry Optional entry

001	Type
VHER	Hand lever valve with detent
002	Design
-	Hand lever, metal version
P	Hand lever, polymer version
003	Actuation type
H	Hand lever, top
004	Valve function
B43C	4/3-way valve, detenting, mid-position closed
B43E	4/3-way valve, detenting, mid-position open
B43U	4/3-way valve, detenting, mid-position pressurised
005	Direction of flow
-	Not reversible

006	Connection direction, pneumatic connection
-	On the side
B	Underneath
007	Connection size, pneumatic connection
M5	M5
G18	G1/8
G14	G1/4
G12	G1/2
N18	1/8 NPT
N14	1/4 NPT
N12	1/2 NPT

Ordering – VHER, metric/G thread



006 Connection direction	007 Connection	Standard nominal flow rate	Type	Part no.
002 Metal lever				
	G1/8	800 l/min	VHER-H-B43U-B-G18	3488215
	G1/4	1500 l/min	VHER-H-B43U-B-G14	3515286
	G1/2	3800 l/min	VHER-H-B43U-B-G12	3192072
	G1/8	600 l/min	VHER-H-B43U-G18	3488214
	G1/4	1150 l/min	VHER-H-B43U-G14	3515108
	G1/2	3200 l/min	VHER-H-B43U-G12	3192071
	G1/8	800 l/min	VHER-H-B43C-B-G18	3488205
	G1/4	1500 l/min	VHER-H-B43C-B-G14	3515202
	G1/2	3800 l/min	VHER-H-B43C-B-G12	3192066
	G1/8	600 l/min	VHER-H-B43C-G18	3488204
	G1/4	1150 l/min	VHER-H-B43C-G14	3514710
	G1/2	3200 l/min	VHER-H-B43C-G12	3192065
	G1/8	800 l/min	VHER-H-B43E-B-G18	3488207
	G1/4	1500 l/min	VHER-H-B43E-B-G14	3515258
	G1/2	3800 l/min	VHER-H-B43E-B-G12	3192068
	G1/8	600 l/min	VHER-H-B43E-G18	3488206
	G1/4	1150 l/min	VHER-H-B43E-G14	3515082
	G1/2	3200 l/min	VHER-H-B43E-G12	3192067

006 Connection direction	007 Connection	Standard nominal flow rate	Type	Part no.
002 Polymer lever				
	M5	260 l/min	VHER-P-H-B43U-B-M5	3410684
	G1/8	800 l/min	VHER-P-H-B43U-B-G18	3488217
	G1/4	1500 l/min	VHER-P-H-B43U-B-G14	3515683
	G1/2	3800 l/min	VHER-P-H-B43U-B-G12	3192084
	M5	170 l/min	VHER-P-H-B43U-M5	3410683
	G1/8	600 l/min	VHER-P-H-B43U-G18	3488216
	G1/4	1150 l/min	VHER-P-H-B43U-G14	3515573
	G1/2	3200 l/min	VHER-P-H-B43U-G12	3192082
	M5	260 l/min	VHER-P-H-B43C-B-M5	3410680
	G1/8	800 l/min	VHER-P-H-B43C-B-G18	3488209
	G1/4	1500 l/min	VHER-P-H-B43C-B-G14	3515601
	G1/2	3800 l/min	VHER-P-H-B43C-B-G12	3192075
	M5	170 l/min	VHER-P-H-B43C-M5	3410679
	G1/8	600 l/min	VHER-P-H-B43C-G18	3488208
	G1/4	1150 l/min	VHER-P-H-B43C-G14	3515361
	G1/2	3200 l/min	VHER-P-H-B43C-G12	3192074
	M5	260 l/min	VHER-P-H-B43E-B-M5	3410682
	G1/8	800 l/min	VHER-P-H-B43E-B-G18	3488211
	G1/4	1500 l/min	VHER-P-H-B43E-B-G14	3515640
	G1/2	3800 l/min	VHER-P-H-B43E-B-G12	3192077
	M5	170 l/min	VHER-P-H-B43E-M5	3410681
	G1/8	600 l/min	VHER-P-H-B43E-G18	3488210
	G1/4	1150 l/min	VHER-P-H-B43E-G14	3515542
	G1/2	3200 l/min	VHER-P-H-B43E-G12	3192076

Manually actuated directional control valves > Swivel lever valves >

Hand lever valves VHER

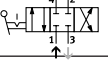
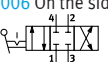
Ordering – VHER, NPT thread

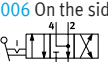
006 Connection direction	007 Connection	Standard nominal flow rate	Type	Part no.
002 Metal lever				
	1/8 NPT	800 l/min	VHER-H-B43C-B-N18	3488213
	1/4 NPT	1500 l/min	VHER-H-B43C-B-N14	3520389
	1/2 NPT	3800 l/min	VHER-H-B43C-B-N12	3192086
	1/8 NPT	600 l/min	VHER-H-B43C-N18	3488212
	1/4 NPT	1150 l/min	VHER-H-B43C-N14	3520365
	1/2 NPT	3200 l/min	VHER-H-B43C-N12	3192085
	1/2 NPT	3800 l/min	VHER-H-B43E-B-N12	3192088
	1/2 NPT	3200 l/min	VHER-H-B43E-N12	3192087

Accessories

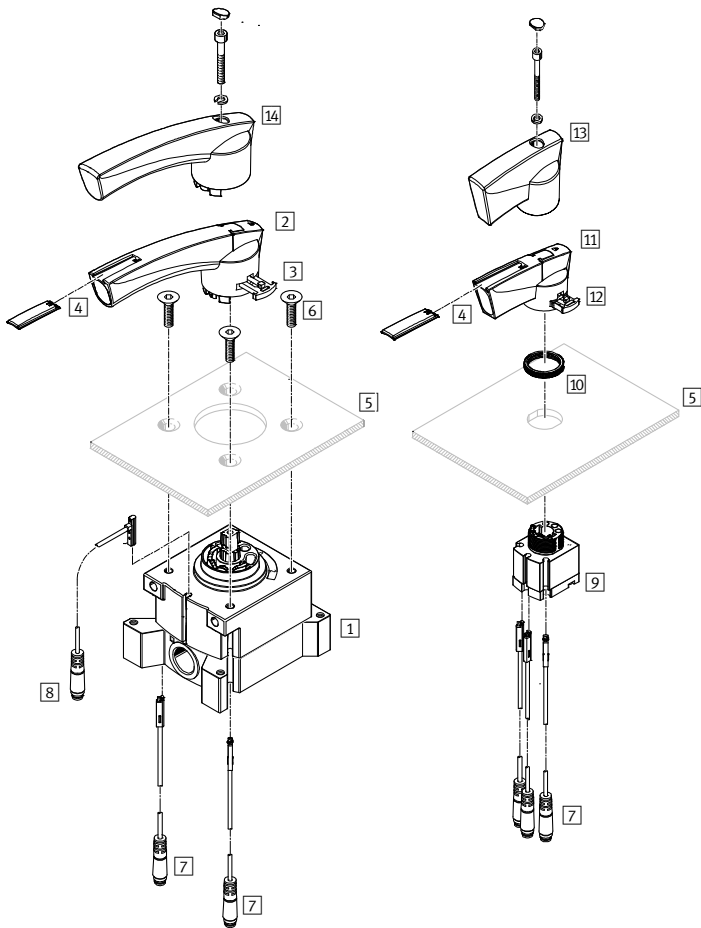

- 1 Hand lever valve VHER (lateral pneumatic connection) → 175
- 2 Actuating lever, large, polymer
- 3 Lever mounting clip, large
- 4 Inscription label
- 5 Control panel (not included in the scope of delivery)
- 6 Mounting screws (not included in the scope of delivery)
- 7 Proximity switch SME-10-... -L-... (electrical connection, in-line) → 176
- 8 Proximity switch SME-10-... -Q-... (electrical connection, lateral) → [vher](#)
- 9 Hand lever valve VHER (pneumatic connections underneath) → 175
- 10 Knurled nut, control panel mounting
- 11 Actuating lever, small, polymer
- 12 Lever mounting clip, small
- 13 Actuating lever, small, metal
- 14 Actuating lever, large, metal

7 Proximity switch, magnetic reed

Description	Type	Part no.
Cable, 2.5 m, 3-wire	SME-10-KL-LED-24	173210
Connector M8x1, 3-pin	SME-10-SL-LED-24	173212



- Precise mechanical system
- Low actuating forces
- Ergonomic and reliable operation
- Practical connection with threaded connection or connecting pieces
- Fast mounting: via retaining bracket or screwed directly via through-hole
- Robust metal housing
- Reversible

Order code

001 002 003 004 005 006 007 008
 VHEF - P - - - - - - -

Legend: Mandatory entry Optional entry

001	Type
VHEF	Manually actuated valves
002	Actuation
P	Pushbutton
003	Design principle
-	Piston spool
T	Disc seat
004	Type of control
-	Directly actuated
C	Indirectly actuated
005	Pilot air
-	Internal
Z	External

006	Valve function
B32	3/2-way valve, detenting (bistable)
B52	5/2-way valve, detenting (bistable)
M32	3/2-way valve, monostable, normally closed or open
M52	5/2-way valve, monostable, resetting
007	Reset method for monostable valves
-	None (for double pilot valves)
M	Mechanical spring
008	Pneumatic connection
G18	G1/8 thread
G14	G1/4 thread
N18	1/8 NPT thread
N14	1/4 NPT thread

Ordering – VHEF-P, G thread

006 Valve function	007 Reset	008 Pneumatic connection	Standard nominal flow rate	Type	Part no.
3/2-way valve	-	G1/8	750 l/min	VHEF-PTC-B32-G18	5299707
		G1/4	870 l/min	VHEF-PTC-B32-G14	5299713
	Mechanical	G1/8	750 l/min	VHEF-PTC-M32-M-G18	5299705
		G1/4	870 l/min	VHEF-PTC-M32-M-G14	5299711
	-	G1/8	750 l/min	VHEF-PTCZ-B32-G18	5299708
		G1/4	870 l/min	VHEF-PTCZ-B32-G14	5299714
	Mechanical	G1/8	750 l/min	VHEF-PTCZ-M32-M-G18	5299706
		G1/4	870 l/min	VHEF-PTCZ-M32-M-G14	5299712
5/2-way valve	-	G1/8	750 l/min	VHEF-P-B52-G18	5299710
	Mechanical	G1/4		VHEF-P-M52-M-G18	5299709
	-	G1/8	1200 l/min	VHEF-P-B52-G14	5299716
	Mechanical	G1/4		VHEF-P-M52-M-G14	5299715

Manually actuated directional control valves >

Pushbutton valves VHEF-P

Ordering – VHEF-P, NPT thread

006 Valve function	007 Reset	008 Pneumatic connection	Standard nominal flow rate	Type	Part no.
3/2-way valve	–	1/8 NPT	750 l/min	VHEF-PTC-B32-N18	5299719
		1/4 NPT	870 l/min	VHEF-PTC-B32-N14	5299725
	Mechanical	1/8 NPT	750 l/min	VHEF-PTC-M32-M-N18	5299717
		1/4 NPT	870 l/min	VHEF-PTC-M32-M-N14	5299723
	–	1/8 NPT	750 l/min	VHEF-PTCZ-B32-N18	5299720
		1/4 NPT	870 l/min	VHEF-PTCZ-B32-N14	5299726
	Mechanical	1/8 NPT	750 l/min	VHEF-PTCZ-M32-M-N18	5299718
		1/4 NPT	870 l/min	VHEF-PTCZ-M32-M-N14	5299724
5/2-way valve	–	1/8 NPT	750 l/min	VHEF-P-B52-N18	5299722
	Mechanical	1/8 NPT		VHEF-P-M52-M-N18	5299721
	–	1/4 NPT	1200 l/min	VHEF-P-B52-N14	5299728
	Mechanical	1/4 NPT		VHEF-P-M52-M-N14	5299727

Accessories

3/2

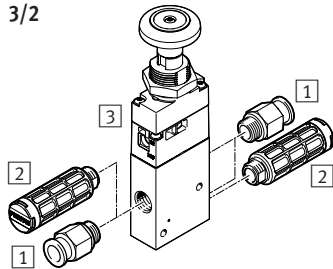

5/2

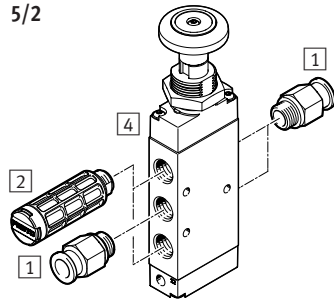

- 1 Fitting for supply air/exhaust air ports (1, 3, 5) and working ports (2, 4)
Push-in fittings QS, G thread → 293
Push-in fittings QB, NPT thread → 174
- 2 Silencer U, for exhaust air ports (3, 5)
G thread → 317
NPT thread → 174
- 3 3/2-way valve VHEF-PTC-M32... , VHEF-PTCZ-M32...
- 4 5/2-way valve VHEF-P-M52...



- Precise mechanical system
- Low actuating forces
- Ergonomic and reliable operation
- Practical connection with threaded connection or connecting pieces
- Fast mounting: via retaining bracket or screwed directly via through-hole
- Robust metal housing
- Reversible

Order code

001 002 003 004 005 006 007 008
 VHEF - L - - - - - - -

Legend: Mandatory entry Optional entry

001	Type
VHEF	Manually actuated valves
002	Actuation
L	Finger lever
003	Design principle
-	Piston spool
T	Disc seat
004	Type of control
-	Directly actuated
005	Pilot air
-	Internal

006	Valve function
M32	3/2-way valve, monostable, normally closed or open
M52	5/2-way valve, monostable, resetting
007	Reset method for monostable valves
E	Pneumatic spring
M	Mechanical spring
008	Pneumatic connection
G18	G1/8 thread
G14	G1/4 thread
N18	1/8 NPT thread
N14	1/4 NPT thread

Ordering – VHEF-L, G thread

006 Valve function	007 Reset	008 Pneumatic connection	Standard nominal flow rate	Type	Part no.
3/2-way valve	Mechanical spring	G1/8	750 l/min	VHEF-LT-M32-M-G18	4500009
		G1/4	870 l/min	VHEF-LT-M32-M-G14	4500008
5/2-way valve	Mechanical spring	G1/8	750 l/min	VHEF-L-M52-M-G18	4500001
	Pneumatic spring	G1/8	750 l/min	VHEF-L-M52-E-G18	4500005
	Mechanical spring	G1/4	1200 l/min	VHEF-L-M52-M-G14	4500000
	Pneumatic spring	G1/4	1200 l/min	VHEF-L-M52-E-G14	4500004

Ordering – VHEF-L, NPT thread

006 Valve function	007 Reset	008 Pneumatic connection	Standard nominal flow rate	Type	Part no.
3/2-way valve	Mechanical spring	1/8 NPT	750 l/min	VHEF-LT-M32-M-N18	4500011
		1/4 NPT	870 l/min	VHEF-LT-M32-M-N14	4500010
5/2-way valve	Mechanical spring	1/8 NPT	750 l/min	VHEF-L-M52-M-N18	4500003
	Pneumatic spring	1/8 NPT	750 l/min	VHEF-L-M52-E-N18	4500007
	Mechanical spring	1/4 NPT	1200 l/min	VHEF-L-M52-M-N14	4500002
	Pneumatic spring	1/4 NPT	1200 l/min	VHEF-L-M52-E-N14	4500006

Accessories

3/2

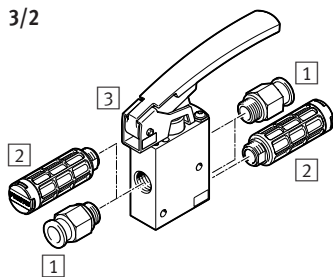

5/2

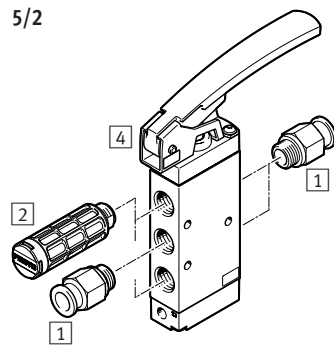

- 1 Fitting for supply air/exhaust air ports (1, 3, 5) and working ports (2, 4)
Push-in fittings QS, G thread → 293
Push-in fittings QB, NPT thread → 174
- 2 Silencer U, for exhaust air ports (3, 5)
G thread → 317
NPT thread → 174
- 3 3/2-way valve VHEF-LT-M32...
- 4 5/2-way valve VHEF-L-M52...



- Precise mechanical system
- Low actuating forces
- Ergonomic and reliable operation
- Practical connection with threaded connection or connecting pieces
- Fast mounting: via retaining bracket or screwed directly via through-hole
- Robust metal housing
- Reversible

Order code

001 002 003 004 005 006 007 008
 VHEF - ES

Legend: Mandatory entry Optional entry

001	Type
VHEF	Manually actuated valves
002	Actuation
ES	Selector switch, on the side
003	Design principle
-	Piston spool
T	Disc seat
004	Type of control
-	Directly actuated
005	Pilot air
-	Internal

006	Valve function
B32	3/2-way valve, detenting (bistable)
B52	5/2-way valve, detenting (bistable)
M32	3/2-way valve, monostable, normally closed or open
M52	5/2-way valve, monostable, resetting
B53C	5/3-way valve, detenting, mid position closed
B53E	5/3-way valve, detenting, mid-position exhausted
P53C	5/3-way valve, mid-position closed
P53E	5/3-way valve, mid-position exhausted
007	Reset method for single solenoid valves
-	None (for double pilot valves)
M	Mechanical spring
008	Pneumatic connection
G18	G1/8 thread
G14	G1/4 thread
N18	1/8 NPT thread
N14	1/4 NPT thread

Ordering – VHEF-ES, G thread

006 Valve function	007 Reset	008 Pneumatic connection	Standard nominal flow rate	Type	Part no.
3/2-way valve	-	G1/8	750 l/min	VHEF-EST-B32-G18	4106814
		G1/4	870 l/min	VHEF-EST-B32-G14	4106815
	Mechanical spring	G1/8	750 l/min	VHEF-EST-M32-M-G18	4106806
		G1/4	870 l/min	VHEF-EST-M32-M-G14	4106807
5/2-way valve	Mechanical spring	G1/8	750 l/min	VHEF-ES-M52-M-G18	4106808
		G1/4	1200 l/min	VHEF-ES-M52-M-G14	4106809
	-	G1/8	750 l/min	VHEF-ES-B52-G18	4106816
		G1/4	1200 l/min	VHEF-ES-B52-G14	4106817
5/3-way valve	-	G1/8	700 l/min	VHEF-ES-B53C-G18	4106818
		G1/4	1200 l/min	VHEF-ES-B53C-G14	4106819
		G1/8	530 l/min	VHEF-ES-B53E-G18	4106820
		G1/4	900 l/min	VHEF-ES-B53E-G14	4106821
	Mechanical spring	G1/8	700 l/min	VHEF-ES-P53C-M-G18	4106810
		G1/4	1200 l/min	VHEF-ES-P53C-M-G14	4106811
		G1/8	530 l/min	VHEF-ES-P53E-M-G18	4106812
		G1/4	900 l/min	VHEF-ES-P53E-M-G14	4106813

Manually actuated directional control valves >

Selector valves VHEF-ES

Ordering – VHEF-ES, NPT thread

006 Valve function	007 Reset	008 Pneumatic connection	Standard nominal flow rate	Type	Part no.
3/2-way valve	–	1/8 NPT	750 l/min	VHEF-EST-B32-N18	4414814
		1/4 NPT	870 l/min	VHEF-EST-B32-N14	4414815
	Mechanical spring	1/8 NPT	750 l/min	VHEF-EST-M32-M-N18	4414806
		1/4 NPT	870 l/min	VHEF-EST-M32-M-N14	4414807
5/2-way valve	Mechanical spring	1/8 NPT	750 l/min	VHEF-ES-M52-M-N18	4414808
		1/4 NPT	1200 l/min	VHEF-ES-M52-M-N14	4414809
	–	1/8 NPT	750 l/min	VHEF-ES-B52-N18	4414816
		1/4 NPT	1200 l/min	VHEF-ES-B52-N14	4414817
5/3-way valve	–	1/8 NPT	700 l/min	VHEF-ES-B53C-N18	4414818
		1/4 NPT	1200 l/min	VHEF-ES-B53C-N14	4414819
		1/8 NPT	530 l/min	VHEF-ES-B53E-N18	4414820
		1/4 NPT	900 l/min	VHEF-ES-B53E-N14	4414821
	Mechanical spring	1/8 NPT	700 l/min	VHEF-ES-P53C-M-N18	4414810
		1/4 NPT	1200 l/min	VHEF-ES-P53C-M-N14	4414811
		1/8 NPT	530 l/min	VHEF-ES-P53E-M-N18	4414812
		1/4 NPT	900 l/min	VHEF-ES-P53E-M-N14	4414813

Accessories

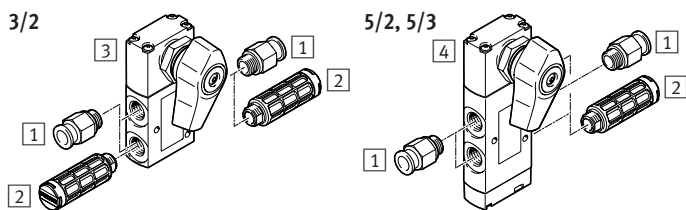

- 1 Fitting for supply air/exhaust air ports (1, 3, 5) and working ports (2, 4)
Push-in fittings QS, G thread → 293
Push-in fittings QB, NPT thread → 174
- 2 Silencer U, for exhaust air ports (3, 5)
G thread → 317
NPT thread → 174
- 3 3/2-way valve VHEF-EST...32...
- 4 5/2- or 5/3-way valve VHEF-ES...52..., VHEF-ES...53...



- Precise mechanical system
- Low actuating forces
- Ergonomic and reliable operation
- To be mounted via through-holes
- Stem actuated valves are also suitable for front panel mounting
- Sturdy thanks to metal housing and connecting thread or connector
- Reverse operation possible in some cases

Order code

001 002 003 004 005 006 007 008
 VMEF - S - - - - - - -

Legend: Mandatory entry Optional entry

001	Type
VMEF	Mechanically actuated valves
002	Actuation
S	Plunger
003	Design principle
-	Piston spool
T	Disc seat
004	Type of control
-	Directly actuated
C	Pneumatically piloted

005	Pilot air
-	Internal
Z	External
006	Valve function
M32	3/2-way valve, monostable
M52	5/2-way valve, monostable
007	Reset method for monostable valves
E	Pneumatic spring, external
M	Mechanical spring
008	Pneumatic connection
G18	G1/8 thread
G14	G1/4 thread
N18	1/8 NPT thread
N14	1/4 NPT thread

Ordering – VMEF-S, G thread

006 Valve function	004 Type of control	005 Pilot air	007 Reset	008 Connection	Standard nominal flow rate	Type	Part no.
3/2-way valves	Direct	-	Mechanical	G1/8	750 l/min	VMEF-ST-M32-M-G18	8031295
				G1/4	870 l/min	VMEF-ST-M32-M-G14	8031300
	Piloted	Internal	Mechanical	G1/8	750 l/min	VMEF-STC-M32-M-G18	8031331
				G1/4	870 l/min	VMEF-STC-M32-M-G14	8031332
		External	Mechanical	G1/8	750 l/min	VMEF-STCZ-M32-M-G18	8031335
				G1/4	870 l/min	VMEF-STCZ-M32-M-G14	8031336
5/2-way valves	Direct	-	Mechanical	G1/8	750 l/min	VMEF-S-M52-M-G18	8031297
				Pneumatic	G1/8	750 l/min	VMEF-S-M52-E-G18
			Mechanical	G1/4	1200 l/min	VMEF-S-M52-M-G14	8031302
				Pneumatic	G1/4	1200 l/min	VMEF-S-M52-E-G14
	Piloted	Internal	Mechanical	G1/4	1200 l/min	VMEF-SC-M52-M-G14 ¹⁾	8031319
				G1/8	750 l/min	VMEF-SC-M52-M-G18 ¹⁾	8031320
		External	Pneumatic	G1/4	1200 l/min	VMEF-SCZ-M52-E-G14	8031323
				G1/8	750 l/min	VMEF-SCZ-M52-E-G18	8031324
			Mechanical	G1/4	1200 l/min	VMEF-SCZ-M52-M-G14	8031327
				G1/8	750 l/min	VMEF-SCZ-M52-M-G18	8031328

1) Non-reversible

Mechanically actuated directional control valves >

Stem actuated valves VMEF-S

Ordering – VHEF-S, NPT thread

006 Valve function	004 Type of control	005 Pilot air	007 Reset	008 Connection	Standard nominal flow rate	Type	Part no.
3/2-way valves	Direct	–	Mechanical	1/8 NPT	750 l/min	VMEF-ST-M32-M-N18	8031305
				1/4 NPT	870 l/min	VMEF-ST-M32-M-N14	8031310
	Piloted	Internal	Mechanical	1/8 NPT	750 l/min	VMEF-STC-M32-M-N18	8031333
				1/4 NPT	870 l/min	VMEF-STC-M32-M-N14	8031334
		External	Mechanical	1/8 NPT	750 l/min	VMEF-STCZ-M32-M-N18	8031337
				1/4 NPT	870 l/min	VMEF-STCZ-M32-M-N14	8031338
5/2-way valves	Direct	–	Mechanical	1/8 NPT	750 l/min	VMEF-S-M52-M-N18	8031307
			Pneumatic	1/8 NPT	750 l/min	VMEF-S-M52-E-N18	8031309
			Mechanical	1/4 NPT	1200 l/min	VMEF-S-M52-M-N14	8031312
			Pneumatic	1/4 NPT	1200 l/min	VMEF-S-M52-E-N14	8031314
	Piloted	Internal	Mechanical	1/4 NPT	1200 l/min	VMEF-SC-M52-M-N14	8031321
				1/8 NPT	750 l/min	VMEF-SC-M52-M-N18	8031322
		External	Pneumatic	1/4 NPT	1200 l/min	VMEF-SCZ-M52-E-N14	8031325
				1/8 NPT	750 l/min	VMEF-SCZ-M52-E-N18	8031326
			Mechanical	1/4 NPT	1200 l/min	VMEF-SCZ-M52-M-N14	8031329
				1/8 NPT	750 l/min	VMEF-SCZ-M52-M-N18	8031330

1) Non-reversible

Accessories

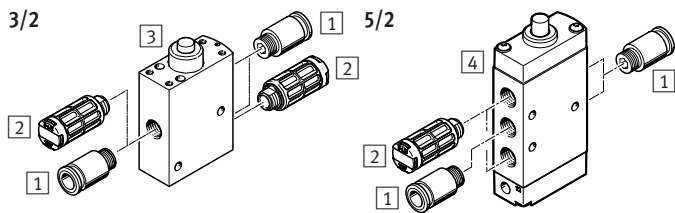

- 1 Fitting for supply air/exhaust air ports (1, 3, 5) and working ports (2, 4)
Push-in fittings QS, G thread → 293
Push-in fittings QB, NPT thread → 174
- 2 Silencer U, for exhaust air ports (3, 5)
G thread → 317
NPT thread → 174
- 3 3/2-way valve
- 4 5/2-way valve



- Precise mechanical system
- Low actuating forces
- Ergonomic and reliable operation
- To be mounted via through-holes
- Sturdy thanks to metal housing and connecting thread or connector
- Reversible

Order code

001 002 003 004 005 006 007 008
VMEF - **R** - [] - [] - []

Legend: [] Mandatory entry [] Optional entry

001	Type
VMEF	Mechanically actuated valves
002	Actuation
R	Roller lever
003	Design principle
-	Piston spool
T	Disc seat
004	Type of control
-	Directly actuated
005	Pilot air
-	Internal

006	Valve function
M32	3/2-way valve, monostable
M52	5/2-way valve, monostable
007	Reset method for monostable valves
E	Pneumatic spring, external
M	Mechanical spring
008	Pneumatic connection
G18	G1/8 thread
G14	G1/4 thread
N18	1/8 NPT thread
N14	1/4 NPT thread

Ordering – VMEF-R, G thread

006 Valve function	004 Type of control	005 Pilot air	007 Reset	008 Connection	Standard nominal flow rate	Type	Part no.
3/2-way valves	Direct	Internal	Mechanical	G1/8	750 l/min	VMEF-RT-M32-M-G18	8049239
				G1/4	870 l/min	VMEF-RT-M32-M-G14	8047095
5/2-way valves	Direct	Internal	Pneumatic	G1/8	750 l/min	VMEF-R-M52-E-G18	8047092
			Mechanical	G1/8	750 l/min	VMEF-R-M52-M-G18	8049238
			Pneumatic	G1/4	1200 l/min	VMEF-R-M52-E-G14	8047093
			Mechanical	G1/4	1200 l/min	VMEF-R-M52-M-G14	8047094

Ordering – VMEF-R, NPT thread

006 Valve function	004 Type of control	005 Pilot air	007 Reset	008 Connection	Standard nominal flow rate	Type	Part no.
3/2-way valves	Direct	Internal	Mechanical	1/8 NPT	750 l/min	VMEF-RT-M32-M-N18	8047098
				1/4 NPT	870 l/min	VMEF-RT-M32-M-N14	8047101
5/2-way valves	Direct	Internal	Pneumatic	1/8 NPT	750 l/min	VMEF-R-M52-E-N18	8047096
			Mechanical	1/8 NPT	750 l/min	VMEF-R-M52-M-N18	8047097
			Pneumatic	1/4 NPT	1200 l/min	VMEF-R-M52-E-N14	8047099
			Mechanical	1/4 NPT	1200 l/min	VMEF-R-M52-M-N14	8047100

Accessories

3/2

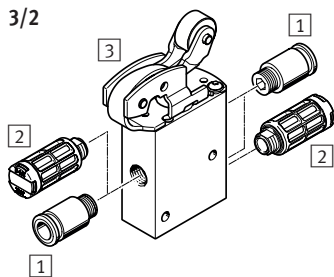

5/2

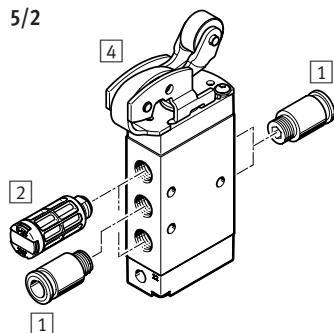

- 1 Fitting for supply air/exhaust air ports (1, 3, 5) and working ports (2, 4)
Push-in fittings QS, G thread → 293
Push-in fittings QB, NPT thread → 174
- 2 Silencer U, for exhaust air ports (3, 5)
G thread → 317
NPT thread → 174
- 3 3/2-way valve
- 4 5/2-way valve



- Precise mechanical system
- Low actuating forces
- Ergonomic and reliable operation
- To be mounted via through-holes
- Sturdy thanks to metal housing and connecting thread or connector
- Reversible

Order code

001 002 003 004 005 006 007 008
VMEF - **K** - - - - **M** -

Legend: Mandatory entry Optional entry

001	Type
VMEF	Mechanically actuated valves
002	Actuation
K	Roller lever
003	Design principle
-	Piston spool
T	Disc seat
004	Type of control
-	Directly actuated
005	Pilot air
-	Internal

006	Valve function
M32	3/2-way valve, monostable
M52	5/2-way valve, monostable
007	Reset method for monostable valves
M	Mechanical spring
008	Pneumatic connection
G18	G1/8 thread
G14	G1/4 thread
N18	1/8 NPT thread
N14	1/4 NPT thread

Ordering – VHEF-K, G thread

006 Valve function	004 Type of control	005 Pilot air	007 Reset	008 Connection	Standard nominal flow rate	Type	Part no.
3/2-way valves	Direct	Internal	Mechanical	G1/8	750 l/min	VMEF-KT-M32-M-G18	8049241
				G1/4	870 l/min	VMEF-KT-M32-M-G14	8047103
5/2-way valves	Direct	Internal	Mechanical	G1/8	750 l/min	VMEF-K-M52-M-G18	8049240
				G1/4	1200 l/min	VMEF-K-M52-M-G14	8047102

Ordering – VHEF-K, NPT thread

006 Valve function	004 Type of control	005 Pilot air	007 Reset	008 Connection	Standard nominal flow rate	Type	Part no.
3/2-way valves	Direct	Internal	Mechanical	1/8 NPT	750 l/min	VMEF-KT-M32-M-N18	8047105
				1/4 NPT	870 l/min	VMEF-KT-M32-M-N14	8047107
5/2-way valves	Direct	Internal	Mechanical	1/8 NPT	750 l/min	VMEF-K-M52-M-N18	8047104
				1/4 NPT	1200 l/min	VMEF-K-M52-M-N14	8047106

Accessories

3/2

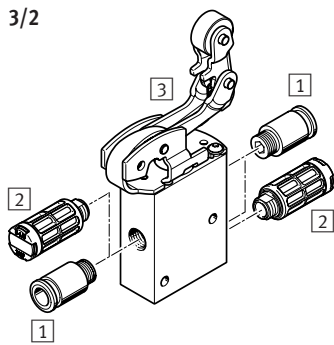

5/2

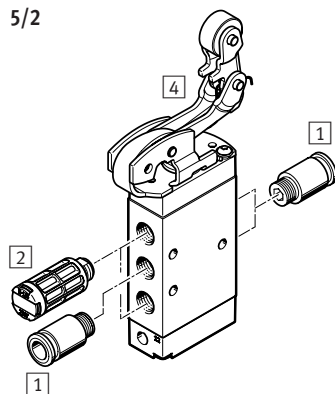

- 1 Fitting for supply air/exhaust air ports (1, 3, 5) and working ports (2, 4)
Push-in fittings QS, G thread → 293
Push-in fittings QB, NPT thread → 174
- 2 Silencer U, for exhaust air ports (3, 5)
G thread → 317
NPT thread → 174
- 3 3/2-way valve
- 4 5/2-way valve

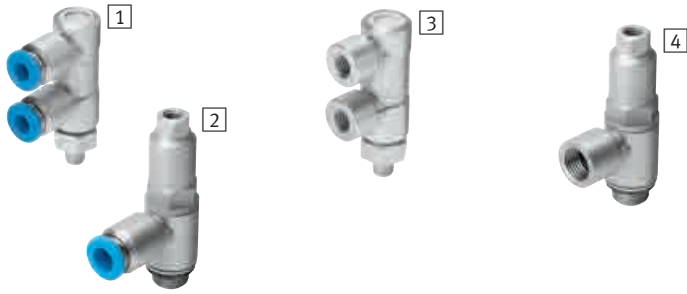

- Controlled, piloted non-return function
- Manual exhausting
- Rotatable when installed
- Push-in connector
Flow rate 130 ... 1400 l/min
- Female thread
Flow rate 130 ... 1600 l/min

- 1 HGL-M5-QS-4
- 2 HGL-...-QS
- 3 HGL-M5-B
- 4 HGL-...-B

Order code

001 002 003 004
HGL - -

Legend: Mandatory entry Optional entry

001	Type
HGL	Check valve, piloted
002	Pneumatic connection 2
M5	Male thread M5
1/8	Male thread G1/8
1/4	Male thread G1/4
3/8	Male thread G3/8
1/2	Male thread G1/2
003	Pneumatic connection 1
-	Connection size as for connection 2, female thread
QS-4	Push-in connector for tubing O.D. 4 mm
QS-6	Push-in connector for tubing O.D. 6 mm
QS-8	Push-in connector for tubing O.D. 8 mm
QS-10	Push-in connector for tubing O.D. 10 mm
QS-12	Push-in connector for tubing O.D. 12 mm

004	Generation
-	Without
B	Optimised function

Ordering

	002 Pneumatic connection 2	003 Pneumatic connection 1	Pilot air connection 21	Standard nominal flow rate q _N in flow direction at 6 bar → 5 bar [l/min]	Standard flow rate q _n in flow direction at 6 bar → 0 bar [l/min]	Type	Part no.
Push-in/threaded connection							
1	M5	QS-4	QS-4	130	200	HGL-M5-QS-4	530038
2	G1/8	QS-4	M5	200	300	HGL-1/8-QS-6	530039
	G1/8	QS-6	M5	270	400	HGL-1/8-QS-6	530040
	G1/4	QS-8	G1/8	390	640	HGL-1/4-QS-8	530041
	G1/4	QS-10	G1/8	400	670	HGL-1/4-QS-10	530042
	G3/8	QS-8	G1/4	830	1200	HGL-3/8-QS-8	530043
	G3/8	QS-10	G1/4	890	1300	HGL-3/8-QS-10	530044
	G1/2	QS-12	G3/8	1400	2100	HGL-1/2-QS-12	530045
Threaded connection at both ends							
3	M5	M5	M5	130	200	HGL-M5-B	530029
4	G1/8	G1/8	M5	300	430	HGL-1/8-B	530030
	G1/4	G1/4	G1/8	550	680	HGL-1/4-B	530031
	G3/8	G3/8	G1/4	1100	1500	HGL-3/8-B	530032
	G1/2	G1/2	G3/8	1600	2100	HGL-1/2-B	530033

Shut-off valves > Shut-off valves and ball valves >

Hand slide valves VBOH

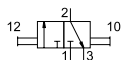

- Can be used as a shut-off function for pressurising and exhausting compressed air systems, e.g. upstream of service unit combinations, for air guns or for exhausting pneumatic cylinders
- Non-overlapping, so no pressure losses when switching
- Minimal installation effort
- Standard nominal flow rate 236 ... 7691 l/min
- Operating pressure -0.95 ... +12 bar
- Exclusive design

Order code

001 002 003 004
VBOH - **32** - -

Legend: Mandatory entry Optional entry

001	Type
VBOH	Hand slide valve

002	Valve function
32	3/2-way valve, bistable

003	Pneumatic connection 1
M5	Female thread M5
G18	Female thread G1/8
G14	Female thread G1/4
G38	Female thread G3/8
G12	Female thread G1/2
G34	Female thread G3/4

004	Pneumatic connection 2
-	Same size as pneumatic connection 1

Ordering

003 Pneumatic connection 1	004 Pneumatic connection 2	Nominal width [mm]	Standard nominal flow rate qnN [l/min]	Type	Part no.
M5	M5	3.6	236	VBOH-32-M5	1609969
G1/8	G1/8	5.7	777	VBOH-32-G18	1558073
G1/4	G1/4	8.4	1675	VBOH-32-G14	1302994
G3/8	G3/8	9.9	2201	VBOH-32-G38	1482679
G1/2	G1/2	12.1	3420	VBOH-32-G12	1587988
G3/4	G3/4	19.3	7691	VBOH-32-G34	1629664



- Fast, controllable non-return function
- Prevents pneumatic drives from dropping down in the event of a loss of compressed air
- With hand lever
- Pipe thread to ISO 228-1

Order code

001 002 003
QH -

Legend: Mandatory entry Optional entry

001	Type
QH	Ball valve

003	Pneumatic connection 2
-	Same size as pneumatic connection 1

002	Pneumatic connection 1
1/4	Female thread G1/4
3/8	Female thread G3/8
1/2	Female thread G1/2
3/4	Female thread G3/4
1	Female thread G1
1 1/2	Female thread G1 1/2

Ordering – Basic design

002 Pneumatic connection 1	003 Pneumatic connection 2	Nominal width [mm]	Standard nominal flow rate q _N [l/min]	Type	Part no.
G1/4	G1/4	10	3400	QH-1/4	9541
G3/8	G3/8	10	7500	QH-3/8	9542
G1/2	G1/2	15	11500	QH-1/2	9543
G3/4	G3/4	20	21000	QH-3/4	9544
G1	G1	25	33000	QH-1	9545
G1 1/2	G1 1/2	40	84000	QH-1 1/2	6837

Flow control valves >

One-way flow control valves GRLA, GRLZ



1



2

- Sturdy metal design
- Can be swivelled 360° around the screw-in axis after mounting
- Push-in connector
- Flow rate 100 ... 1580 l/min

- 1 GRLA-QS-D/GRLZ-QS-D: with slotted head screw
- 2 GRLA-QS-RS-D: with knurled screw

Order code – Basic design

001 002 003 004 005 006 007
 - - - - - -

Legend: Mandatory entry Optional entry

001	Type
GRLA	One-way flow control valve for exhaust air, elbow outlet
GRLZ	One-way flow control valve for supply air, elbow outlet
002	Pneumatic connection 2
M5	Male thread M5
1/8	Male thread G1/8
1/4	Male thread G1/4
3/8	Male thread G3/8
1/2	Male thread G1/2
003	Pneumatic connection 1, connection type
QS	Push-in connector

004	Pneumatic connection 1, tubing O.D. [mm]
...	3, 4, 6, 8, 10, 12
005	Adjusting element
-	Slotted head screw
RS	Knurled screw
006	Flow rate characteristic
-	None
MF	Medium flow
007	Generation
D	D series

Product options

One-way flow control valves

GRLSA Elbow outlet, with rotary knob
 GR Straight design
 CRGRLA Stainless steel

Pneumatic connection

M3 Male thread M3
 QS-3 Push-in connector 3 mm

Flow rate characteristic

LF Low flow



Configurable product

This product and all its product options can be ordered online via the configurator:

→ www.festo.com/catalogue/grla

One-way flow control valves GRLA, GRLZ

Ordering – Basic design

Pneumatic connection		Standard nominal flow rate qnN at 6 bar → 5 bar		Standard flow rate qn at 6 bar → 0 bar		Type	Part no.
		In flow control direction	In non-return direction	In flow control direction	In non-return direction		
002	003/004	[l/min]	[l/min]	[l/min]	[l/min]		
001 GRLA: for exhaust air, 005 With slotted head screw							
M5	QS-3	100	60 ... 100	145	150 ... 170	GRLA-M5-QS-3-D	193137
	QS-4	110	65 ... 110	165	140 ... 160	GRLA-M5-QS-4-D	193138
	QS-6	115	70 ... 110	185	145 ... 170	GRLA-M5-QS-6-D	193139
G1/8	QS-3	130	100 ... 130	180	200 ... 220	GRLA-1/8-QS-3-D	193142
	QS-4	160	120 ... 190	250	270 ... 300	GRLA-1/8-QS-4-D	193143
	QS-6	185	160 ... 240	370	330 ... 390	GRLA-1/8-QS-6-D	193144
	QS-8	215	175 ... 250	400	330 ... 410	GRLA-1/8-QS-8-D	193145
G1/4	QS-6	400	290 ... 420	600	570 ... 680	GRLA-1/4-QS-6-D	193146
	QS-8	475	325 ... 500	720	610 ... 760	GRLA-1/4-QS-8-D	193147
	QS-10	480	345 ... 500	760	630 ... 790	GRLA-1/4-QS-10-D	193148
G3/8	QS-6	495	320 ... 495	740	840 ... 890	GRLA-3/8-QS-6-D	193149
	QS-8	820	450 ... 850	1300	1080 ... 1420	GRLA-3/8-QS-8-D	193150
	QS-10	900	540 ... 975	1400	1160 ... 1620	GRLA-3/8-QS-10-D	193151
G1/2	QS-12	1580	925 ... 1605	2220	1910 ... 2500	GRLA-1/2-QS-12-D	193152
001 GRLA: for exhaust air, 005 With slotted head screw, 006 Mid flow							
G1/8	QS-6	400	290 ... 420	600	570 ... 680	GRLA-1/8-QS-6-MF-D	537075
	QS-8	475	325 ... 500	720	610 ... 760	GRLA-1/8-QS-8-MF-D	537076
001 GRLA-RS: for exhaust air, 005 With knurled screw							
M5	QS-3	100	60 ... 100	145	150 ... 170	GRLA-M5-QS-3-RS-D	197576
	QS-4	110	65 ... 110	165	140 ... 160	GRLA-M5-QS-4-RS-D	197577
	QS-6	115	70 ... 110	185	145 ... 170	GRLA-M5-QS-6-RS-D	197578
G1/8	QS-3	130	100 ... 130	180	200 ... 220	GRLA-1/8-QS-3-RS-D	197579
	QS-4	160	120 ... 190	250	270 ... 300	GRLA-1/8-QS-4-RS-D	197580
	QS-6	185	160 ... 240	370	330 ... 390	GRLA-1/8-QS-6-RS-D	197581
	QS-8	215	175 ... 250	400	330 ... 410	GRLA-1/8-QS-8-RS-D	534337
G1/4	QS-6	400	290 ... 420	600	570 ... 680	GRLA-1/4-QS-6-RS-D	534338
	QS-8	475	325 ... 500	720	610 ... 760	GRLA-1/4-QS-8-RS-D	534339
	QS-10	480	345 ... 500	760	630 ... 790	GRLA-1/4-QS-10-RS-D	534340
G3/8	QS-6	495	320 ... 495	740	840 ... 890	GRLA-3/8-QS-6-RS-D	534341
	QS-8	820	450 ... 850	1300	1080 ... 1420	GRLA-3/8-QS-8-RS-D	534342
	QS-10	900	540 ... 975	1400	1160 ... 1620	GRLA-3/8-QS-10-RS-D	534343
G1/2	QS-12	1580	925 ... 1605	2220	1910 ... 2500	GRLA-1/2-QS-12-RS-D	534344

Pneumatic connection		Standard nominal flow rate qnN at 6 bar → 5 bar		Standard flow rate qn at 6 bar → 0 bar		Type	Part no.
		In flow control direction	In non-return direction	In flow control direction	In non-return direction		
002	003/004	[l/min]	[l/min]	[l/min]	[l/min]		
001 GRLZ: for supply air, 005 With slotted head screw							
M5	QS-3	100	60 ... 100	135	130 ... 160	GRLZ-M5-QS-3-D	193153
	QS-4	110	65 ... 110	160	150 ... 180	GRLZ-M5-QS-4-D	193154
	QS-6	115	70 ... 110	170	160 ... 200	GRLZ-M5-QS-6-D	193155
G1/8	QS-3	130	100 ... 130	200	180 ... 200	GRLZ-1/8-QS-3-D	193156
	QS-4	160	120 ... 190	300	260 ... 290	GRLZ-1/8-QS-4-D	193157
	QS-6	185	160 ... 240	340	390 ... 460	GRLZ-1/8-QS-6-D	193158
	QS-8	215	175 ... 250	370	390 ... 470	GRLZ-1/8-QS-8-D	193159

07

Valve terminals

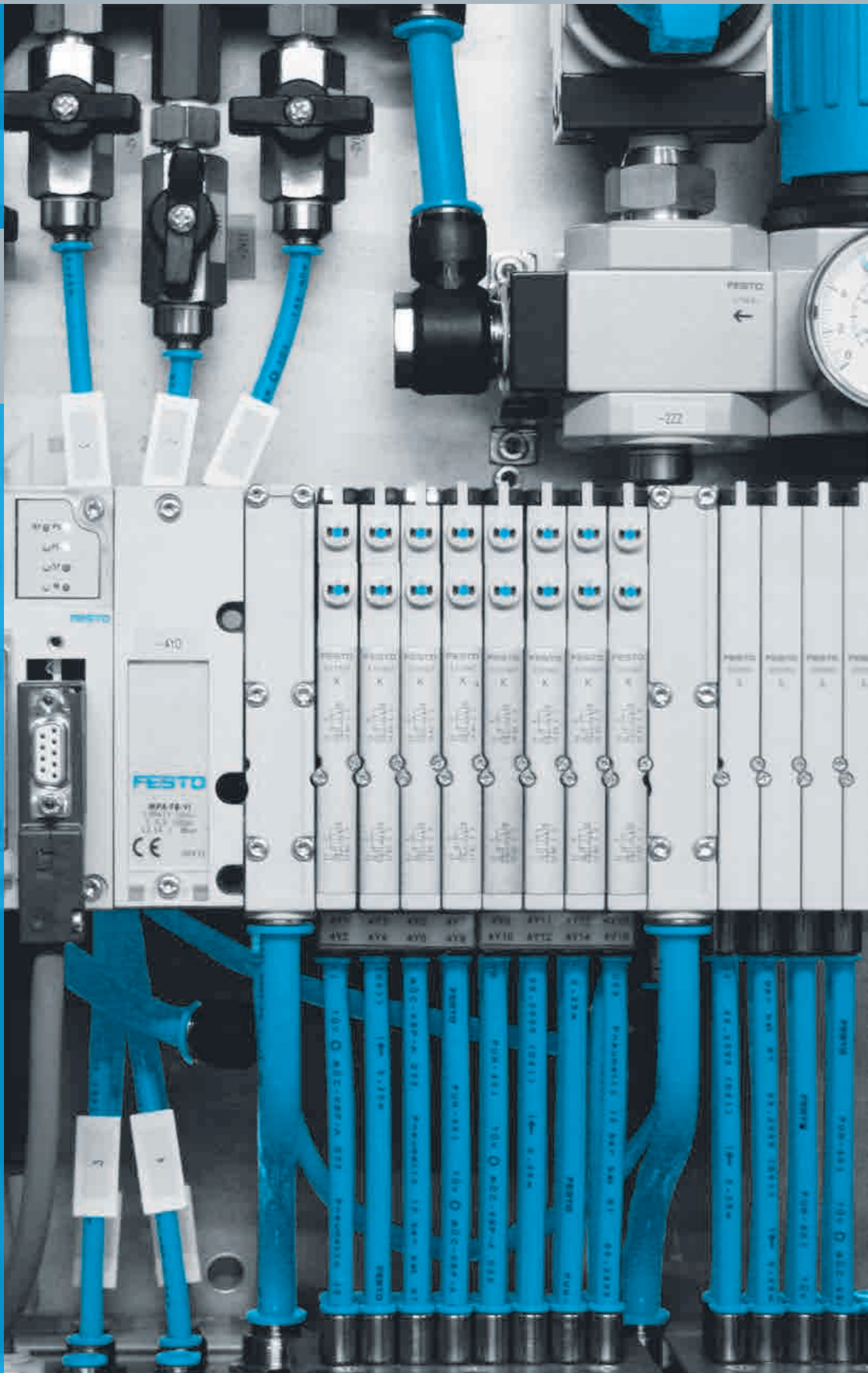

Highlights

Contents



Valve manifolds with individual electrical connection

VTUG-S

- + Compact universal series
- + High flow rate

→ 206

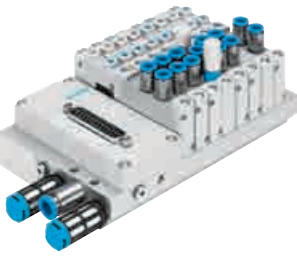

Valve terminals with multi-pin plug or fieldbus connection

VTUG

- + Energy-efficient thanks to reverse operation and targeted pressure reduction
- + Especially suitable for control cabinet installation

→ 208



Valve terminals

MPA-S

- + Extremely flexible
- + Open to PROFIBUS-DP, INTERBUS®, CANopen, DeviceNet®, CC-LINK®

→ 212

Product overview _____ 196

Valve terminals VTSA _____ 202

Valve manifolds VTUG-S with individual electrical connection _____ 206

Valve terminals VTUG with multi-pin or fieldbus connection _____ 208

Valve manifolds VTUS _____ 210

Valve terminals MPA-S with CPX terminal _____ 212

Automation system CPX-AP-I _____ 214

Product overview

Software-Tools

Product Finder for valve terminals



Find the right valve terminal quickly with the help of the Product Finder.

Start the Product Finder by clicking on the blue button "Product Finder" under "Products". Select the technical features on the left-hand side step-by-step; the selection of suitable products on the right-hand side is automatically updated to reflect the chosen technical features.

The use of logic checks ensures that only correct configurations are available for selection.

This tool can be found

- on our website at www.festo.com/catalogue by clicking on the blue button "Product Finder".

Standards-based valve terminals





**Valve terminals
VTSA**



**Valve terminals
VTSA-NPT**



Width	18 mm, 26 mm, 42 mm, 52 mm, 65 mm	18 mm, 26 mm, 42 mm, 52 mm, 65 mm
Valve function	2x2/2-way, single solenoid, closed, 2x3/2-way, single solenoid, closed, 2x3/2-way, single solenoid, open, 2x3/2-way, single solenoid, open/closed, 5/2-way, double solenoid, 5/2-way, double solenoid dominant, 5/2-way, single solenoid, 5/2-way, single solenoid, safety function, 5/3-way, pressurised, 5/3-way, exhausted, 5/3-way, closed, 5/3-way, connection 2 pressurised, 4 exhausted	2x2/2-way, single solenoid, closed, 2x3/2-way, single solenoid, closed, 2x3/2-way, single solenoid, open, 2x3/2-way, single solenoid, open/closed, 5/2-way, double solenoid, 5/2-way, double solenoid dominant, 5/2-way, single solenoid, 5/2-way, single solenoid, safety function, 5/3-way, pressurised, 5/3-way, exhausted, 5/3-way, closed, 5/3-way, connection 2 pressurised, 4 exhausted
Max. standard nominal flow rate	550 l/min at 18 mm, 1100 l/min at 26 mm, 1300 l/min at 42 mm, 2900 l/min at 52 mm, 4000 l/min at 65 mm	550 l/min at 18 mm, 1100 l/min at 26 mm, 1300 l/min at 42 mm, 2900 l/min at 52 mm, 4000 l/min at 65 mm
Max. no. of valve positions	32	32
Electrical actuation	Ethernet, fieldbus, multi-pin plug, integrated controller	Ethernet, fieldbus, multi-pin plug, integrated controller
Valve terminal design	Modular, valve sizes can be mixed	Modular, valve sizes can be mixed
Description	<ul style="list-style-type: none"> • Conforms to ISO 15407-2/ISO 5599-2 • Multi-pin plug connection or fieldbus connection via the CPX system • Five valve sizes can be combined on one valve terminal • Integratable safety functions 	<ul style="list-style-type: none"> • Conforms to ISO 15407-2/ISO 5599-2 • Multi-pin plug connection or fieldbus connection via the CPX system • Five valve sizes can be combined on one valve terminal • Integratable safety functions
→ Page/online	202	202

Universal valve terminals



	 Valve manifolds VTUG-S	 Valve terminals with multi-pin plug/fieldbus connection VTUG	 Valve manifolds VTUS
Width	10 mm, 14 mm, 18 mm	10 mm, 14 mm, 18 mm	21 mm, 26.5 mm, 31 mm
Valve function	2x3/2-way, single solenoid, closed, 2x3/2-way, single solenoid, open, 2x3/2-way, single solenoid, open/closed, 5/2-way, double solenoid, 5/2-way, single solenoid, 5/3-way, pressurised, 5/3-way, exhausted, 5/3-way, closed	2x3/2-way, single solenoid, closed, 2x3/2-way, single solenoid, open, 2x3/2-way, single solenoid, open/closed, 3/2-way, single solenoid, closed, 3/2-way, single solenoid, open, 5/2-way, double solenoid, 5/2-way, single solenoid, 5/3-way, pressurised, 5/3-way, exhausted, 5/3-way, closed	2x3/2-way, single solenoid, closed, 2x3/2-way, single solenoid, open, 2x3/2-way, single solenoid, open/closed, 3/2-way, single solenoid, closed, 3/2-way, single solenoid, open, 5/2-way, double solenoid, 5/2-way, single solenoid, 5/3-way, pressurised, 5/3-way, exhausted, 5/3-way, closed
Max. standard nominal flow rate	380 l/min at 10 mm, 780 l/min at 14 mm, 1380 l/min at 18 mm	330 l/min at 10 mm, 630 l/min at 14 mm, 1200 l/min at 18 mm	
Max. no. of valve positions	16	24	16
Electrical actuation	Individual connection	Individual connection, fieldbus, multi-pin plug, IO-Link®, I-Port, AP interface	Individual connection
Valve terminal design	Fixed grid	Fixed grid	Fixed grid
Description	<ul style="list-style-type: none"> • Compact with small valves VUUG • Connection technology easy to change via the E-box • Wide range of valve functions • Also with semi in-line valves 	<ul style="list-style-type: none"> • Low-cost fixed grid • Extremely easy assembly • Exchangeable electrical actuation • IO-Link® capable • Valves VUUG with individual electrical connection can be integrated • Also available with pneumatic multiple connector plate • Part of the VG series • Energy-efficient thanks to reverse operation and targeted pressure reduction • Optimised and space-saving variant available for installation in control cabinets • Variants with hot-swap connections: valves can be replaced during operation 	<ul style="list-style-type: none"> • Robust valves with long service life VUUS • Individual electrical connection • Pilot air supply in the manifold rail • Comprehensive range of accessories
→ Page/online	206	208	210

Product overview

Universal valve terminals



	 Valve terminals VTSA-F	 Valve terminals VTSA-F-NPT	 Valve terminals VTSA-F-CB
Width	18 mm, 26 mm, 42 mm, 52 mm, 65 mm	18 mm, 26 mm, 42 mm, 52 mm, 65 mm	18 mm, 26 mm, 42 mm, 52 mm
Valve function	2x2/2-way, single solenoid, closed, 2x3/2-way, single solenoid, closed, 2x3/2-way, single solenoid, open, 2x3/2-way, single solenoid, open/closed, 5/2-way, double solenoid, 5/2-way, double solenoid dominant, 5/2-way, single solenoid, 5/2-way, single solenoid, safety function, 5/3-way, pressurised, 5/3-way, exhausted, 5/3-way, closed, 5/3-way, connection 2 pressurised, 4 exhausted	2x2/2-way, single solenoid, closed, 2x3/2-way, single solenoid, closed, 2x3/2-way, single solenoid, open, 2x3/2-way, single solenoid, open/closed, 5/2-way, double solenoid, 5/2-way, double solenoid dominant, 5/2-way, single solenoid, 5/2-way, single solenoid, safety function, 5/3-way, pressurised, 5/3-way, exhausted, 5/3-way, closed, 5/3-way, connection 2 pressurised, 4 exhausted	2x2/2-way, single solenoid, closed, 2x3/2-way, single solenoid, closed, 2x3/2-way, single solenoid, open, 2x3/2-way, single solenoid, open/closed, 5/2-way, double solenoid, 5/2-way, double solenoid dominant, 5/2-way, single solenoid, 5/3-way, pressurised, 5/3-way, exhausted, 5/3-way, closed, 5/3-way, connection 2 pressurised, 4 exhausted
Max. standard nominal flow rate	700 l/min at 18 mm, 1350 l/min at 26 mm, 1860 l/min at 42 mm, 2900 l/min at 52 mm, 4000 l/min at 65 mm	700 l/min at 18 mm, 1350 l/min at 26 mm, 1860 l/min at 42 mm, 2900 l/min at 52 mm, 4000 l/min at 65 mm	700 l/min at 18 mm, 1350 l/min at 26 mm
Max. no. of valve positions	32	32	
Electrical actuation	Ethernet, fieldbus, multi-pin plug, integrated controller	Ethernet, fieldbus, multi-pin plug, integrated controller	Fieldbus
Valve terminal design	Modular, valve sizes can be mixed	Modular, valve sizes can be mixed	Modular, valve sizes can be mixed
Description	<ul style="list-style-type: none"> Flow rate-optimised valve terminal VTSA Linking with increased flow rates Functions like standard valve terminals VTSA 	<ul style="list-style-type: none"> Flow rate-optimised valve terminal VTSA Linking with increased flow rates Functions like standard valve terminals VTSA 	<ul style="list-style-type: none"> Previous external cabling is now unnecessary, while the installation space remains the same Up to 96 valve addresses and up to four voltage zones, three of which can be safely shut off For applications with increased safety requirements such as manual work stations Five valve sizes can be combined on one valve terminal
→ Page/online	202	202	vtsa-f

Universal valve terminals

	 Valve terminals MPA-S	 Valve terminals MPA-L	 Valve terminals, Compact Performance CPV10, CPV14, CPV18
Width	10 mm, 14 mm, 20 mm	10 mm, 14 mm, 20 mm	10 mm, 14 mm, 18 mm, 18 mm
Valve function	2/2-way, single solenoid, closed, 2x3/2-way, single solenoid, closed, 2x3/2-way, single solenoid, open, 2x3/2-way, single solenoid, open/closed, 3-way proportional pressure regulator, 3/2-way, single solenoid, closed, 3/2-way, single solenoid, open, 5/2-way, double solenoid, 5/2-way, single solenoid, 5/3-way, pressurised, 5/3-way, exhausted, 5/3-way, closed	2/2-way, single solenoid, closed, 2x3/2-way, single solenoid, closed, 2x3/2-way, single solenoid, open, 2x3/2-way, single solenoid, open/closed, 3/2-way, single solenoid, closed, 3/2-way, single solenoid, open, 5/2-way, double solenoid, 5/2-way, single solenoid, 5/3-way, pressurised, 5/3-way, exhausted, 5/3-way, closed	2x2/2-way, single solenoid, closed, 2x2/2-way, single solenoid, open/closed, 2x3/2-way, single solenoid, open, 2x3/2-way, single solenoid, open/closed, 3/2-way, single solenoid, closed, 3/2-way, single solenoid, open, 5/2-way, double solenoid, 5/2-way, single solenoid, vacuum generator, vacuum generator + 2/2-way, single solenoid, closed
Max. standard nominal flow rate	360 l/min at 10 mm, 550 l/min at 14 mm, 700 l/min at 20 mm	360 l/min at 10 mm, 670 l/min at 14 mm, 870 l/min at 20 mm	400 l/min at 10 mm, 800 l/min at 14 mm, 1600 l/min at 18 mm
Max. no. of valve positions	24, 32, 64, 8	32	8
Electric actuation	AS-Interface, fieldbus, multi-pin plug	Fieldbus, multi-pin plug, IO-Link®, I-Port, AP interface	AS-Interface®, CPI installation system, individual connection, fieldbus, multi-pin plug
Valve terminal design	Modular, valve sizes can be mixed	Valve sizes can be mixed	Fixed grid
Description	<ul style="list-style-type: none"> • Valve terminals for universal applications • High-performance valves in a sturdy metal housing • Metal linking • Two valve sizes can be combined • Excellent communication thanks to serial linking • Fieldbus connection via CPX • Max. 128 valves 	<ul style="list-style-type: none"> • Maximum modularity • Individual granularity • Polymer sub-base • 3 valve sizes • Tamper-proof fixed flow restrictor • Fieldbus connection via CPX • IO-Link® capable 	<ul style="list-style-type: none"> • Maximum performance in the smallest of spaces • Three sizes • Wide range of connection and mounting options • Multi-pin or fieldbus control • IO-Link® capable
→ Page/online	212	mpa-l	cpv

Product overview

Electrical peripherals

	 Automation systems CPX-AP-I	 Terminal CPX	 Fieldbus modules CTEU
Protocol	IO-Link		AS-Interface, CANopen, CC-Link, CPI-B, DeviceNet, EtherCAT, EtherNet/IP, PROFINET, Modbus® TCP, PROFIBUS DP
Electrical actuation		Fieldbus, integrated controller	
Max. address volume for inputs	244 ... 2048 Byte	64 Byte	2 ... 64 Byte
Max. address volume for outputs	244 ... 2048 Byte	64 Byte	2 ... 64 Byte
Parameterisation		Diagnostic behaviour, failsafe response, forcing of channels, signal setup	Activate diagnostics, diagnostic behaviour, failsafe and idle response, failsafe response, IO-Link® mode, watchdog disable, watchdog enable
Degree of protection	IP65, IP67	IP65, IP67	IP65, IP67
Nominal operating voltage DC		24 V	24 ... 30 V
Operating voltage range DC		18 ... 30 V	18 ... 31.6 V
Description	<ul style="list-style-type: none"> • Simple integration into the controller of your choice: PROFINET, PROFIBUS, EtherCAT®, EtherNet/IP, ModbusTCP • Powerful remote I/O system that flexibly links 80 modules at a data rate of 200 Mbaud in real time • Cable lengths of up to 50 m between every module enable vast system dimensions • Real-time capability and deterministic system behaviour enable cycle times of up to 250 µs • The IO-Link® master and parameterisation software enable simple integration of any IO-Link® devices • Ethernet performance up to the valve terminal and digital as well as analogue input/output modules • Seamless connectivity along with advanced diagnostics option increase the machine availability and productivity 	<ul style="list-style-type: none"> • Automation platform • Open to all common fieldbus protocols and Ethernet • Integrated diagnostic and maintenance functions • Applicable as stand-alone remote I/O or with valve terminals MPA-S, MPA-L, VTSA/VTSA-F • Choice of polymer or metal interlinking block with individual linking • Analogue inputs and outputs, 2-way/4-way, optionally with HART protocol 	<ul style="list-style-type: none"> • For valve terminals VTUB-12, VTUG, MPA-L, CPV, VTOC • Can be expanded into installation system CTEL • Fieldbus-typical LEDs, interfaces and switching elements • Isolated power supply for electronics and valves
→ Page/online	214	cpx	cteu

Customised components – for your specific requirements



Valve terminals with customised designs

Can't find the valve terminal you need in our catalogue?

We can offer you customised components that are tailored to your specific requirements.

Common product modifications:

- Coatings for special ambient conditions
- Customised cables: length, pin allocation, pre-assembled with plug
- Modified actuating elements
- Modified connecting thread
- Modified valve sub-bases

Many additional variants are possible.

Ask your Festo sales engineer, who will be happy to help:

→ www.festo.com/contact

Standards-based valve terminals >

Valve terminals VTSA

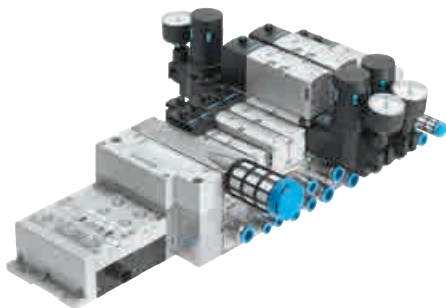

- Sturdy and flexible valve terminal
- Widths 18 and 26 mm: ISO 15407-2, widths 42 and 52 mm: ISO 5599-2
- Widths 18 mm, 26 mm, 42 mm and 52 mm can be combined on one valve terminal without an adapter
- Complete and standardised valve range
- Wide range of vertical stacking modules: pressure regulator, flow control, vertical pressure shut-off plate, etc.
- Integrated safety functions
- Flow rate: 550 ... 2900 l/min
- Flow-optimised version VTSA-F: 700 ... 4000 l/min
- High pressure range: -0.9 ... 10 bar
- All pneumatic connections can also be supplied with an NPT thread

Key features

Innovative

- High-performance valves in a sturdy metal housing
- Five valve sizes on one valve terminal (width 65 mm with adapter)
- Standardised from the multi-pin plug to the fieldbus connection and control block
- Dream team: fieldbus valve terminal suitable for electrical peripherals CPX. This means:
 - Forward-looking internal communication system for controlling the valves and CPX modules
 - Four valve sizes on one valve terminal without adapters
- Valve functions for integration in control architectures of higher categories to EN ISO 13849-1

Flexible

- Modular system offering a range of configuration options
- Expandable with up to 32 solenoid coils
- Conversions and extensions are possible at any time
- Integration of innovative function modules possible
- Flexible air supply and variable pressure zones
- Reverse operation
- High pressure range -0.9 ... 10 bar, flow range 550 ... 4000 l/min
- Wide range of valve functions
- Valve supply 24 V DC or 110 V AC

Reliable

- Sturdy and durable metal components
 - Valves
 - Manifold sub-bases
 - Seals
- Fast troubleshooting thanks to LEDs on the valves and diagnostics via fieldbus
- Reliable servicing thanks to valves that can be replaced quickly and easily
- Manual override, either non-detenting, non-detenting/detenting or covered
- Durable thanks to tried-and-tested piston spool valves
- Large and durable labelling system
- 100% duty cycle

Easy to install

- Ready-to-install and tested unit
- Reduced selection, ordering, installation and commissioning costs
- Secure mounting on wall or H-rail
- Manifold sub-bases can be extended using four screws, sturdy duct separation on metal support

Electrical connection options

Multi-pin plug connection

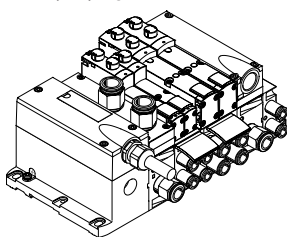

Control signals from the controller to the valve terminal are transmitted via a pre-assembled multi-wire connecting cable or a self-assembled multi-pin plug connection, which substantially reduces installation time. The valve terminals can be equipped with max. 32 valves with max. 32 solenoid coils.

Versions

- Multi-pin plug connection with terminal strip (spring-loaded terminal), 24 V DC or 110 V AC
- Pre-assembled connecting cable, 24 V DC
- Sub-D plug for assembly by the user, 37-pin, 24 V DC
- Round plug M23, 19-pin, 24 V DC

AS-Interface® connection

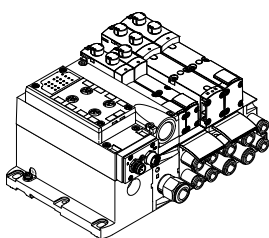

A special feature of the AS-Interface® is the simultaneous transmission of data and supply power via a two-wire cable. The encoded cable profile prevents connection with incorrect polarity.

The valve terminal with AS-Interface® is available in the following versions:

- With 1 to 8 modular valve positions (max. 8 solenoid coils). This corresponds to 1 to 8 VTSA valves.
- With all available valve functions.

The connection technology used for the inputs can be selected as with CPX: M8, M12, quick connector, Sub-D, spring-loaded terminal (terminals to IP20).

Key features

Electrical connection options

Fieldbus connection via the CPX system

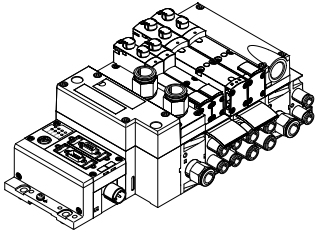

An integrated fieldbus node manages the communications connection with a higher-order PLC. This enables a space-saving pneumatic and electronic solution.

Valve terminals with fieldbus interfaces from the CPX system can be configured with up to 16 manifold sub-bases. With 2 solenoid coils per connection, up to 32 solenoid coils can thus be actuated.

Versions:

PROFIBUS, INTERBUS®, DeviceNet®, CANopen, CC-LINK®, EtherNet/IP, EtherCAT, Modbus® TCP, PROFINET, POWERLINK, Sercos III

Control block connection via the CPX system

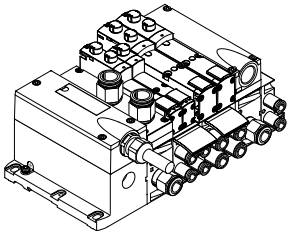

A controller integrated in the Festo valve terminal enables the construction of stand-alone control units with protection to IP65 without a control cabinet thanks to two different operating modes.

In the slave operating mode, these valve terminals can be used for intelligent preprocessing and are therefore ideal modules for designs using decentralised intelligence.

In the master operating mode, terminal groups can be designed with many options and functions that can autonomously control a medium-sized machine/system.

CP string extension

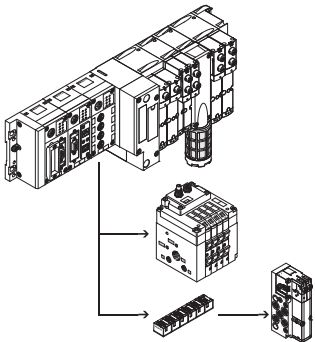

The optional CP string extension enables additional valve terminals and I/O modules to be connected to the fieldbus node of the CPX terminal on up to four CP strings. Different input and output modules as well as valve terminals MPA-S and CPV can be connected.

The maximum length of the CP string extension is 10 metres, which means that the extension modules can be mounted directly on-site. All the required electrical signals are transmitted via the CP cable, which in turn means that no further installation is needed on the extension module.

One CP string offers:

- 32 input signals
- 32 output signals for output modules 24 V DC or solenoid coils
- Logic and sensor supply for the input modules
- Load voltage supply for the valve terminals
- Logic supply for the output module

Control block with safety function,
width 26 mm

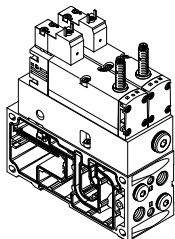

These valves are used for special applications, for example for:

- Protecting against unexpected start-up
- Safe reversing
- Drives in manually loaded devices

This control block is suitable for use as a press safety valve to EN 962.

This valve is a safety device in accordance with the Machinery Directive 2006/42/EC.

Standards-based valve terminals >

Valve terminals VTSA

Key features

Modular pneumatic peripherals

The modular design of the VTSA/VTSA-F enables maximum flexibility right from the planning stage and offers maximum ease of service in operation.

The system consists of manifold sub-bases and valves.

The manifold sub-bases are screwed together and thus form the support system for the valves.

Inside the manifold sub-bases are the ducts for supplying compressed air to and exhausting from the valves on the terminal as well as the working ports for the pneumatic cylinders for each valve.

Each manifold sub-base is connected to the next using four screws.

Individual valve terminal sections can be isolated and further blocks easily inserted by loosening these screws. This ensures that the valve terminal can be rapidly and reliably extended.

Basic system modularity

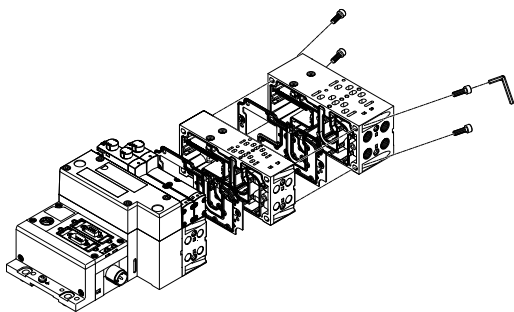

Valve modularity

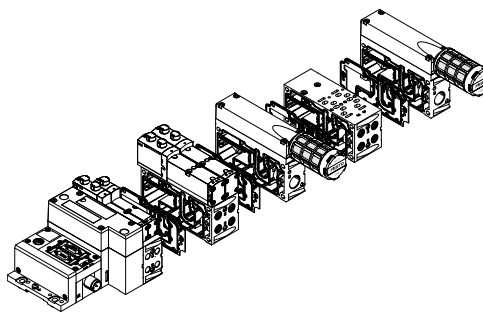

Modular electrical peripherals

The valves are actuated differently depending on whether a multi-pin terminal or fieldbus terminal is used.

The VTSA/VTSA-F with CPX interface is based on the internal bus system of the CPX terminal and uses this communication system for all solenoid coils and a range of electrical input and output functions.

Parallel linking enables the following:

- Transmission of switching information
- Compact design
- Position-based diagnostics
- Separate voltage supply for valves
- Flexible conversion without address shifting
- Transmission of status, parameter and diagnostic data

VTSA with electrical peripherals CPX

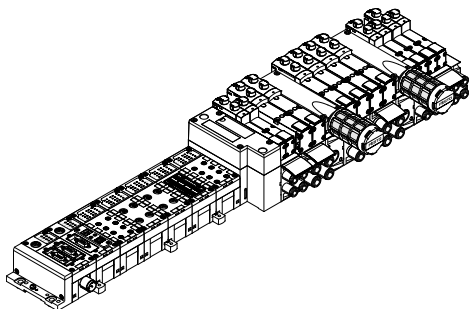

Modularity with electrical peripherals CPX

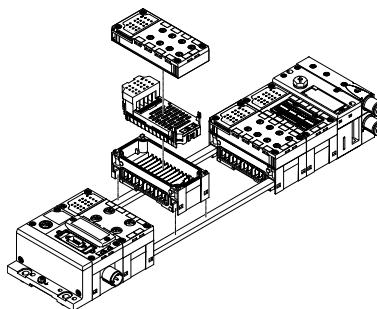

Technical data online → www.festo.com/catalogue/vtisa

 Configurable product

This product and all its product options can be ordered online via the configurator:

→ www.festo.com/catalogue/...

Enter the part number or the type.

Part no.	Type	Electric actuation	Connecting thread
Valve terminal VTSA, conforms to ISO 15407-2 / ISO 5599-2			
539215	VTSA-MP	Multi-pin plug	Metric
539217	VTSA-FB	CPX terminal	Metric
539218	VTSA-FB-NPT	CPX terminal	NPT
Valve terminal VTSA-F, flow-optimised version			
547963	VTSA-F-MP	Multi-pin plug	Metric
547964	VTSA-F-MP-NPT	Multi-pin plug	NPT
547965	VTSA-F-FB	CPX terminal	Metric
547966	VTSA-F-FB-NPT	CPX terminal	NPT

The valve terminals are fully assembled according to your order specifications and are individually tested. This reduces assembly and installation time to a minimum.

Universal valve terminals >

Valve manifolds VTUG-S with individual electrical connection



- Up to 16 valve positions in a fixed grid
- Perfect for fast applications where a particularly high flow at a consistently small size is required
- Multiple different pressure zones on one valve terminal
- Many electrical connection options
- Comprehensive range of accessories
- Flow rate 380 ... 1380 l/min
- Size 10, 14, 18
- Pressure range –0.9 ... 10 bar

Key features

Innovative

- Can be set to internal or external pilot air supply for manifold assemblies with sub-base valves
- Maximum pressure 10 bar
- Design principle:
 - Piston spool with sealing ring (VUVG-LK, VUVG-BK)
 - Piston spool with sealing cartridge (VUVG-L, VUVG-B)

Flexible

- Wide range of valve functions
- Choice of quick plug connectors
- In-line valves
- Semi in-line valves for manifold assembly
- M5 and M7 in-line valves can be combined on one manifold rail
- Valve manifold with pressure zones
- IP40, IP65
- Connection technology via:
 - E-box
 - Pneumatic interface CNOMO, to ISO 15218

Reliable

- Sturdy and durable metal components
 - Valves
 - Manifold rails
- Fast troubleshooting thanks to 360° LED display
- Reliable servicing thanks to valves that can be replaced quickly and easily
- Choice of manual override: non-detenting, covered, non-detenting/detenting or detenting (without accessories)

Valve functions

- 2x3/2-way valve
 - Normally open
 - Normally closed
 - 1x normally closed, 1x normally open
- 5/2-way valve
 - Single solenoid
 - Double solenoid
- 5/3-way valve
 - Mid-position pressurised
 - Mid-position exhausted
 - Mid-position closed

Easy to install

- Secure mounting on wall or H-rail
- Easy mounting, captive screws and seal
- Connection technology easy to change via the E-box
- Inscription label holder for labelling the valves

Valve manifolds VTUG-S with individual electrical connection

Individual valves and valve manifolds

In-line valves as individual valve

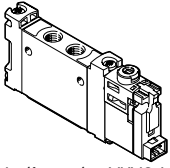
In-line valve VUVG-LK/
VUVG-L

In-line valves are designed to be used without pneumatic links. All pneumatic connections are on the valve and can be equipped with fittings/tubing. The electrical connection is provided by different E-boxes.

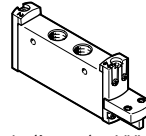
In-line valve VUVG-L to
ISO 15218 (CNOMO)

The in-line valve VTUG-L...-P1 to ISO 15218 is a solenoid valve without electrical pilot control. The basic valve with the pneumatic CNOMO interface to ISO 15218 can be equipped with type C connection (DIN EN 175301-803) or M12 connection (IEC 61076-2-101).

Semi in-line valves for manifold assembly

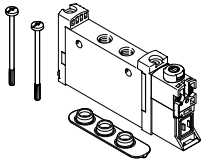
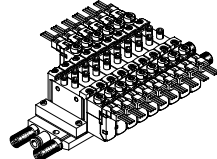
Semi in-line valve
VUVG-SValve manifold VTUG made up of
semi in-line valves VUVG-S

The supply ports (1, 3 and 5) for semi in-line valves are connected to the valve by common pneumatic links (e.g. sub-base). The working ports (2, 4) are on the valve.

The electrical connection is established via variable E-boxes.

Sub-base valves for manifold assembly

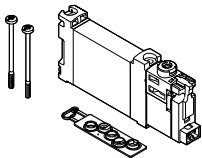
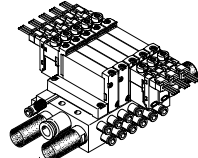
Sub-base valve VU-
VG-BK/VUVG-BValve manifold VTUG made up of
sub-base valves VUVG-BK/
VUVG-B

In the case of sub-base valves, the supply ports (1, 3 and 5) and the working ports (2, 4) are connected to the valve via the pneumatic links (e.g. sub-base).

The electrical connection is established via variable E-boxes.

Basic valves VUVG

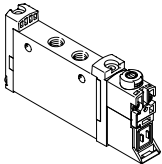

- Size 10, 14 and 18 mm
- In-line valves and semi in-line valves
- Sub-base valves
- 2x 3/2-way, 5/2-way and 5/3-way valves

E-boxes

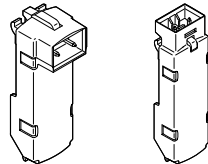

- 5, 12 and 24 V DC
- With or without holding current reduction
- LED

Basic valve and E-box combinations

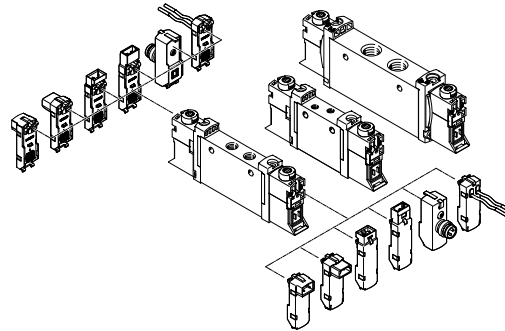

Configurable product

This product and all its product options can be ordered online via the configurator:

→ www.festo.com/catalogue/...

Enter the part number or the type.

Part no.	Type
572230	VTUG-S

The valve manifold is fully assembled according to your order specification and individually checked. This reduces assembly and installation time to a minimum.

Valve terminals VTUG with multi-pin or fieldbus connection

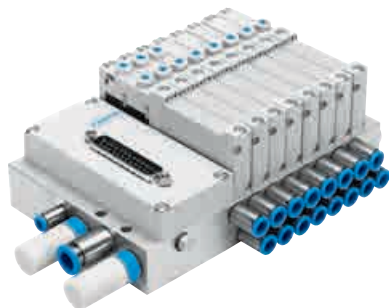

- Up to 24 valve positions in a fixed grid
- Vacuum and pressure on one valve terminal
- Multiple different pressure zones on one valve terminal
- Flexible control cabinet installation
- Flow rate 330 ... 1200 l/min
- Size 10, 14, 18
- Pressure range -0.9 ... 10 bar

Key features

Innovative

- Festo-specific I-Port interface for bus nodes (CTEU)
- IO-Link® mode for direct connection to a higher-level IO-Link® master
- Festo-specific I-Port interface with interlock
- Variable multi-pin plug connection using Sub-D or ribbon cable
- Reversible piston spool valves, up to 24 valve positions
- Reduced power consumption
- Excellent price/performance ratio

Flexible

- Choice of quick plug connectors
- Multiple pressure zones possible
- Sub-D variant and fieldbus interface with protection to IP67
- Internal or external pilot air with the same manifold rail possible through the use of blanking plugs
- Sub-base valves with working ports underneath for installation in control cabinets

Reliable

- Sturdy and durable metal components
 - Valves
 - Manifold rails
- Fast troubleshooting thanks to LED display
- Manual override: choice of non-detenting, detenting or covered

Easy to install

- Easy mounting thanks to captive screws and seal
- Connection technology easy to change
- Inscription label holder for labelling

Valve functions

- 3/2-way valve
 - Single solenoid
 - Normally open
 - Normally closed
- 2x 3/2-way valve
 - Single solenoid
 - Normally open
 - Normally closed
 - 1x normally closed, 1x normally open
 - Mechanical spring
 - Pneumatic spring
- 5/2-way valve
 - Single solenoid
 - Pneumatic/mechanical spring
 - Mechanical spring
 - Pneumatic spring
 - Double solenoid valve
- 5/3-way valve
 - Mid-position pressurised
 - Mid-position exhausted
 - Mid-position closed
- Reversible piston spool valves, up to 24 valve positions

Valve terminals VTUG with multi-pin or fieldbus connection

Electrical connection

Multi-pin plug connection

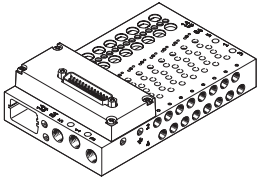

The signals are transmitted from the controller to the valve terminal via a pre-assembled or self-assembled multi-wire cable to the multi-pin plug connection.

This substantially reduces installation time compared to individually connected valves. The valve terminal can be equipped with max. 48 solenoid coils.

Versions:

- Sub-D connection
- Ribbon cable

I-Port interface

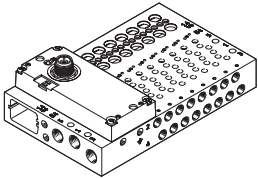

Festo-specific interface as a basis for bus nodes (CTEU) or in IO-Link® mode for direct connection to a higher-order IO-Link® master.

Communication and power supply take place via a common M12 interface.

Connection options:

- As I-Port interface for bus nodes (CTEU)
- In IO-Link® mode for direct connection to an IO-Link® master

I-Port interface with interlock

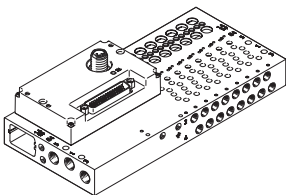

The interlock function enables the first 16 solenoid coils to be individually supplied externally.

The external supply guarantees the safety-related enabling of these valves.

Valves with individual electrical actuation

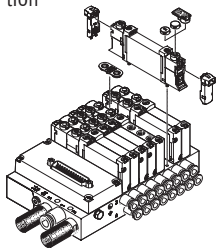

The VTUG variant with multi-pin plug connection and fieldbus interface offers the additional option of individual electrical actuation of the valves.

 Configurable product

This product and all its product options can be ordered online via the configurator:

→ www.festo.com/catalogue/...

Enter the part number or the type.

Part no.	Type
573606	VTUG

The valve terminal is fully assembled according to your order specifications and individually tested. This reduces assembly and installation time to a minimum.

Universal valve terminals >

Valve manifolds VTUS



- Robust valves with long service life VUUS → 169
- Individual electrical connection
- Pilot air supply in the manifold rail
- Comprehensive range of accessories
- Flow rate 600 ... 2300 l/min
- Sizes 20, 25, 30
- Pressure range -0.9 ... 10 bar

Key features

Innovative

- A reliable, sturdy valve with a long service life
- Flow rate up to 2300 l/min
- Wide range of valve functions

Versatile

- Operating voltage can be easily altered by changing the solenoid coil
- In-line valves can be used as individual valves or manifold valves
- Variable pressure zones
- Wide range of mounting options

Reliable

- Ergonomic and safe operation
- Durable thanks to tried-and-tested piston spools
- Reliable servicing thanks to valves that can be replaced quickly and easily

Easy to mount

- Pre-assembled units on rails
- Individual valves assembled ready for installation
- Common supply manifolds for mounting on one or both sides
- Secure mounting on wall or H-rail

Valve functions

- Internal/external pilot air supply
- Reset via pneumatic/mechanical spring
- Direction of flow can be reversed in the case of external pilot air supply

Valve functions

- 3/2-way valve, normally closed, single solenoid
 - Internal/external pilot air supply
 - Reset via pneumatic/mechanical spring
 - Direction of flow can be reversed in the case of external pilot air supply
- 5/2-way valve, single solenoid
 - Internal/external pilot air supply
 - Reset via pneumatic/mechanical spring
 - Direction of flow can be reversed in the case of external pilot air supply
- 5/2-way valve, double solenoid
 - Internal/external pilot air supply
 - Direction of flow can be reversed in the case of external pilot air supply
- 5/3-way valve, mid-position exhausted, pressurised or closed
 - Internal/external pilot air supply
 - Reset via mechanical spring
 - Direction of flow can be reversed in the case of external pilot air supply

Versions

- A maximum of 16 valve positions can be configured in the standard version
- A maximum of 12 valve positions can be configured in the compact version
- Valve positions 2 ... 10 can be configured in increments of 1, valve positions 10 ... 16 in increments of 2
- Manifold block with a maximum of 10 valve positions
- Extension module with 2 valve positions
- Common supply manifold with a maximum of 10 valve positions
- Creation of pressure zones (maximum 9 pressure zones in the case of a valve manifold with 16 valve positions)

Solenoid valves VUUS

In-line valves are designed to be used without pneumatic links. All pneumatic connections are on the valve and can be equipped with fittings/tubing.

In-line valve VUUS-LK as individual valve (piston spool valve)

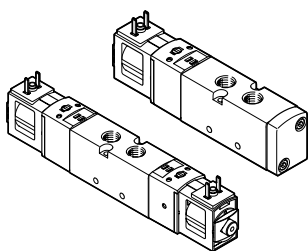

In-line valve VUUS-LT as individual valve (poppet seat valve)

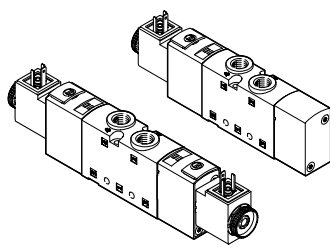

In-line valve VUUS-L as individual valve (piston spool valve)

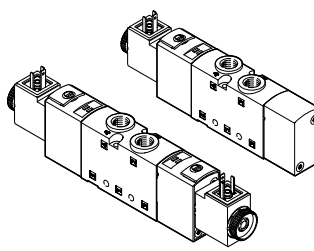

Valve manifold VTUS

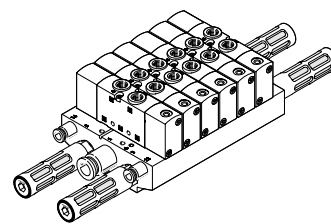

Connection blocks

Standard manifold block
For 3/2-way valves

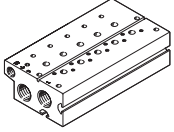

- Connection Size 20: G3/8
Size 25: G1/2
Size 30: G3/4
- For valves with external pilot air supply
- Maximum 10 valve positions

For 5/2-way and 5/3-way valves

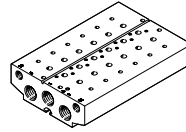

- Connection Size 20: G3/8
Size 25: G1/2
Size 30: G3/4
- For valves with external pilot air supply
- Maximum 10 valve positions

Manifold block extension module, for standard manifold block
For 3/2-way valves

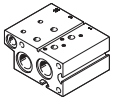

- Connection Size 20: G3/8
Size 25: G1/2
Size 30: G3/4
- Maximum two valve positions

For 5/2-way and 5/3-way valves

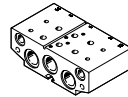

- Connection Size 20: G3/8
Size 25: G1/2
Size 30: G3/4
- Maximum two valve positions

Compact manifold block
For 3/2-way valves

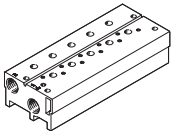

- Connection Size 20: G1/4
Size 25: G3/8
Size 30: G1/2
- Maximum 10 valve positions

For 5/2-way and 5/3-way valves

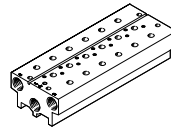

- Connection Size 20: G1/4
Size 25: G3/8
Size 30: G1/2
- Maximum 10 valve positions

Common supply manifold
Mounting on both sides

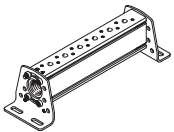

- Connection Size 20: G3/8
Size 25: G1/2
Size 30: G3/4
- Maximum 10 valve positions

Mounting on one side

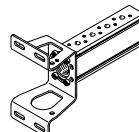

- Connection Size 20: G3/8
Size 25: G1/2
Size 30: G3/4
- Maximum 4 valve positions

Cover plate for vacant position

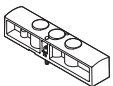

For covering vacant valve positions

Supply plate

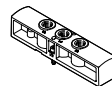

For additional air supply and exhaust via a valve position

Separator for pressure zones



For creating pressure zones (maximum 9 pressure zones permitted)

Configurable product

This product and all its product options can be ordered online via the configurator:

→ www.festo.com/catalogue/...

Enter the part number or the type.

Part no.	Type	Size	Standard nominal flow rate
577304	VTUS-20	20	600 ... 700 l/min
8022016	VTUS-25	25	1000 ... 1300 l/min
8022019	VTUS-30	30	1600 ... 2300 l/min

The valve manifold is fully assembled according to your order specifications and individually tested. This reduces assembly and installation time to a minimum.

Universal valve terminals >

Valve terminals MPA-S with CPX terminal

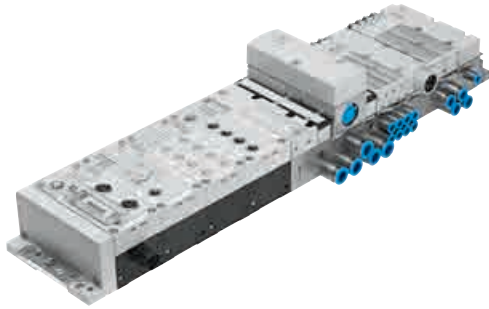

- Actuated via fieldbus or control block
- Max. 64 valve positions/max. 128 solenoid coils
- Digital inputs/outputs
- Analogue inputs/outputs
- Parameterisation of inputs and outputs
- Integrated convenient diagnostic system
- Proportional technology
- Integrated, high-level diagnostics thanks to serial linkage
- Up to 8 voltage zones
- Flow rate 360 ... 700 l/min
- Width 10 mm, 20 mm
- Pressure range 0.9 ... 10 bar

Key features

Innovative

- Compact high-performance valves in sturdy metal housing
- MPA1 Flow rates of up to 360 l/min
- MPA2 Flow rates of up to 700 l/min
- Dream team: fieldbus valve terminal suitable for electrical peripherals CPX. This means:
 - Forward-looking internal communication system for actuating the valves and CPX modules
 - Diagnostics down to the individual valve
 - Valves can be actuated with or without (standard) separate electrical circuits

Versatile

- Modular system offering a range of configuration options
- Expandable with up to 128 solenoid coils
- Conversions and extensions possible at a later date
- Further sub-bases can be expanded using just three screws, sturdy separating seals on metal separator plates
- Integration of innovative function modules possible
- Proportional pressure regulators
- Pressure sensor
- Supply plates enable a flexible air supply and variable pressure zones
- Wide range of pressures –0.9 ... 10 bar
- Wide range of valve functions

Reliable

- Fast troubleshooting thanks to LEDs on the valves and diagnostics via fieldbus
- High operating voltage tolerance $\pm 25\%$
- Easy to service thanks to replaceable valves and electronic modules
- Manual override either non-detenting, detenting or protected against unauthorised activation (covered)
- Durable thanks to tried-and-tested piston spool valves
- Large and durable labelling system, suitable for barcodes

Easy to mount

- Ready-to-install and tested unit
- Reduced selection, ordering, installation and commissioning costs
- Secure mounting on wall or H-rail

Electrical connection options

Fieldbus connection via the CPX system

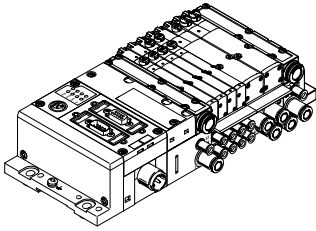

An integrated fieldbus node manages the communications connection with a higher-order PLC. This enables a space-saving pneumatic and electronic solution.

Valve terminals with fieldbus interfaces can be configured with up to 16 sub-bases. In conjunction with MPA1 and 8 solenoid coils per sub-base, up to 128 solenoid coils can thus be actuated. An MPA2 with 4 solenoid coils per sub-base can actuate 64 solenoid coils.

Versions:

PROFIBUS-DP, INTERBUS®, DeviceNet®, CANopen, CC-LINK®, EtherNet/IP, EtherCAT, Modbus®/TCP, PROFINET, POWERLINK, Sercos III, Front End Controller Remote, Front End Controller Remote I/O, CPX terminal

Control block connection via the CPX system

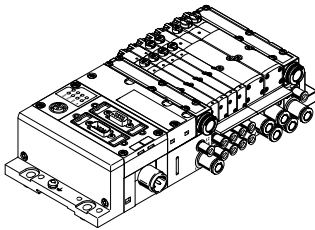

Controllers integrated in the Festo valve terminals enable the construction of stand-alone control units to IP65, without control cabinets.

In the slave operating mode, these valve terminals can be used for intelligent preprocessing and are therefore ideal modules for designs using decentralised intelligence.

In the master operating mode, terminal groups can be designed with many options and functions that can autonomously control a medium-sized machine/system.



Configurable product

This product and all its product options can be ordered online via the configurator:

→ www.festo.com/catalogue/...

Enter the part number or the type.

Part no.	Type	Electrical actuation
530411	MPA-FB-VI	Fieldbus

The valve terminals are fully assembled according to your order specifications and are individually tested. This reduces assembly and installation time to a minimum.

Electrical peripherals >

Automation system CPX-AP-I

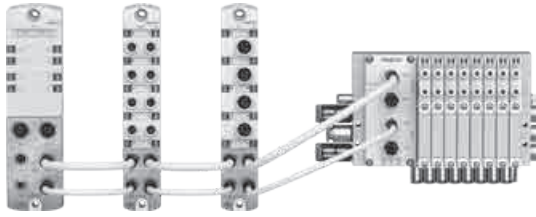

- Decentralised remote I/O system
- Ultra-lightweight and compact
- IO-Link® master and IO-Link® device tool
- Short bus cycle times up to 250 µs
- 2 kByte of I/O process data
- Parallel data processing of real-time and non-real-time data
- Theoretically up to 500 modules in line, star and tree topology
- Cable lengths up to 50 m between stations
- Best price/performance ratio by combining valve terminals and decentralised I/Os

Ordering

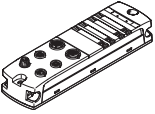
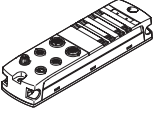
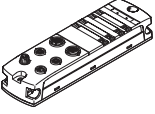
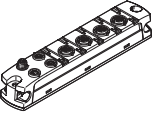
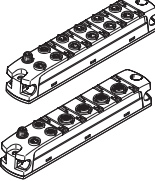
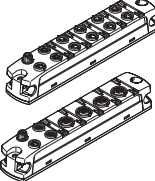
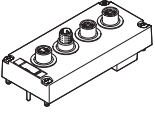
Description			Type	Part no.	
Bus interface					
	PROFINET Interface	<ul style="list-style-type: none"> • Actuation via PROFINET • Two PROFINET connections • Two connections for system communication • Two connections for power supply and transmission 	CPX-AP-I-PN-M12	8086607	
	EtherCAT Interface	<ul style="list-style-type: none"> • Actuation via EtherCAT • Two EtherCAT connections • Two connections for system communication • Two connections for power supply and transmission 	CPX-AP-I-EC-M12	8086609	
	EtherNet/IP Interface	<ul style="list-style-type: none"> • Actuation via EtherNet/IP • Two Ethernet connections • Two connections for system communication • Two connections for power supply and transmission 	CPX-AP-I-EP-M12	8086610	
IO-Link® master					
	IO-Link Master	<ul style="list-style-type: none"> • 4 IO-Link® connections • LED indicator • Master V 1.1 	<ul style="list-style-type: none"> • Electrical connection, IO-Link® 4x sockets M12x1, 5-pin 	CPX-AP-I-4IOL-M12	8086604
Input module					
	Digital input module	<ul style="list-style-type: none"> • 8 inputs • LED indicator • PNP (positive switching) • Characteristic curve of inputs to IEC 61131-2, type 3 	<ul style="list-style-type: none"> • Electrical connection input 8x socket, 3-pin, M8x1 	CPX-AP-I-8DI-M8-3P	8086600
			<ul style="list-style-type: none"> • Electrical connection input 4x socket, 5-pin, M12x1 	CPX-AP-I-8DI-M12-5P	8086602
Digital input/output module					
	Digital input/output module	<ul style="list-style-type: none"> • 4 inputs, 4 outputs • LED indicator • PNP (positive switching) • Characteristic curve of inputs to IEC 61131-2, type 3 • Characteristic curve of outputs to IEC 61131-2, type 0.5 	<ul style="list-style-type: none"> • Electrical connection input 4x socket, 3-pin, M8x1 • Electrical connection output 4x socket, 3-pin, M8x1 	CPX-AP-I-4DI4DO-M8-3P	8086601
			<ul style="list-style-type: none"> • Electrical connection input 2x socket, 5-pin, M12x1 • Electrical connection output 2x socket, 5-pin, M12x1 	CPX-AP-I-4DI4DO-M12-5P	8086603
Electrical interface for valve terminal VTUG					
	AP-COM	<ul style="list-style-type: none"> • LED indicator • Separate load voltage supply for the connected valves, can be shut down separately • Short-circuit disconnection 	<ul style="list-style-type: none"> • Max. 12 valve positions • Max. 24 solenoid coils 	VAEM-L1-S-12-AP	8081922
			<ul style="list-style-type: none"> • Max. 24 valve positions • Max. 48 solenoid coils 	VAEM-L1-S-24-AP	8081923

Accessories

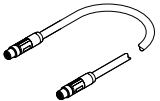
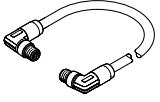
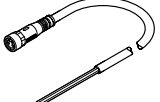
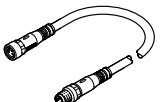
Connecting cables		Electrical connection 1	Electrical connection 2	Cable length	Type	Part no.
	For communication interface	Straight plug, M8x1, 4-pin, D-coded	Straight plug, M8x1, 4-pin, D-coded	0.3 m	NEBC-D8G4-ES-0.3-N-S-D8G4-ET	8082902
				5 m	NEBC-D8G4-ES-5-N-S-D8G4-ET	8065129
		Angled plug, M8x1, 4-pin, D-coded	Angled plug, M8x1, 4-pin, D-coded	0.5 m	NEBC-D8W4-ES-0.5-N-S-D8W4-ET	8065124
				5 m	NEBC-D8W4-ES-5-N-S-D8W4-ET	8065130
	For power supply	Straight socket, M8 x 1, 4-pin, A-coded	Open cable end, 4-wire	5 m	NEBL-M8G4-E-5-N-LE4	8065110
				15 m	NEBL-M8G4-E-15-N-LE4	8065121
	For voltage forwarding	Straight socket, M8 x 1, 4-pin, A-coded	Straight plug, M8 x 1, 4-pin, A-coded	0.3 m	NEBL-M8G4-E-0.3-N-M8G4	8082904
				5 m	NEBL-M8G4-E-5-N-M8G4	8065108

08

Sensors



Highlights



Proximity switches, for T-slot

SMT-8M

- + Short design
- + Variants suitable for use with energy chains and robots

→ 223



Pressure sensors

SPAN

- + Pressure and vacuum
- + 13 pressure measuring ranges
- + All standard pressure units



→ 231

Contents

Product overview	218
Proximity switches SMT-8M, for T-slot	223
Proximity switches SMT-10M, for C-slot	225
Proximity switches SIEN, inductive	227
Pressure sensors SDE5	229
Pressure sensors SPAN	231
Pressure sensors SPAE	234
Flow sensors SFAH	235
Opto-electronic sensors SOOD/SOOE	237



Product overview

Software-Tools

Configurator		<p>Design a product with numerous features reliably and quickly with the help of the configurator.</p> <p>Select all the required product features step-by-step. The use of logic checks ensures that only correct configurations are available for selection.</p> <p>A dynamic graphic generated on the basis of the configuration provides a visual aid for selecting the correct product features.</p> <p>The configurator is part of the electronic catalogue and is not available as a separate software program.</p>
Festo Design Tool 3D		<p>The Festo Design Tool 3D is a 3D product configurator for generating specific CAD product combinations from Festo.</p> <p>The configurator makes your search for the right accessory easier, more reliable and faster.</p> <p>You can then order the module that has been created as a single order item, either completely pre-assembled or as individual parts in a single box.</p> <p>This considerably reduces your bill of materials, and downstream processes such as product ordering, order picking and assembly are significantly simplified.</p> <p>All ordering options are available in the following countries: AT, BE, CH, CZ, DE, DK, ES, EST, FI, FR, GB, GR, HU, IE, IT, NL, NO, PL, PT, RU, SE, SI, SK, TR, ZA.</p> <p>This tool can be found</p> <ul style="list-style-type: none"> via the address: www.festo.com/fdt-3d-online in the countries listed above.



Proximity switches >

Proximity switches, for T-slot

	 <p>Proximity switches SMT-8M-A</p>	 <p>Proximity switches SME-8, SME-8M</p>
Electrical connection		Cable, cable with plug, plug, M8x1, 3-pin, 2-wire, 3-wire
Electrical connection 1, connection type	Cable, cable with plug	Cable, cable with plug
Electrical connection 1, connection technology	M8x1 A-coded to EN 61076-2-104, M12x1 A-coded to EN 61076-2-101, open end	M8x1 A-coded to EN 61076-2-104, M12x1 A-coded to EN 61076-2-101, open end
Electrical connection 1, occupied pins/wires	2, 3, 4	2, 3
Operating voltage range DC	5 ... 30 V	0 ... 230 V
Switching element function	N/C, N/C or N/O, switchable, N/O	N/C, N/O
Switching output	NPN, PNP, PNP/NPN switchable, contactless, 2-wire	Contacting, bipolar, without LED function
Description	<ul style="list-style-type: none"> Measuring principle: magneto-resistive Short design Variants to EU Explosion Protection Directive (ATEX) Insertable in the slot from above, flush with the cylinder profile LED switching status indication LED operating reserve indication Cable length 0.1 ... 30 m 	<ul style="list-style-type: none"> Measuring principle: magnetic reed SME-8-...-S6: heat-resistant design Variants suitable for use with energy chains and robots Screw-clamped or clamped in the slot, insertable in the slot from above or lengthwise LED switching status indication Cable length 0.3, 2.5, 5, 7.5, 0.2 ... 10 m
→ Page/online	223	sme-8

Proximity switches ›

Proximity switches, for C-slot

	 Proximity switches SME-10, SME-10M	 Proximity switches SMT-10M, SMT-10G
Electrical connection	3-wire, 3-pin, cable, cable with plug, M8x1	2-wire, 3-wire, cable, cable with plug, M8x1 A-coded to EN 61076-2-104, M12x1 A-coded to EN 61076-2-101, open end
Operating voltage range DC	5 ... 30 V	5 ... 30 V
Switching element function	N/O	N/O
Switching output	Contacting, bipolar	NPN, PNP, non-contacting, 2-wire
Description	<ul style="list-style-type: none"> • Measuring principle: magnetic reed • Clamped in the C-slot, insertable in the slot from above or lengthwise • LED switching status indication • Cable length 0.3, 2.5 m 	<ul style="list-style-type: none"> • Measuring principle: magneto-resistive • Clamped in the C-slot, insertable in the slot from above or lengthwise • LED switching status indication • Cable length 0.3, 2.5 m
→ Page/online	sme-10	225

Inductive sensors



	 Inductive sensors SIEN
Size	4 mm, 6.5 mm, M12, M12x1, M18, M18x1, M30, M30x1.5, M5x0.5, M8x1
Switching output	NPN, PNP
Switching element function	N/C, N/O
Electrical connection	Cable, plug, 3-pin, 3-wire, M8x1, M12x1
Operating voltage range DC	10 ... 30 V
Description	<ul style="list-style-type: none"> • With standards-based switching distance • For DC voltage • Round design • Metric thread • Flush or non-flush mounting • LED switching status indication • Design with metal or polyamide housing
→ Page/online	227

Product overview



Position sensors

	 <p>Position sensors SRBS</p>
Design	Round
Sensing range	>270°
Analogue output	50 mA
Electrical connection 1, connection type	Cable with plug
Electrical connection 1, connection technology	M8x1 A-coded to EN 61076-2-104
Electrical connection 1, occupied pins/wires	4
Description	<ul style="list-style-type: none"> Used to detect rotation of the shaft on semi-rotary drives DRVS and DSM The sensor can be quickly mounted without having to manually search for switching points Simple and reliable operation using just one pushbutton directly on the device
→ Page/online	srbs

Pressure and vacuum sensors

	 <p>Pressure sensors SDE5</p>	 <p>Pressure sensors SPAN</p>	 <p>Pressure sensors SPAЕ</p>
Pressure measuring range	-1 ... 10 bar	-1 ... 16 bar	-1 ... 10 bar
Switching element function	N/C, N/O, switchable	N/C or N/O, switchable	N/C, N/O, switchable
Switching output	NPN, PNP	2 x PNP or 2 x NPN switchable, PNP/NPN switchable	PNP/NPN switchable
Pneumatic connection	QS-1/4, QS-4, QS-5/32, QS-6	Male thread 1/8 NPT, male thread G1/8, R1/8, female thread G1/8, M5, for tubing O.D. 4	Flange, cartridge 10, push-in sleeve QS-4, QS-6, QS-3, QS-4
Electrical connection	Cable, plug, round design, to EN 60947-5-2, 3-pin, 3-wire, M8x1	Plug, square design, 4-pin	Cable, open end, 3-wire
Display type		Illuminated LCD	LED display, 2-digit
Description	<ul style="list-style-type: none"> Programmable and configurable pressure switch for simple pressure sensing tasks Threshold/window comparator Switching point adjustment by teach-in function Integrated microprocessor Switching status indication by an LED visible from all sides Certification: c UL us Listed (OL), C-Tick 	<ul style="list-style-type: none"> For monitoring compressed air and non-corrosive gases For network monitoring, regulator monitoring, leak testing, object detection Relative measurement method based on a piezo-resistive measuring cell Serial communication integrated using IO-Link® 1.1 Compact design 30 x 30 mm High-contrast, blue backlit display 	<ul style="list-style-type: none"> Electronic pressure sensor with piezoresistive pressure measuring cell, integrated signal processing, numeric pressure indicator in percent, operating key and a switching output, PNP/NPN switchable Display of minimum and maximum measured value All parameters entered can be transferred to other SPAEs (replicator function) IO-Link® communication interface
→ Page/online	229	231	234

Pressure and vacuum sensors



		
	Pressure sensors SPAU	Pressure switches, vacuum switches PEV, VPEV
Pressure measuring range	-1 ... 16 bar	-1 ... 10 bar
Switching element function	N/C or N/O, switchable	Changeover switch
Switching output	2 x PNP or 2 x NPN switchable, 2xPNP	
Pneumatic connection	Flange, 1/8 NPT, G1/8, M5, M7, QS-4, QS-5/32, QS-6, R1/4, R1/8	G1/4, G1/8, M5
Electrical connection		Plug, screw terminal, round design, square design, to DIN 43650, to EN 60947-5-2, type A, 4-pin, M8x1, M12x1
Display type	Illuminated LCD, LED	
Description	<ul style="list-style-type: none"> • For monitoring compressed air and non-corrosive gases • With or without display • Transfer of the pressure value as switching signal, analogue signal or via IO-Link® to the connected control system • Maximum flexibility thanks to versatile pneumatic adaptation and switchable electrical outputs 	<ul style="list-style-type: none"> • Mechanical pressure and vacuum switch • Adjustable switching point • Mounting: screw-in, via through-holes or via H-rail • Visual scale for pressure adjustment • Certification: CCC, c UL us – Recognized (OL), RCM
→ Page/online	spau	pev

Flow sensors



	
	Flow sensors SFAH
Flow measuring range final value	0.1 ... 200 l/min
Operating medium	Argon, nitrogen, compressed air to ISO 8573-1:2010 [6:4:4]
Operating pressure	-0.9 ... 10 bar
Pneumatic connection	Female thread G1/4, G1/8, for tubing O.D. 4, 6, 8
Switching output	2 x PNP or 2 x NPN switchable
Electrical connection 1, connection type	Plug
Electrical connection 1, connection technology	Connection pattern L1J, M8x1 A-coded to EN 61076-2-104
Description	<ul style="list-style-type: none"> • Process, compressed air, forming gas and pneumatic object monitoring, handling of ultra-small parts, leak test • Compact design 20 x 58 mm • Clear 2-line display • Mounting: H-rail mounting, wall or surface mounting, front panel mounting • Serial communication integrated using IO-Link® 1.1
→ Page/online	235

Product overview

Optical sensors

		
	Retro-reflective sensors, diffuse sensors, light barriers SOOD	Retro-reflective sensors, diffuse sensors, distance sensor, light barriers SOOE
Measurement method	Retro-reflective sensor, through-beam sensor, transmitter, receiver, diffuse sensor with background suppression	Retro-reflective sensor, distance sensor, through-beam sensor, transmitter, receiver, diffuse sensor with background suppression, laser contrast sensor, retro-reflective sensor for transparent objects, diffuse sensor
Working range	0 ... 10000 mm	0 ... 12000000 mm
Setting options		IO-Link®, potentiometer, teach-in
Type of light	Laser, red, LED	Laser, red, LED
Switching output	Push-pull	Push-pull
Description	<ul style="list-style-type: none"> • Easy to operate • Quick to commission • Reliable and stable sensing • Attractive price/performance ratio 	<ul style="list-style-type: none"> • Easy to operate • Quick to commission • Reliable and stable sensing • Attractive price/performance ratio
→ Page/online	237	237

Limit switch attachments

			
	Limit switch attachments SRBC	Limit switch attachments SRBE	Limit switch attachments SRAP
Measured variable			Rotation angle
Operating voltage range AC	0 ... 250 V	0 ... 250 V	
Operating voltage range DC	0 ... 175 V	0 ... 60 V	15 ... 30 V
Electrical connection	Screw terminal, 10-pin	Screw terminal, 10-pin, 14-pin	9-pin, screw terminal, plug-in
Type of mounting	Via mounting bracket, on flange ISO 5211	Via mounting bracket, on flange ISO 5211	
Description	<ul style="list-style-type: none"> • Pre-assembled mounting adapter for ease of installation • The trip cams can be easily set without additional tools • Sturdy, corrosion-resistant design, ideal for use in harsh ambient conditions • Clearly visible 3D position indicator allows rapid sensing of the current position of the quarter turn actuator 	<ul style="list-style-type: none"> • The trip cams can be easily set without additional tools • Sturdy, corrosion-resistant design, ideal for use in harsh ambient conditions • Clearly visible 3D position indicator allows rapid sensing of the current position of the quarter turn actuator 	<ul style="list-style-type: none"> • Based on standard VDI/VDE 3845 (NAMUR) • Analogue • For monitoring the position of quarter turn actuators • Sensors based on 2D Hall technology
→ Page/online	330	srbe	srap

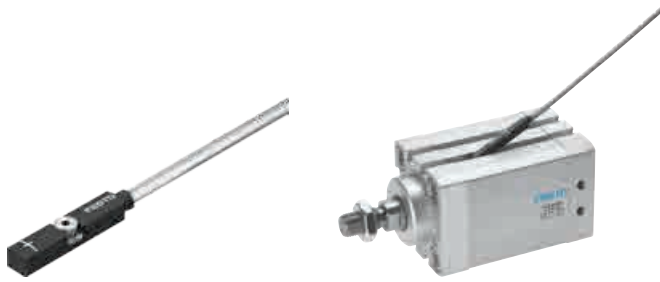

- Switching output via reed contact or non-contacting
- Insertable in the slot from above, does not protrude beyond the cylinder profile
- Variant suitable for use with energy chains and robots
- Cable clip and inscription labels included in the scope of delivery
- With switching status indication
- Selected types in accordance with ATEX directive for potentially explosive atmospheres
→ www.festo.com/ex

Order code – Basic design

001 002 003 004 005 006 007 008 009 010
 SMT 8M A 24V E

Legend: Mandatory entry Optional entry

001	Type
SMT	Proximity switch, magneto-resistive
002	Design
8M	For T-slot, insertable in the slot from above
003	Design
A	Short design
004	Switching output, switching element function
ZS	2-wire PNP N/O
PS	3-wire PNP N/O
NS	3-wire NPN N/O
PO	3-wire PNP N/C
005	Rated operating voltage
24V	24 V DC
006	Cable characteristic
E	Energy chain + robot
007	Cable length

0,3	0.3 m
2,5	2.5 m
5,0	5 m
7,5	7.5 m
008	Cable designation
–	With inscription label holder
009	Electrical connection
OE	Open end
M8D	Cable with plug M8x1, rotatable thread
M12	Cable with plug M12x1, rotatable thread
010	EU certification
–	Without
EX2	II 3GD in accordance with EU Directive 2014/34/EU

Product options

SME	Proximity switch, magnetic reed	DS	N/O, 3-wire
PNS	PNP/NPN switchable	DO	N/C, 3-wire
PSO	PNP, N/C, N/O switchable	M8	Cable with plug M8x1, snap-on flange

N Without inscription label holder

Versions:
Corrosion-resistant, welding field-resistant, heat-resistant

Configurable product

This product and all its product options can be ordered online via the configurator:

→ www.festo.com/catalogue/smt-8m

Proximity switches >

Proximity switches SMT-8M, for T-slot

Ordering – Basic design

001 Measuring principle	004 Switching output	009 Electrical connection			007 Cable length	Type	Part no.
		Cable	Cable with plug, rotatable thread				
			M8x1	M12x1			
004 N/O							
Magneto-resistive	PNP	–	3-pin	–	0.3 m	SMT-8M-A-PS-24V-E-0,3-M8D	574334
		3-wire	–	–	2.5 m	SMT-8M-A-PS-24V-E-2,5-OE	574335
		3-wire	–	–	5 m	SMT-8M-A-PS-24V-E-5,0-OE	574336
		–	–	3-pin	0.3 m	SMT-8M-A-PS-24V-E-0,3-M12	574337
	NPN	3-wire	–	–	2.5 m	SMT-8M-A-NS-24V-E-2,5-OE	574338
		–	3-pin	–	0.3 m	SMT-8M-A-NS-24V-E-0,3-M8D	574339
	Non-contacting	2-wire	–	–	5 m	SMT-8M-A-ZS-24V-E-5,0-OE-Ex2	574341
004 N/C							
Magneto-resistive	PNP	3-wire	–	–	7.5 m	SMT-8M-A-PO-24V-E-7,5-OE	574340

Accessories

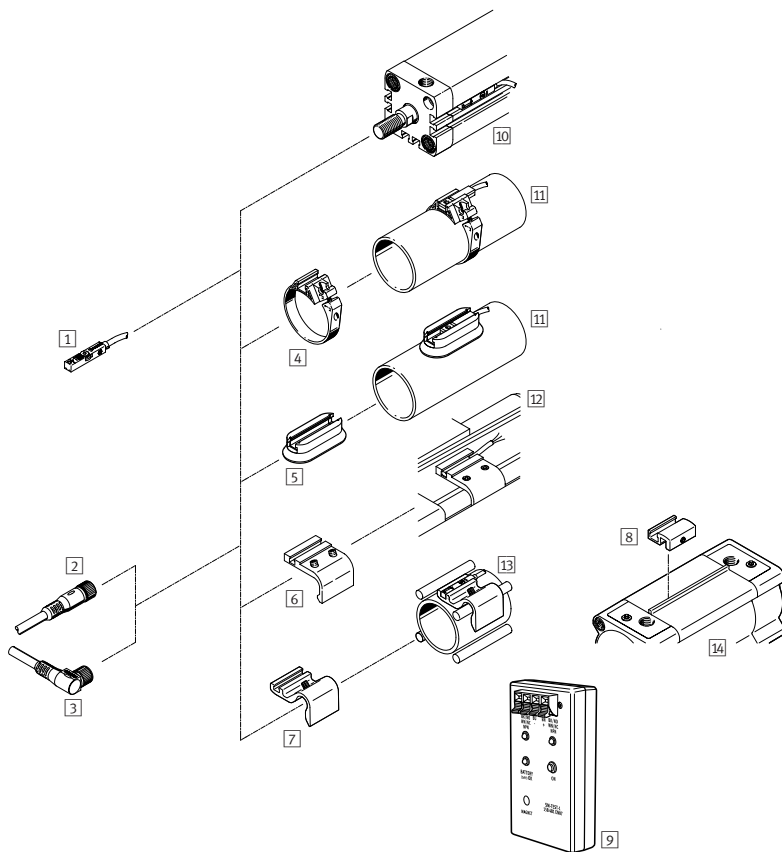

Proximity switches

1 SMT-8M-A-..., with cable → 223

Connecting cables

2 NEBU-M...G... → 279

3 NEBU-M...W... → 279

Mounting kits

4 SMBR → 224

5 CRSMB, corrosion-resistant

→ [smt-8m](#)

6 SMB-8-FENG → [smt-8m](#)

8 SMB-8-C → [smt-8m](#)

Accessories

7 Sensor bracket DASP-M4-

... → [smt-8m](#)

9 Sensor tester

SM-TEST-1 → [smt-8m](#)

Drives

10 Drives with T-slot → 33

11 Round cylinders → 29

12 Standards-based cylinder DSB → 33

13 Drives with tie or mounting rod → 33

14 Standards-based cylinder DSBF → 36

Accessories

4 Mounting kit SMBR		
For Ø	Type	Part no.
8	SMBR-8-8	175091
10	SMBR-8-10	175092
12	SMBR-8-12	175093
16	SMBR-8-16	175094
20	SMBR-8-20	175095
25	SMBR-8-25	175096
32	SMBR-8-32	175097
40	SMBR-8-40	175098
Heat-resistant design		
8 ... 40	SMBR-8-8/100-S6	538937



Proximity switches SMT-10M, for C-slot

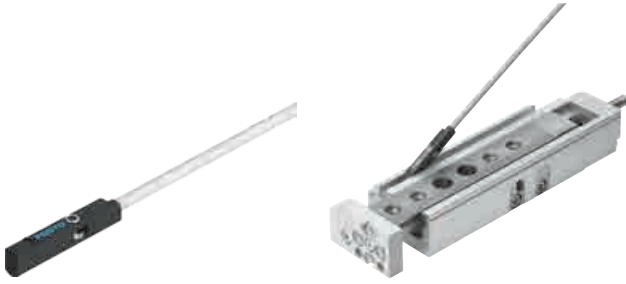

- Switching output PNP, NPN or non-contacting, 2-wire
- Insertable in the slot from above, does not protrude beyond the cylinder profile
- Suitable for use with energy chains and robots
- Cable clip and inscription labels included in the scope of delivery
- With switching status indication

Order code – Basic design

001	002	003	004	005	006	007	008	009	010
SMT	10M		24V	E			L		

Legend: Mandatory entry Optional entry

001	Type
SMT	Proximity switch, magneto-resistive
002	Design
10M	For C-slot, insertable in the slot from above
003	Switching output, switching element function
PS	3-wire PNP N/O
ZS	2-wire PNP N/O
NS	3-wire NPN N/O
004	Rated operating voltage
24V	24 V DC
005	Cable characteristic
E	Suitable for energy chains/robot applications

006	Cable length
0,3	0.3 m
2,5	2.5 m
007	Display
–	LED
008	Connection direction
L	In-line
009	Cable designation
–	With inscription label holder
010	Connection technology
OE	Open end
M8D	Cable with plug M8x1, rotatable thread

Product options

SME	Proximity switch, magnetic reed	Q	Lateral cable outlet	M8	Cable with plug M8x1, snap-on flange	Cable length 0.2 ... 10 m
DS	N/O, 3-wire	N	Without inscription label holder	M12	Cable with plug M12x1, rotatable thread	



Configurable product

This product and all its product options can be ordered online via the configurator:

→ www.festo.com/catalogue/smt-10m

Ordering – Basic design

003 Switching output	008 Cable outlet	Electrical connection		006 Cable length	Type	Part no.
		Cable	Cable with plug, rotatable thread			
003 N/O						
PNP	In-line	3-wire	–	2.5 m	SMT-10M-PS-24V-E-2,5-L-OE	551373
	In-line	–	M8x1, 3-pin	0.3 m	SMT-10M-PS-24V-E-0,3-L-M8D	551375
NPN	In-line	3-wire	–	2.5 m	SMT-10M-NS-24V-E-2,5-L-OE	551377
	In-line	–	M8x1, 3-pin	0.3 m	SMT-10M-NS-24V-E-0,3-L-M8D	551379
Contactless, 2-wire	In-line	2-wire	–	2.5 m	SMT-10M-ZS-24V-E-2,5-L-OE	551382

Proximity switches >

Proximity switches SMT-10M, for C-slot

Accessories

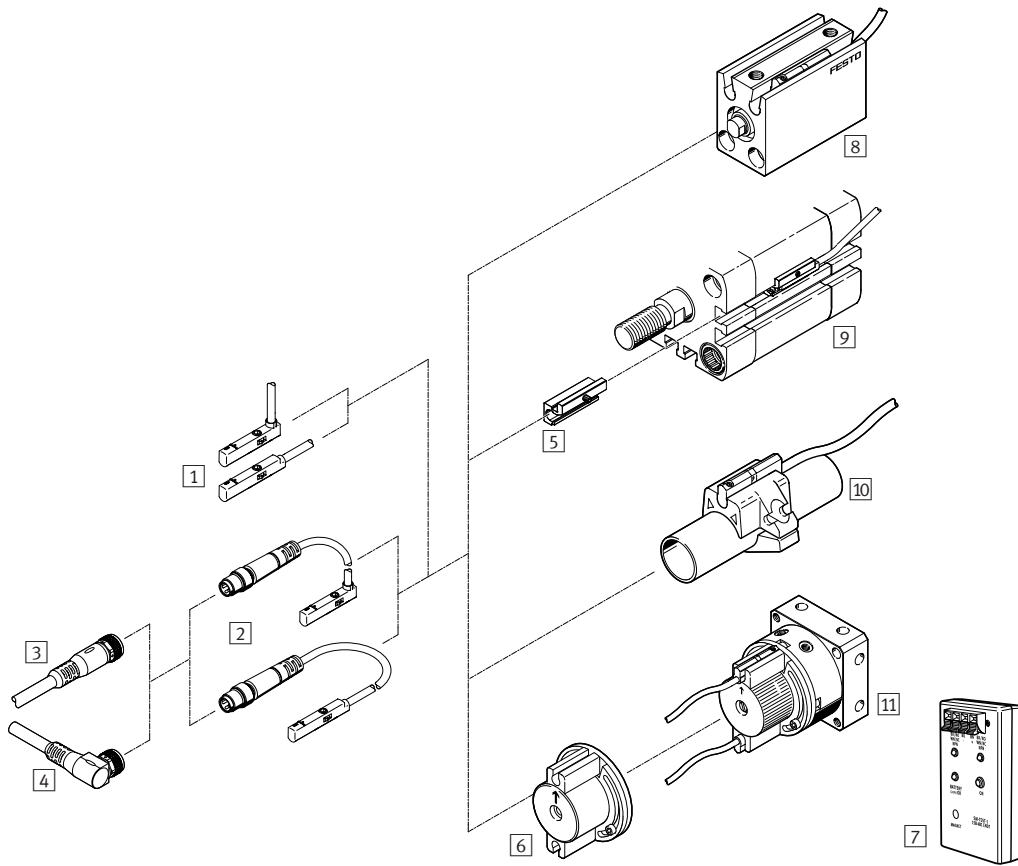

Proximity switches

- 1 SMT-10M-...-OE, with cable → 225
- 2 SMT-10M-...-M..., with cable and plug → 225

Connecting cables

- 3 NEBU-M...G... → 279
- 4 NEBU-M...W... → 279

Mounting kits

- 5 SMBN-10 → [smt-10m](#)
- 6 WSM-...-SME-10 → [smt-10m](#)

Accessories

- 7 Sensor tester SM-TEST-1 → [smt-10m](#)

Drives

- 8 Drives with C-slot → 39
- 9 Drives with T-slot → 33
- 10 Round cylinders → 27
- 11 Swivel module DSM → [dsm](#)



- With standards-based switching distance
- Round design, metric thread, for T-slot
- Flush installation
- With switching status indication
- Design with metal housing

Order code – Basic design

001	002	003	004	005	006	007	008	009
SIE	N			B	N	S		L

Legend: Mandatory entry Optional entry

001	Type
SIE	Proximity switches, inductive
002	Design
N	With standards-based switching distance
003	Design
–	Round
004	Size
M5	Metric thread M5
M8	Metric thread M8
005	Type of mounting
B	Flush

006	Electrical output
N	Switching output NPN
007	Switching element function
S	N/O
008	Electrical connection
K	Cable, 2.5 m, 3-wire
S	Plug, M8x1, 3-pin
009	Display
L	Switching status

Product options

Design

A	With analogue output
D	For DC and AC voltage
F	With reduction factor 1 for all metals, welding field-resistant
H	With increased switching distance
S	Special design

Design

M	Metric thread
Q	Block-shaped
V3	Block-shaped

Size

Ø 4 mm, 6.5 mm; M12, M18x1, M30x1.5

Type of mounting

NB	Non-flush
S	Partially flush

Electrical output

P	Switching output PNP
Z	2-wire output
PU	Analogue output 0 ... 10 V
UI	Analogue output 0 ... 10 V and 4 ... 20 mA

Switching element function

O	N/C
A	Antivalent

Electrical connection

X	Screw terminals
---	-----------------

Display

–	Without display
2L	Switching status and ready status

Version

CR	Stainless steel housing
PA	Polyamide housing
WA	Housing resistant to welding spatter

Configurable product

This product and all its product options can be ordered online via the configurator:

→ www.festo.com/catalogue/sien

Inductive sensors >

Proximity switches SIEN, inductive

Ordering – Basic design

006 Electrical output	004 Size	008 Electrical connection		Cable length	Type	Part no.
		Cable	Plug			
007 N/O						
NPN	Metric thread M5	3-wire	–	2.5 m	SIEN-M5B-NS-K-L	150368
	Metric thread M8	3-wire	–	2.5 m	SIEN-M8B-NS-K-L	150384
	Metric thread M5	–	Plug, M8x1, 3-pin	–	SIEN-M5B-NS-S-L	150369
	Metric thread M8	–	Plug, M8x1, 3-pin	–	SIEN-M8B-NS-S-L	150385

Accessories

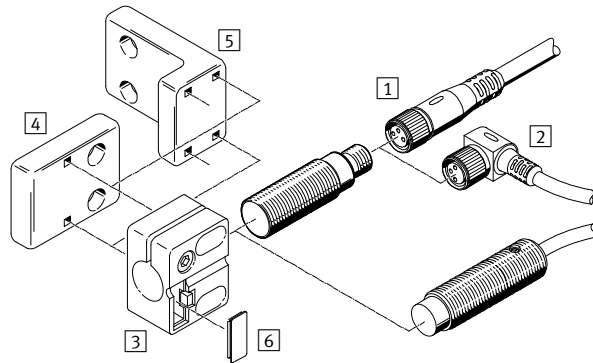

Connecting cables

- 1 NEBU-M...G... → 230
- 2 NEBU-M...W... → 230

Sensor brackets

- 3 SIEZ-...B → [sien](#)
- 4 SIEZ-UV → [sien](#)
- 5 SIEZ-UH → [sien](#)
- 6 Inscription label SIEZ-LB → [sien](#)

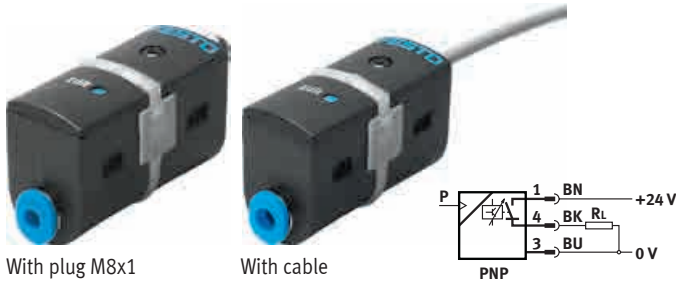

- Programmable and configurable pressure switch for simple pressure sensing tasks
- Relative pressure or differential pressure measurement
- Teach-in function for programming
- Switching status indication by an LED visible from all sides

Order code – Basic design

001 002 003 004 005 006 007
SDE5 - [] - [] - [] - P - []

Legend: [] Mandatory entry [] Optional entry

001	Type
SDE5	Pressure sensor
002	Pressure measuring range
D2	0 ... 2 bar
D10	0 ... 10 bar
V1	0 ... -1 bar
003	Supply port
-	Relative pressure
004	Output function
FP	Freely programmable, selectable N/O, N/C
O	Threshold value with fixed hysteresis, 1 teach-in pressure, N/O
C	Threshold value with fixed hysteresis, 1 teach-in pressure, N/C
O1	Threshold value with fixed hysteresis, 2 teach-in pressures, N/O
O2	Threshold value with variable hysteresis, 2 teach-in pressures, N/O
O3	Window comparator with fixed hysteresis, 2 teach-in pressures, N/O
C3	Window comparator with fixed hysteresis, 2 teach-in pressures, N/C

005	Pneumatic connection
Q4	Push-in connector at both ends, Q4 for tubing O.D. 4 mm
Q6	Push-in connector at both ends, for tubing O.D. 6 mm
Q4E	Push-in connector at one end, for tubing O.D. 4 mm
Q6E	Push-in connector at one end, for tubing O.D. 6 mm
006	Electrical output
P	1 switching output PNP
007	Electrical connection
K	Cable, 2.5m long, 3-wire
M8	Plug M8x1, 3-pin

Product options

Pressure measuring range
D6 0 ... 6 bar

Output function
NF No binary switching function (analogue output)

Pneumatic connection
T532 Push-in connector 5/32"
T14 Push-in connector 1/4"

Electrical accessories

- Connecting cables
- X teach-in point permanently set
- X teach-in point negative
- Y teach-in point permanently set
- Y teach-in point negative

Pressure input
Z Differential pressure

Electrical output
N 1 switching output NPN
V 1 analogue output 0 ... 10 V

Configurable product

This product and all its product options can be ordered online via the configurator:

→ www.festo.com/catalogue/sde5

Ordering – Basic design

004 Output function	002 Pressure measuring range					
	V1: 0 ... -1 bar		D2: 0 ... 2 bar		D10: 0 ... 10 bar	
	Type	Part no.	Type	Part no.	Type	Part no.
Freely programmable (switching/teach-in function, N/O, N/C)	-		-		SDE5-D10-FP-Q6E-P-M8	542897
	SDE5-V1-FP-Q6-P-M8	542887			SDE5-D10-FP-Q6-P-M8	542898
	-				SDE5-D10-FP-Q4E-P-K	542901
					SDE5-D10-FP-Q4E-P-M8	542900
Threshold value with fixed hysteresis, 1 teach-in pressure, N/O	SDE5-V1-O-Q6E-P-M8	527461			SDE5-D10-O-Q6E-P-M8	527467
	-		SDE5-D2-O-Q6E-P-K	542888	SDE5-D10-O-Q6E-P-K	542890
	SDE5-V1-O-Q6-P-M8	527458	-		SDE5-D10-O-Q6-P-M8	527464
	SDE5-V1-O-Q4E-P-M8	527460			SDE5-D10-O-Q4E-P-M8	527466
Threshold value with fixed hysteresis, 1 teach-in pressure, N/C	SDE5-V1-O-Q4-P-M8	527457			SDE5-D10-O-Q4-P-M8	527463
	-		-		SDE5-D10-C-Q6E-P-M8	542894
					SDE5-D10-C-Q4E-P-M8	542889
					SDE5-D10-C-Q6E-P-K	542895
Threshold value with fixed hysteresis, 2 teach-in pressures, N/O	SDE5-V1-O1-Q6-P-M8	542886	-			
Threshold value with variable hysteresis, 2 teach-in pressures, N/O	-		-		SDE5-D10-O2-Q6-P-M8	542892
					SDE5-D10-O2-Q6E-P-M8	542891
Window comparator with fixed hysteresis, 2 teach-in pressures, N/O	-		-		SDE5-D10-O3-Q6E-P-K	542893
Window comparator with fixed hysteresis, 2 teach-in pressures, N/C	-		-		SDE5-D10-C3-Q6E-P-K	542896

Accessories

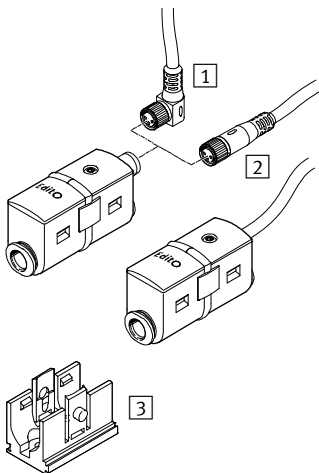

- 1 Connecting cable NEBU-M8W3, angled socket → 230
- 2 Connecting cable NEBU-M8G3, straight socket → 230
- 3 Wall bracket (included in scope of delivery)

1 Connecting cables NEBU-M8W3, M8x1, angled socket			
Cable length	Connection, right	Type	Part no.
Connection, left: angled socket, M8x1, 3-pin			
2.5 m	Cable, open end, 3-wire	NEBU-M8W3-K-2.5-LE3	541338
5 m		NEBU-M8W3-K-5-LE3	541341

2 Connecting cables NEBU-M8G3, M8x1, straight socket			
Cable length	Connection, right	Type	Part no.
Connection, left: straight socket, M8x1, 3-pin			
2.5 m	Cable, open end, 3-wire	NEBU-M8G3-K-2.5-LE3	541333
5 m		NEBU-M8G3-K-5-LE3	541334



- For network monitoring, regulator monitoring, leak test and object detection
- Relative method of measurement, based on a piezoresistive measuring cell
- Serial communication integrated using IO-Link® 1.1
- Compact design
- High-contrast display

Order code – Basic design

001 002 003 004 005 006 007 008 009 010
 SPAN - - R - - - - L1 -

Legend: Mandatory entry Optional entry

001	Type
SPAN	Pressure sensor
002	Product version
-	Standard
003	Pressure measuring range
V1	0 ... -1 bar
B2	-1 ... +1 bar
P10	0 ... 10 bar
B11	-1 ... +10 bar
004	Pressure input
R	Relative pressure
005	Pneumatic connection
G18	G1/8
R18	R1/8
M5	M5
Q4	Push-in connector 4 mm

006	Thread type
-	None
F	Female thread
M	Male thread
007	Electrical output 1
PN	PNP or NPN
PNLK	PNP, NPN or IO-Link®
008	Electrical output 2
PN	PNP or NPN
PNVBA	PNP, NPN
	0 ... 10 V
	1 ... 5 V
	4 ... 20 mA
009	Electrical connection
L1	Plug design L1
010	Certificates
-	None

Product options

Pressure measuring range

P025	0 ... 0.25 bar	P12	0 ... 12 bar
P05	0 ... 0.5 bar	P16	0 ... 16 bar
P1	0 ... 1 bar	V025	0 ... -0.25 bar
P2	0 ... 2 bar	V05	0 ... -0.5 bar
P6	0 ... 6 bar		

Pneumatic connection

N18 1/8 NPT

Product version

B Basic

Certificates

T Test report

Configurable product

This product and all its product options can be ordered online via the configurator:

→ www.festo.com/catalogue/...

Enter the part number or the type.

Part no. Type
8003300 SPAN

Pressure and vacuum sensors >
Pressure sensors SPAN

Ordering – Basic design

Electrical output			005 Pneumatic connection	Type	Part no.
Switching output	Analogue output	Serial interface			
003 Pressure measuring range V1: 0 ... -1 bar					
2 x PNP/NPN Switchable	-	-	G1/8 male, M5 female	SPAN-V1R-G18M-PN-PN-L1	8035546
			R1/8 male, M5 female	SPAN-V1R-R18M-PN-PN-L1	8035549
			Push-in connector 4 mm	SPAN-V1R-Q4-PN-PN-L1	8035554
	0 ... 10 V, 1 ... 5 V 4 ... 20 mA Switchable	IO-Link	G1/8 male, M5 female	SPAN-V1R-G18M-PNLK-PNVBA-L1	8035535
			R1/8 male, M5 female	SPAN-V1R-R18M-PNLK-PNVBA-L1	8035538
			Push-in connector 4 mm	SPAN-V1R-Q4-PNLK-PNVBA-L1	8035543
003 Pressure measuring range B2: -1 ... +1 bar					
2 x PNP/NPN Switchable	-	-	G1/8 male, M5 female	SPAN-B2R-G18M-PN-PN-L1	8035545
			R1/8 male, M5 female	SPAN-B2R-R18M-PN-PN-L1	8035548
			M5 female	SPAN-B2R-M5F-PN-PN-L1	8035551
			Push-in connector 4 mm	SPAN-B2R-Q4-PN-PN-L1	8035553
	0 ... 10 V, 1 ... 5 V 4 ... 20 mA Switchable	IO-Link	G1/8 male, M5 female	SPAN-B2R-G18M-PNLK-PNVBA-L1	8035534
			R1/8 male, M5 female	SPAN-B2R-R18M-PNLK-PNVBA-L1	8035537
003 Pressure measuring range P10: 0 ... 10 bar					
2 x PNP/NPN Switchable	-	-	G1/8 male, M5 female	SPAN-P10R-G18M-PN-PN-L1	8035544
			R1/8 male, M5 female	SPAN-P10R-R18M-PN-PN-L1	8035547
			M5 female	SPAN-P10R-M5F-PN-PN-L1	8035550
			Push-in connector 4 mm	SPAN-P10R-Q4-PN-PN-L1	8035552
	0 ... 10 V, 1 ... 5 V 4 ... 20 mA Switchable	IO-Link	G1/8 male, M5 female	SPAN-P10R-G18M-PNLK-PNVBA-L1	8035533
			R1/8 male, M5 female	SPAN-P10R-R18M-PNLK-PNVBA-L1	8035536
003 Pressure measuring range B11: -1 ... +10 bar					
2 x PNP/NPN Switchable	0 ... 10 V, 1 ... 5 V 4 ... 20 mA Switchable	IO-Link	G1/8 male, M5 female	SPAN-B11R-G18M-PNLK-PNVBA-L1	609149

Accessories

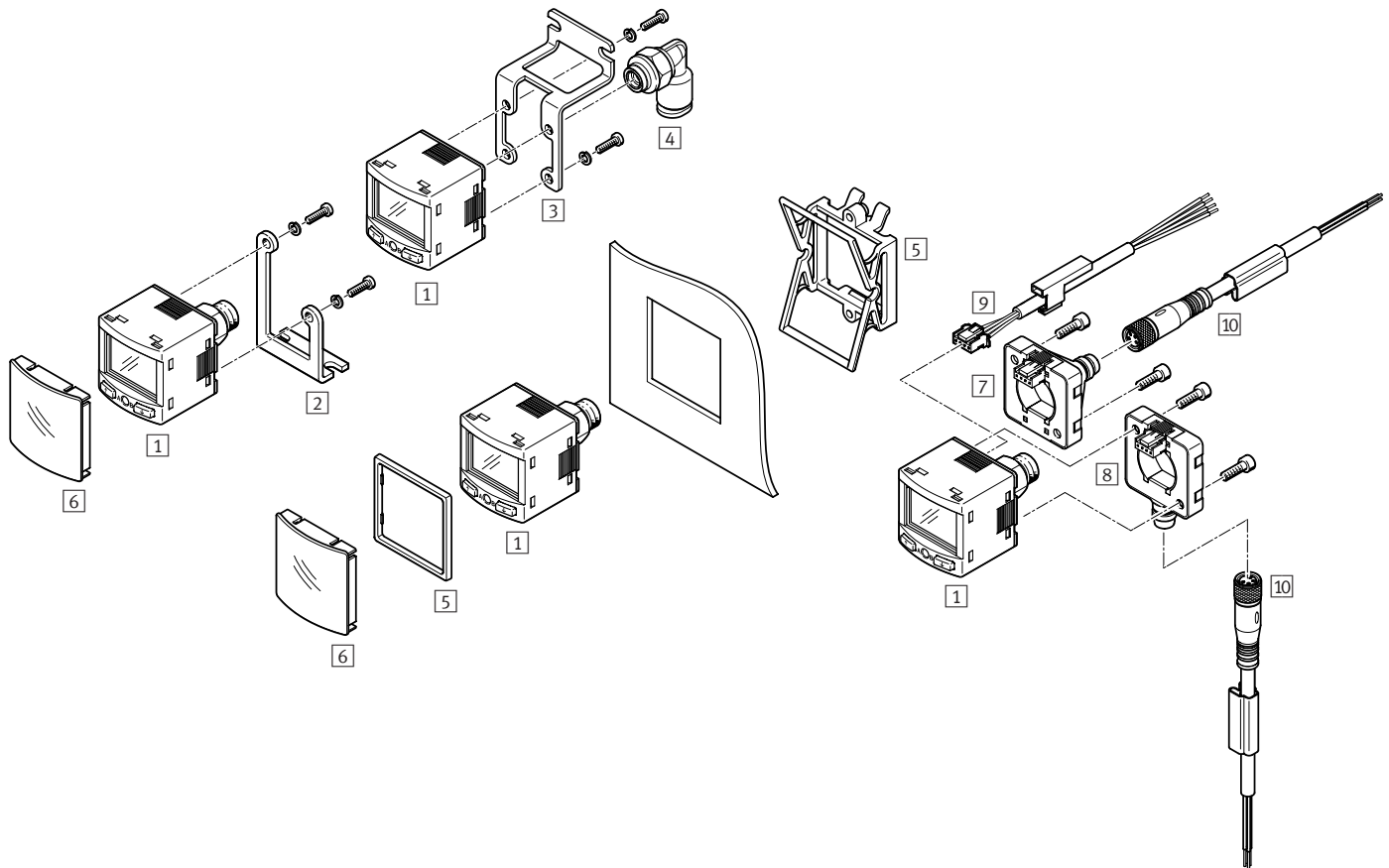

- 1 Pressure sensor SPAN
- 2 Mounting bracket SAMH-PU-A → span
- 3 Wall mounting SAMH-PN-W → span
- 4 Push-in fitting QSML-M5 → 292
- 5 Front panel mounting kit SAMH-PN-F → span
- 6 Safety guard SACC-PN-G → span
- 7 Electrical adapter SASC-P4-A-M8-S (only in combination with NEBU-M8) → span
- 8 Electrical adapter SASC-P4-A-M8-A (only in combination with NEBU-M8) → span
- 9 Connecting cable NEBS-L1G4 → span
- 10 Connecting cable NEBU-M8 → 233

10 Connecting cables NEBU-M8G4, M8x1, straight socket			
Cable length	Connection, right	Type	Part no.
Connection, left: straight socket, M8x1, 4-pin			
2.5 m	Cable, open end, 4-wire	NEBU-M8G4-K-2.5-LE4	541342
5 m		NEBU-M8G4-K-5-LE4	541343

10 Connecting cables NEBU-M8W4, M8x1, angled socket			
Cable length	Connection, right	Type	Part no.
Connection, left: angled socket, M8x1, 4-pin			
2.5 m	Cable, open end, 4-wire	NEBU-M8W4-K-2.5-LE4	541344
5 m		NEBU-M8W4-K-5-LE4	541345

Pressure and vacuum sensors >

Pressure sensors SPAE

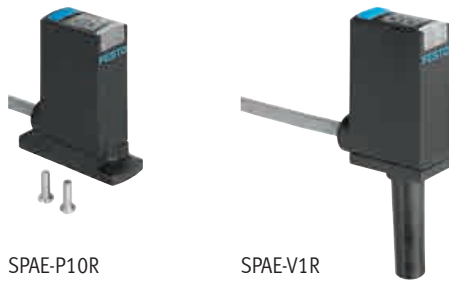

- Pressure sensor
- Vacuum sensor
- Pressure measuring range 0 ... 10 bar, 0 ... -1 bar
- Voltage 18 ... 30 V DC
- Switching output PNP/NPN, switchable
- N/C or N/O, switchable
- Communication interface for IO-Link®

Order code – Basic design

001	002	003	004	005	006
SPAE		R		PNLK	2.5K

Legend: Mandatory entry

001	Type
SPAE	Pressure sensor
002	Pressure measuring range
P10	0 ... 10 bar
V1	0 ... -1 bar
003	Pressure input
R	Relative pressure

004	Pneumatic connection
S4	Push-in sleeve 4 mm
S6	Push-in sleeve 6 mm
Q3	Push-in connector 3 mm
Q4	Push-in connector 4 mm
F	Flange
005	Electrical output
PNLK	Switching output PNP/NPN/IO-Link®
006	Electrical connection
2.5K	Connecting cable 2.5 m, open end

Product options

Pressure measuring range	Pneumatic connection
B2 -1 ... 1 bar	PC10 Cartridge 10 mm

Ordering – Basic design

004 Pneumatic connection	Type	Part no.
002 Pressure measuring range 0 ... -1 bar		
Push-in sleeve 4 mm	SPAE-V1R-S4-PNLK-2.5K	8001440
Push-in sleeve 6 mm	SPAE-V1R-S6-PNLK-2.5K	8001441
Push-in connector 3 mm	SPAE-V1R-Q3-PNLK-2.5K	8001442
Push-in connector 4 mm	SPAE-V1R-Q4-PNLK-2.5K	8001443
Flange	SPAE-V1R-F-PNLK-2.5K	8001444

004 Pneumatic connection	Type	Part no.
002 Pressure measuring range 0 ... 10 bar		
Push-in sleeve 4 mm	SPAE-P10R-S4-PNLK-2.5K	8001445
Push-in sleeve 6 mm	SPAE-P10R-S6-PNLK-2.5K	8001446
Push-in connector 3 mm	SPAE-P10R-Q3-PNLK-2.5K	8001447
Push-in connector 4 mm	SPAE-P10R-Q4-PNLK-2.5K	8001448
Flange	SPAE-P10R-F-PNLK-2.5K	8001449

Accessories

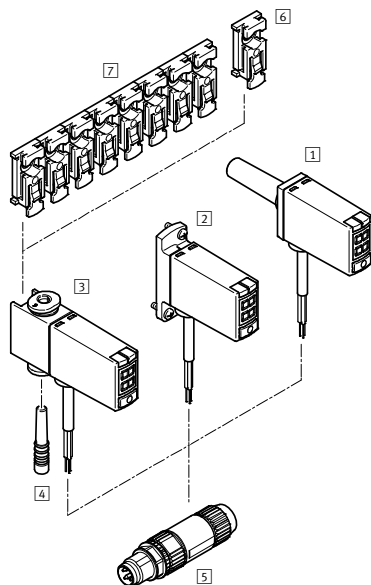

Pressure sensor

- 1 SPAE-...-S...
- 2 SPAE-...-F...
- 3 SPAE-...-Q...
- 4 Blanking plug, for SPAE-...-Q... (included in the scope of delivery)
- 5 Plug NECU-S-M...G3-HX → [spae](#)
- 6 Mounting clip SAMH-PE-MC-1 → [spae](#)
- 7 Mounting clip SAMH-PE-MC-8 → [spae](#)

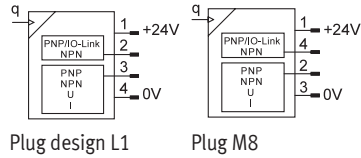

- High measuring dynamics (1:50)
- Measurement method is based on the thermal heat-transfer method
- Clear 2-line display
- Intuitive menu navigation
- L1 and M8 plugs for fast commissioning
- High pressure range –0.9 bar ... 10 bar
- Degree of protection IP40
- Switching output 2 x PNP or 2 x NPN, switchable
- N/C or N/O, switchable

Order code – Basic design

001 002 003 004 005 006 007 008 009 010
SFAH - **U** - **S** - **PNLK** - **PNVBA** -

Legend: Mandatory entry Optional entry

001	Type
SFAH	Flow sensor
002	Flow measuring range
0.1 ¹⁾	Max. 0.1 l/min
0.5	Max. 0.5 l/min
1	max. 1 l/min
5	max. 5 l/min
10	max. 10 l/min
50	max. 50 l/min
100	max. 100 l/min
200	max. 200 l/min
003	Flow input
U	Unidirectional
004	Pneumatic connection
Q4	Push-in connector 4 mm
Q6	Push-in connector 6 mm
Q8	Push-in connector 8 mm
G14	G1/4
G18	G1/8

005	Thread type
-	None
F	Female thread
006	Outlet direction
S	Straight
007	Electrical output 1
PNLK	PNP, NPN or IO-Link®
008	Electrical output 2
PNVBA	PNP, NPN 0 ... 10 V, 1 ... 5 V or 4 ... 20 mA
009	Electrical connection
L1	Plug design L1
M8	Plug connector M8
010	Certificates
-	None

1) For low leakage requirements in the lower measuring range, use G1/4 or G1/8 female thread in combination with pneumatic connection.

Product options

- | | | |
|-----------|--|----------------------|
| B | Bidirectional flow input | Certificates |
| AR | Output direction angled, can be adjusted | T Test report |

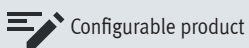

This product and all its product options can be ordered online via the configurator:

→ www.festo.com/catalogue/...

Enter the part number or the type.

Part no.	Type
8035300	SFAH

Flow sensors SFAH

Ordering – Basic design

002 Flow measuring range	004 Pneumatic connection	Type	Part no.	
0.1 l/min	For tubing O.D. 4 mm	SFAH-0.1U-Q4S-PNLK-PNVBA-L1	8058461	
		SFAH-0.1U-Q4S-PNLK-PNVBA-M8	8058462	
0.5 l/min		SFAH-0.5U-Q4S-PNLK-PNVBA-L1	8058463	
		SFAH-0.5U-Q4S-PNLK-PNVBA-M8	8058464	
1 l/min		SFAH-1U-Q4S-PNLK-PNVBA-L1	8058465	
		SFAH-1U-Q4S-PNLK-PNVBA-M8	8058466	
5 l/min		For tubing O.D. 6 mm	SFAH-5U-Q6S-PNLK-PNVBA-L1	8058467
			SFAH-5U-Q6S-PNLK-PNVBA-M8	8058468
10 l/min	SFAH-10U-Q6S-PNLK-PNVBA-L1		8058469	
	SFAH-10U-Q6S-PNLK-PNVBA-M8		8058470	
50 l/min	For tubing O.D. 8 mm		SFAH-50U-Q8S-PNLK-PNVBA-L1	8058471
			SFAH-50U-Q8S-PNLK-PNVBA-M8	8058472
100 l/min	Female thread G1/8	SFAH-50U-G18FS-PNLK-PNVBA-M8	8058473	
	For tubing O.D. 8 mm	SFAH-100U-Q8S-PNLK-PNVBA-L1	8058474	
		SFAH-100U-Q8S-PNLK-PNVBA-M8	8058475	
	Female thread G1/4	SFAH-100U-G14FS-PNLK-PNVBA-M8	8058476	
200 l/min	For tubing O.D. 8 mm	SFAH-200U-Q8S-PNLK-PNVBA-L1	8058477	
		SFAH-200U-Q8S-PNLK-PNVBA-M8	8058478	
	Female thread G1/4	SFAH-200U-G14FS-PNLK-PNVBA-M8	8058479	

Accessories

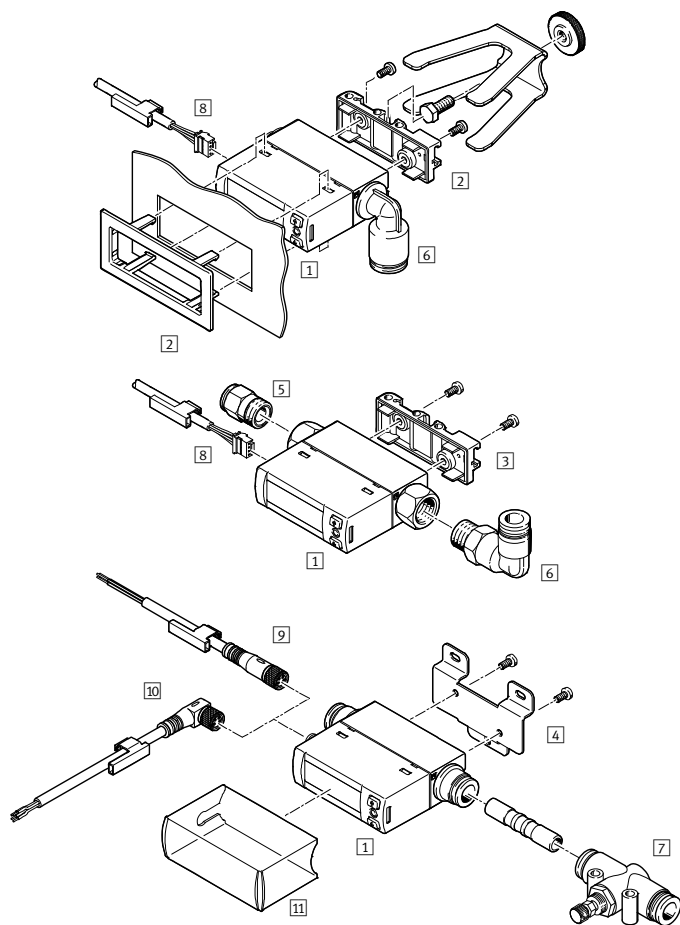

- 1 Flow sensor SFAH
- 2 Front panel mounting kit SAMH-FH-F → sfah
- 3 H-rail mounting SAMH-FH-H → sfah
- 4 Wall mounting SAMH-FH-W → sfah
- 5 Push-in fitting QS → 293
- 6 Push-in fitting QSL → 293
- 7 One-way flow control valve GRO-QS-... → gro
- 8 Connecting cable NEBS-L1G4-... → sfah
- 9 Connecting cable NEBU-M8G4 → 236
- 10 Connecting cable NEBU-M8W4 → 236
- 11 Safety guard SACC-FH-G-S3, only in combination with electrical connection M8 → sfah

9 Connecting cables NEBU-M8G4, M8x1, straight socket			
Cable length	Connection, right	Type	Part no.
Connection, left: straight socket, M8x1, 4-pin			
2.5 m	Cable, open end, 4-wire	NEBU-M8G4-K-2.5-LE4	541342

10 Connecting cables NEBU-M8W4, M8x1, angled socket			
Cable length	Connection, right	Type	Part no.
Connection, left: angled socket, M8x1, 4-pin			
2.5 m	Cable, open end, 4-wire	NEBU-M8W4-K-2.5-LE4	541344



S00D

- Diffuse sensors S00D-BS
 - Retro-reflective sensors S00D-RS
 - Light barriers S00D-TB
- For very tight application environments

Diffuse sensors S00D-BS

- Diffuse sensor with background suppression
- The switching distance is set using optical triangulation
- Switching distance virtually independent of colour and surface
- Can also be used with a shiny or reflective background
- Detection of small differences in distance
- Easy adjustment

Retro-reflective sensors S00D-RS

- Retro-reflective sensors with two lenses
- Particularly economical

Light barriers S00D-TB

- Through-beam sensors
- Transmitter and receiver in different housings
- Most reliable principles in harsh ambient conditions



S00E

- Diffuse sensors S00E-BS, S00E-DS, S00E-KS
 - Distance sensors S00E-MS
 - Retro-reflective sensors S00E-RG, S00E-RS
 - Light barriers S00E-TB
- IO-Link® interface
 - High-precision multi-pixel technology (MPT)

Diffuse sensors S00E-BS

- Diffuse sensor with background suppression
- The switching distance is set using optical triangulation
- Switching distance virtually independent of colour and surface
- Can also be used with a shiny or reflective background
- Detection of small differences in distance
- Easy adjustment

Diffuse sensors S00E-DS

- Cheaper
- Longer switching distance
- More reliable for detecting only slightly reflective objects

Diffuse sensors S00E-KS

- Highly precise, energetic contrast sensor
- Detects small contrast differences within a working range up to 120 mm

Distance sensors S00E-MS

- Sensors evaluate the distance and transfer the value via IO-Link®

Retro-reflective sensors S00E-RG

- Retro-reflective sensors with auto-collimation
- No blind zone
- High precision across the entire sensing range
- Radially symmetrical sensing range
- Good repeatability
- Low hysteresis
- Particularly suitable for transparent objects

Retro-reflective sensors S00E-RS

- Retro-reflective sensors with two lenses
- Particularly economical

Light barriers S00E-TB

- Through-beam sensors
- Transmitter and receiver in different housings
- Most reliable principles in harsh ambient conditions

Optical sensors >

Opto-electronic sensors S00D/S00E

Order code – S00D

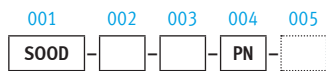

001	Type
S00D	Opto-electronic sensors
002	Sensor function
BS	Diffuse sensor with background suppression
RS	Retro-reflective sensor
TB	Through-beam sensor
003	Type of light
L	Red laser
R	Red LED
004	Electrical output
PN	PNP or NPN (push-pull)
005	Output range
-	Standard
30	30 mm
50	50 mm
80	80 mm

Legend: Mandatory entry Optional entry

Order code – S00E

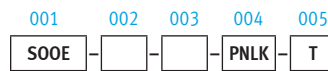

001	Type
S00E	Opto-electronic sensors
002	Sensor function
BS	Diffuse sensor with background suppression
DS	Diffuse sensor
KS	Contrast sensor
MS	Distance sensor
RG	Retro-reflective sensor for transparent objects
RS	Retro-reflective sensor
TB	Through-beam sensor
003	Type of light
L	Red laser
R	Red LED
004	Electrical output
PNLK	PNP or NPN or IO-Link®
005	Setting options
T	Teach-in

Legend: Mandatory entry

Ordering – S00D

003 Type of light	Type	Part no.
002 Diffuse sensor with background suppression		
Red laser	S00D-BS-L-PN-30	8075658
	S00D-BS-L-PN-50	8075659
	S00D-BS-L-PN-80	8075660
Red LED	S00D-BS-R-PN-30	8075653
	S00D-BS-R-PN-50	8075654
	S00D-BS-R-PN-80	8075655
002 Retro-reflective sensor		
Red laser	S00D-RS-L-PN	8075662
Red LED	S00D-RS-R-PN	8075657
002 Through-beam sensor (transmitter and receiver included in the scope of delivery)		
Red laser	S00D-TB-L-PN	8075661
Red LED	S00D-TB-R-PN	8075656

Ordering – S00E

003 Type of light	Type	Part no.
002 Diffuse sensor with background suppression		
Red laser	S00E-BS-L-PNLK-T	8075670
Red LED	S00E-BS-R-PNLK-T	8075664
002 Diffuse sensor		
Red LED	S00E-DS-R-PNLK-T	8075663
002 Contrast sensor		
Red laser	S00E-KS-L-PNLK-T	8075669
002 Distance sensor		
Red laser	S00E-MS-L-PNLK-T	8075673
Red LED	S00E-MS-R-PNLK-T	8075668
002 Retro-reflective sensor for transparent objects		
Red LED	S00E-RG-R-PNLK-T	8075667
002 Retro-reflective sensor		
Red laser	S00E-RS-L-PNLK-T	8075672
Red LED	S00E-RS-R-PNLK-T	8075666
002 Through-beam sensor (transmitter and receiver included in the scope of delivery)		
Red laser	S00E-TB-L-PNLK-T	8075671
Red LED	S00E-TB-R-PNLK-T	8075665

Accessories – SOOD

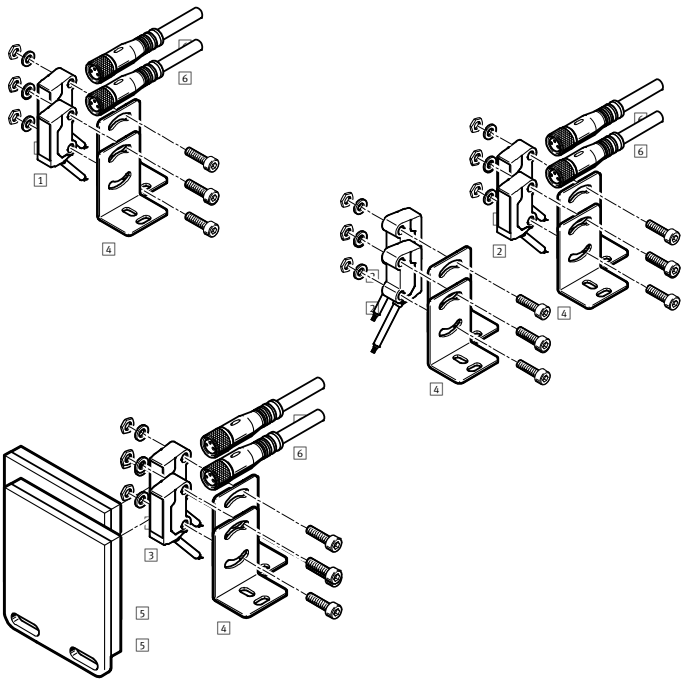

- 1 Diffuse sensor with background suppression, red laser, SOOD-BS-L
- 2 Through-beam sensor SOOD-TB
- 3 Retro-reflective sensor SOOD-RS
- 4 Mounting bracket SAMH-L2-... → sood
- 5 Reflector, reflective foil SARA-R-... → sood
- 6 Connecting cable NEBU-M8 → 239

Accessories – SOOE

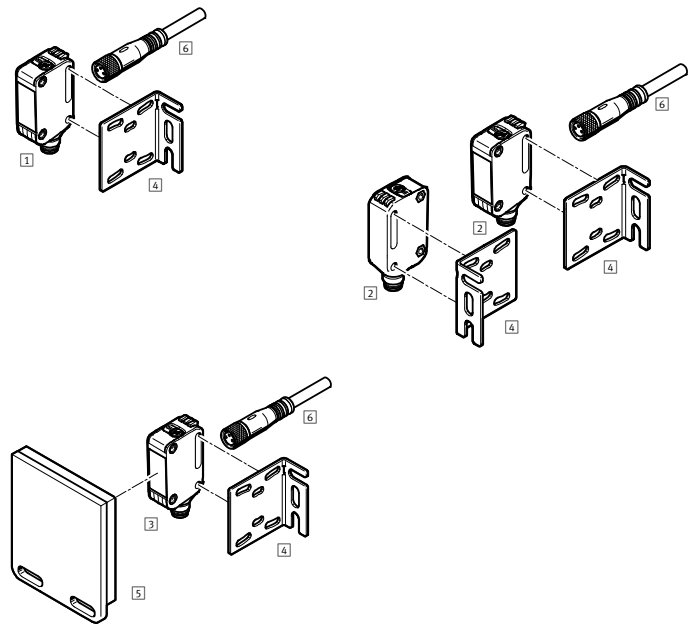

- 1 Retro-reflective sensor SOOE-RS
- 2 Through-beam sensor SOOE-TB
- 3 Retro-reflective sensor with background suppression SOOE-BS
- 4 Mounting bracket SAMH-L3-... → sooe
- 5 Reflector, reflective foil SARA-R-... → sooe
- 6 Connecting cable NEBU-M8 → 239

6 Connecting cables NEBU-M8G3, M8x1, straight socket

Cable length	Connection, right	Type	Part no.
Connection, left: straight socket, M8x1, 3-pin			
2.5 m	Cable, open end, 3-wire	NEBU-M8G3-K-2.5-LE3	541333
5 m		NEBU-M8G3-K-5-LE3	541334

Connecting cable NEBU-M8W3, M8x1, angled socket

Cable length	Connection, right	Type	Part no.
Connection, left: angled socket, M8x1, 3-pin			
2.5 m	Cable, open end, 3-wire	NEBU-M8W3-K-2.5-LE3	541338
5 m		NEBU-M8W3-K-5-LE3	541341

09

Compressed air preparation



Highlights

Contents



Service units, MS series

MSB

- + Combinations of filter regulator, filter, lubricator, on/off valve and soft-start valve
- + Sizes: 4, 6

→ 252



Filter regulators, MS series

MS2-LFR-B

- + Size: 2
- + Flow rate 140 ... 310 l/min
- + Pressure gauge with bar, psi, MPa

→ 256



Pressure regulators, MS series

MS2-LR-B



- + Size: 2
- + Flow rate 170 ... 350 l/min
- + Pressure gauge with bar, psi, MPa

→ 260

Product overview	242
Service units MSB4/MSB6, MS series	252
Service units MSB4/MSB6-FRC, MS series	254
Filter regulators MS2-LFR-B, MS series	256
Filter regulators MS4/MS6/MS12-LFR, MS series	258
Pressure regulators MS2-LR-B, MS series	260
Pressure regulators MS4/MS6/MS12-LR, MS series	262
On/off valves MS4/MS6-EM1, MS4/MS6-EE, MS series	264
Soft-start/quick exhaust valves MS4/MS6-DL, MS6-SV, MS series	266
Branching modules MS4/MS6-FRM, MS series	268
Distributor blocks MS4/MS6-FRM-FRZ, MS series	270
Connecting plate kit MS4/MS6-AG... ..	271



Product overview

Software-Tools

<p>Air consumption</p>		<p>Calculate your system's air consumption quickly and conveniently. Simply enter all the drives and tubing, set the cycle times and working pressure and the air consumption per minute and per day will be calculated for you. It includes a feature for exporting the input table together with the result directly to Excel.</p> <p>This tool can be found</p> <ul style="list-style-type: none"> on our website at www.festo.com/catalogue by clicking on the blue button "Engineering".
<p>Configurator</p>		<p>Design a product with numerous features reliably and quickly with the help of the configurator.</p> <p>Select all the required product features step by step. The use of logic checks ensures that only correct configurations are available for selection.</p> <p>A dynamic graphic generated on the basis of the configuration provides a visual aid for selecting the correct product features.</p> <p>The configurator is part of the electronic catalogue and is not available as a separate software program.</p>



Service units >

MS series

	 Service units MSB4, MSB6, MSB9	 Energy efficiency modules MSE6-E2M
Pneumatic connection 1	G1, G1 1/2, G1 1/4, G1/2, G1/4, G1/8, G3/4, NPT1 1/2-11 1/2, NPT1 1/4-11 1/2, NPT1-11 1/2, NPT1/2-14, NPT3/4-14	G1/2
Standard nominal flow rate	750 ... 18000 l/min	
Flow measuring range final value		5000 l/min
Pressure regulation range	0.5 ... 16 bar	
Operating pressure	0 ... 20 bar	3.5 ... 10 bar
Grade of filtration	0.01 ... 40 µm	
Fieldbus interface		2x socket, M12x1, 4-pin, D-coded, 2x RJ45 push-pull socket, AIDA, 2x SCRJ push-pull socket, AIDA, Sub-D socket, 9-pin
Description	<ul style="list-style-type: none"> Combination of filter regulator, filter, lubricator, on/off valve, soft-start valve Grid dimensions 40, 62, 90 mm (size 4, 6, 9) 	<ul style="list-style-type: none"> Intelligent service unit component for optimising the use of compressed air as an energy medium in industrial automation technology Combination of stop valve, flow sensor, pressure sensor and fieldbus node Identification of machine downtimes and leakages User-controlled shut-off and pressurisation Equipped with measuring, control and diagnostic functions Fieldbus connection (PROFIBUS DP, PROFINET IO, EtherNet/IP or EtherCAT®) via integrated fieldbus nodes enables connection to a higher-level controller Grid dimensions 62 mm (size 6)
→ Page/online	252	mse6



Service units > Classic >

D series, metal

	 Service units with lubricator FRC-K	 Service units without lubricator LFR-K, LFRS-K
Pneumatic connection 1	G1/2, G1/4, G1/8, G3/4, G3/8	G1/2, G1/4, G1/8, G3/4, G3/8
Standard nominal flow rate	530 ... 8200 l/min	575 ... 9400 l/min
Pressure regulation range	0.5 ... 12 bar	0.5 ... 12 bar
Operating pressure	1 ... 16 bar	1 ... 16 bar
Grade of filtration	40 µm	40 µm
Description	<ul style="list-style-type: none"> • Combination of filter regulator, branching module, lubricator, on/off valve, soft-start valve, mounting accessories • Size mini, midi, maxi 	<ul style="list-style-type: none"> • Combination of filter regulator, branching module, on/off valve, soft-start valve, mounting accessories • Size mini, midi, maxi
→ Page/online	frc	lfr

Service units >

D series, polymer

	 Service units with lubricator FRC-K	 Service units without lubricator LFR-DB
Pneumatic connection 1	G1/4	G1/4
Standard nominal flow rate	400 ... 700 l/min	1900 l/min
Pressure regulation range	0.5 ... 7 bar	0.5 ... 7 bar
Operating pressure	1.5 ... 10 bar	1.5 ... 10 bar
Grade of filtration	40 µm	40 µm
Description	<ul style="list-style-type: none"> • Combination of on/off valve, filter regulator, distributor module and lubricator • Size mini 	<ul style="list-style-type: none"> • Combination of on/off valve, filter regulator and distributor module • Size mini
→ Page/online	frc	lfr

Product overview

Filter regulators/lubricators >

MS series



Service units
MSB4-FRC, MSB6-FRC

Pneumatic connection 1	G1/2, G1/4, G1/8, G3/8
Standard nominal flow rate	850 ... 4800 l/min
Pressure regulation range	0.3 ... 12 bar
Operating pressure	0.8 ... 20 bar
Grade of filtration	5 µm, 40 µm
Description	<ul style="list-style-type: none"> • Filter, regulator and lubricator functions in a single unit • High flow rate and highly efficient in removing contaminants • Good regulation characteristics with minimal pressure hysteresis • Grid dimensions 40, 62 mm (size 4, 6)
→ Page/online	254

Filter regulators/lubricators > Classic >

D series, metal



Service units
FRC, FRCS

Pneumatic connection 1	G1, G1/2, G1/4, G1/8, G3/4, G3/8, M5, M7, QS-4, QS-6
Standard nominal flow rate	80 ... 8700 l/min
Pressure regulation range	0.5 ... 12 bar
Operating pressure	1 ... 16 bar
Grade of filtration	5 ... 40 µm
Description	<ul style="list-style-type: none"> • Filter, regulator and lubricator functions in a single unit • Size micro, mini, midi, maxi
→ Page/online	frc

Filter regulators/lubricators >

D series, polymer



Service units
FRC-DB

Pneumatic connection 1	G1/4, G1/8
Standard nominal flow rate	≥400
Pressure regulation range	0.5 ... 7 bar
Operating pressure	1.5 ... 10 bar
Grade of filtration	5 ... 40 µm
Description	<ul style="list-style-type: none"> • Filter, regulator and lubricator functions in a single unit • With manual or semi-automatic condensate drain • Size mini
→ Page/online	frc

Filter regulators >

MS series

 Filter regulators MS2-LFR, MS4-LFR, MS6-LFR, MS9-LFR, MS12-LFR	
Pneumatic connection 1	Internal, G1/2, G1/4, G1/8, G3/8, M5, QS-6
Standard nominal flow rate	140 ... 24000 l/min
Pressure regulation range	0.3 ... 16 bar
Operating pressure	0.8 ... 20 bar
Grade of filtration	5 µm, 40 µm
Description	<ul style="list-style-type: none"> • MS2-LFR, MS4-LFR, MS6-LFR: directly actuated diaphragm regulator, MS9-LFR: piloted or directly actuated filter-diaphragm regulator, MS12-LFR: piloted diaphragm regulator without internal air consumption • Good control characteristics with minimal pressure hysteresis and primary pressure compensation • Good particle and condensate separation • With or without secondary venting • High flow rate • Lockable rotary knob • Return flow option for exhausting from output 2 to input 1 already integrated • Grid dimensions 25, 40, 62, 90, 124 mm (size 2, 4, 6, 9, 12)
→ Page/online	256, 258

Filter regulators > Classic >

D series, metal

 Filter regulators LFR, LFRS	
Pneumatic connection 1	G1, G1/2, G1/4, G1/8, G3/4, G3/8, M5, M7, QS-4, QS-6
Standard nominal flow rate	110 ... 11000 l/min
Pressure regulation range	0.5 ... 12 bar
Operating pressure	1 ... 16 bar
Grade of filtration	5 ... 40 µm
Description	<ul style="list-style-type: none"> • Two pressure gauge connections for different installation options • With manual, semi-automatic or fully automatic condensate drain • Lockable rotary knob • Size micro, mini, midi, maxi
→ Page/online	lfr

Product overview

Filter regulators >

D series, polymer



Filter regulators
LFR-DB

Pneumatic connection 1	G1/4, G1/8
Standard nominal flow rate	≥500
Pressure regulation range	0.5 ... 7 bar
Operating pressure	1.5 ... 10 bar
Grade of filtration	5 ... 40 µm
Description	<ul style="list-style-type: none"> • With manual or semi-automatic condensate drain • Size mini
→ Page/online	lfr

Filter regulators >

Individual devices





Filter regulators
PCR

Pneumatic connection 1	1/4 NPT, 1/2 NPT, G1/2, G1/4, NPT1/2-14, NPT1/4-18
Standard nominal flow rate	1920 ... 4115 l/min
Pressure regulation range	0.5 ... 12 bar
Operating pressure	1 ... 20 bar
Grade of filtration	5 µm, 40 µm
Description	<ul style="list-style-type: none"> • Robust housing for the specific requirements of process automation • Suitable for use outdoors and at temperatures down to -60 °C • Resistant to UV radiation and corrosive environments • With manual condensate drain, rotating • Size: 64
→ Page/online	358



Pressure regulators >

MS series

	 Pressure regulators MS2-LR, MS4-LR, MS6-LR, MS9-LR	 Pressure regulators MS12-LR
Pneumatic connection 1	G1/2, G1/4, G1/8, G3/8, M5, QS-6	Connecting plate
Standard nominal flow rate	170 ... 30000 l/min	12000 ... 22000 l/min
Pressure regulation range	0.3 ... 16 bar	0.15 ... 16 bar
Operating pressure	0.8 ... 20 bar	0.8 ... 21 bar
Max. pressure hysteresis	0.25 ... 0.4 bar	0.04 ... 0.4 bar
Description	<ul style="list-style-type: none"> • High flow rate with minimal pressure drop • Good control characteristics with minimal pressure hysteresis and primary pressure compensation • With or without secondary venting • Lockable rotary knob • Optional pressure sensor and rotary knob pressure gauge • Grid dimensions 25, 40, 62, 90 mm (size 2, 4, 6, 9) 	<ul style="list-style-type: none"> • High flow rate with minimal pressure drop • Good control characteristics with minimal pressure hysteresis and primary pressure compensation • With secondary venting • Lockable rotary knob • MS12-LR-...-PO: pneumatically actuated (pressure range determined via pilot control) • MS12-LR-...-PE6: electrically actuated (pilot control via proportional pressure regulator) • Grid dimensions 124 mm (size 12)
→ Page/online	260, 262	262

Pressure regulators > Classic >



D series, metal

	 Pressure regulators LR, LRS	 Pressure regulators LRB, LRBS	 Pressure regulator manifolds LRB-K
Pneumatic connection 1	G1, G1/2, G1/4, G1/8, G3/4, G3/8, M5, M7, QS-4, QS-6	Sub-base	G1/2, G1/4, G3/8
Standard nominal flow rate	120 ... 12500 l/min	1600 ... 3800 l/min	1600 ... 3800 l/min
Pressure regulation range	0.5 ... 12 bar	0.5 ... 12 bar	0.5 ... 12 bar
Operating pressure	0 ... 16 bar	1 ... 16 bar	1 ... 16 bar
Max. pressure hysteresis	0.2 ... 0.4 bar	0.2 bar	0.2 bar
Description	<ul style="list-style-type: none"> • Lockable design • Two pressure gauge connections for different installation options • Size micro, mini, midi: directly actuated diaphragm regulator • Size maxi: piloted piston regulator, diaphragm regulator LRS-DI • Optional return flow option for exhausting from output 2 to input 1 • Available with pressure gauge • Size micro, mini, midi, maxi 	<ul style="list-style-type: none"> • To build up a regulator manifold with through air supply for pressure ranges that can be adjusted independently of one another • Directly actuated diaphragm regulator • Settings secured via a detent on the rotary knob and push-in anti-tamper lock • Lockable design • Without pressure gauge • Size mini, midi 	<ul style="list-style-type: none"> • Regulator manifold with through air supply for pressure ranges that can be adjusted independently of one another • Directly actuated diaphragm regulator • Settings secured via a detent on the rotary knob and push-in anti-tamper lock • Without pressure gauge • Size mini, midi
→ Page/online	lr	lrb	lrb

Product overview



Pressure regulators >

D series, polymer

	 <p>Pressure regulators LR-DB</p>	 <p>Pressure regulator manifolds LRB-DB</p>
Pneumatic connection 1	G1/4, G1/8	G1/2
Standard nominal flow rate	≥800	≥1000
Pressure regulation range	0.5 ... 7 bar	0.5 ... 7 bar
Operating pressure	1.5 ... 10 bar	1.5 ... 10 bar
Max. pressure hysteresis	0.5 bar	0.5 bar
Description	<ul style="list-style-type: none"> • Set values are secured by locking the rotary knob • Available with pressure gauge • Size mini 	<ul style="list-style-type: none"> • Regulator manifold with through air supply for pressure ranges that can be adjusted independently of one another • Set values are secured by locking the rotary knob • Without pressure gauge • Size mini
→ Page/online	lr-db	lrb-db



On/off and soft-start valves >

MS series

	 <p>On/off valves MS4-EM1, MS6-EM1, MS9-EM, MS12-EM</p>	 <p>On/off valves MS4-EE, MS6-EE, MS9-EE, MS12-EE</p>	 <p>Soft-start valves MS4-DL, MS6-DL, MS12-DL</p>
Pneumatic connection 1	Manifold module, G1/2, G1/4, G1/8, G3/8, G3/4, G1	Manifold module, G1/2, G1/4, G1/8, G3/8, G3/4, G1	Manifold module, G1/2, G1/4, G1/8, G3/8
Standard nominal flow rate	1200 ... 32000 l/min	1000 ... 32000 l/min	1000 ... 42000 l/min
Operating pressure	0 ... 20 bar	3 ... 18 bar	2 ... 20 bar
Actuation type	Manual	Electrical	Pneumatic
Description	<ul style="list-style-type: none"> • Manual 3/2-way valve for pressurising and exhausting pneumatic systems • A silencer can be attached or the exhaust air can be ducted at port 3 • Switching position is immediately recognisable • Optionally with pressure gauge and pressure sensor • Grid dimensions 40, 62, 90, 124 mm (size 4, 6, 9, 12) 	<ul style="list-style-type: none"> • Electric 3/2-way valve for pressurising and exhausting pneumatic systems • A silencer can be attached or the exhaust air can be ducted at port 3 • Supply voltage 24 V DC, 110, 230 V AC • Optionally with pressure gauge and pressure sensor • With solenoid coil, without plug socket • Grid dimensions 40, 62, 90, 124 mm (size 4, 6, 9, 12) 	<ul style="list-style-type: none"> • 2/2-way valve for slowly pressurising pneumatic systems (for use with on/off valves EM(1) and EE) • For building up pressure gradually • Adjustable pressure build-up time • Grid dimensions 40, 62, 124 mm (size 4, 6, 12)
→ Page/online	264	264	266





On/off and soft-start valves >

MS series

	 Soft-start/quick exhaust valves MS6-SV-E, MS6-SV-D	 Soft-start/quick exhaust valves MS6-SV-C, MS9-SV-C
Pneumatic connection 1	G1/2	G1/2, G3/4, G1
Standard nominal flow rate	4300 l/min	5700 ... 16550 l/min
Operating pressure	3.5 ... 10 bar	3 ... 16 bar
Actuation type	Electrical	Electrical
Description	<ul style="list-style-type: none"> Reliable 2-channel exhausting with self-monitoring up to Performance Level e and category 4 to EN ISO 13849-1 For reducing pressure quickly and reliably and for building up pressure gradually SIL 3 Adjustable pressure build-up time Optionally with silencer Supply voltage 24 V DC Grid dimensions 62 mm (size 6) 	<ul style="list-style-type: none"> Single-channel exhausting up to Performance Level c and category 1 to EN ISO 13849-1 For reducing pressure quickly and reliably and for building up pressure gradually Adjustable pressure build-up time Adjustable switch-through pressure Supply voltage 24 V DC Grid dimensions 62, 90 mm (size 6, 9)
→ Page/online	ms6-sv-e	266

On/off and soft-start valves > Classic >

D series

	 On/off valves HE	 On/off valves HEE	 On/off valves HEP	 Soft-start valves HEL
Pneumatic connection 1	G1, G1/2, G1/4, G1/8, G3/4, G3/8	G1, G1/2, G1/4, G1/8, G3/4, G3/8	G1, G1/2, G1/4, G1/8, G3/4, G3/8	G1, G1/2, G1/4, G1/8, G3/4, G3/8
Standard nominal flow rate	1000 ... 10000 l/min	1000 ... 6500 l/min	1000 ... 6500 l/min	1000 ... 6500 l/min
Operating pressure	0 ... 16 bar	2.5 ... 16 bar	0 ... 16 bar	3 ... 16 bar
Actuation type	Manual	Electrical	Pneumatic	Pneumatic
Description	<ul style="list-style-type: none"> Manual 3/2-way valve for pressurising and exhausting pneumatic systems A silencer can be attached or the exhaust air can be ducted at port 3 The switching position is immediately recognisable Size mini, midi, maxi 	<ul style="list-style-type: none"> Electric 3/2-way valve for pressurising and exhausting pneumatic systems A silencer can be attached or the exhaust air can be ducted at port 3 With solenoid coil, without plug socket Solenoid actuator can be repositioned by 4x 90° Detenting and non-detenting manual override Supply voltage 24 V DC, 110, 230 V AC Size mini, midi, maxi 	<ul style="list-style-type: none"> Pneumatic 3/2-way valve for pressurising and exhausting pneumatic systems Especially suitable for applications requiring explosion protection Size mini, midi, maxi 	<ul style="list-style-type: none"> 2/2-way valve for slowly pressurising pneumatic systems (for use with on/off valves HE and HEE) For building up pressure gradually Adjustable pressure build-up time Size mini, midi, maxi
→ Page/online	he	hee	hep	hel

Product overview

On/off and soft-start valves >

D series, polymer



On/off valves
HE-DB

Pneumatic connection 1	G1/4
Standard nominal flow rate	2300 l/min
Operating pressure	0 ... 10 bar
Actuation type	Manual
Description	<ul style="list-style-type: none"> • 3/2-way manual on-off valve • Switching position is immediately recognisable • Commercially available padlock for security
→ Page/online	he-db

Compressed air distributors >

MS series



Branching modules
MS4-FRM, MS6-FRM, MS9-FRM, MS12-FRM





Distributor blocks
MS4-FRM-FRZ, MS6-FRM-FRZ

Pneumatic connection 1	Manifold module, G1/4, G1/2, G1, G2, G1, G1 1/2, G1 1/4, G1/2, G1/4, G1/8, G3/4, G3/8, NPT1 1/2-11 1/2, NPT1 1/4-11 1/2, NPT1-11 1/2, NPT1/2-14, NPT3/4-14, NPT1-11 1/2	G1/4, G1/2
Standard nominal flow rate in main flow direction 1->2	1200 ... 50000 l/min	4050 ... 14600 l/min
Operating pressure	0 ... 20 bar	0 ... 20 bar
Description	<ul style="list-style-type: none"> • Optionally with integrated non-return function and pressure sensor • Outlet at top and bottom • Can be used as an intermediate distributor for varying air qualities • Optionally with pressure sensor • Grid dimensions 40, 62, 90, 124 mm (size 4, 6, 9, 12) 	<ul style="list-style-type: none"> • Slim pneumatic distributor • Outlet at top and bottom • Can be used as an intermediate distributor for varying air qualities • Can be used as an adapter between two pressure regulators with large rotary knob with pressure gauge on size MS4 • Grid dimensions 40, 62 mm (size 4, 6)
→ Page/online	268	270

Compressed air distributors > Classic >

D series

	 Branching modules FRM	 Distributor blocks FRZ
Pneumatic connection 1	G1, G1/2, G1/4, G1/8, G3/4, G3/8	Manifold module
Standard nominal flow rate in main flow direction 1->2	1100 ... 20000 l/min	
Operating pressure	0 ... 16 bar	
Description	<ul style="list-style-type: none"> • Outlet at top and bottom • Can be used as an intermediate distributor for varying air qualities • Optionally with integrated non-return function and pressure sensor • Size mini, midi, maxi 	<ul style="list-style-type: none"> • Outlet at top and bottom • Can be used as an intermediate distributor for varying air qualities • Slim pneumatic distributor • Size micro, mini, midi, maxi
→ Page/online	frm	frz

Accessories >

MS series

	 Connecting plates MS4-AG..., MS6-AG...
Pneumatic connection 1	G1/4, G3/8, G1/2, G3/4
Pneumatic connection 2	G1/4, G3/8, G1/2, G3/4
Description	<ul style="list-style-type: none"> • Accessories for size MS4, MS6 • Adapter for pneumatic connection
→ Page/online	271

Customised components – for your specific requirements



Components for compressed air preparation with customised designs
Can't find the compressed air preparation components you need in our catalogue?

We offer you customised components that are tailored to your specific requirements.

Common product modifications:

- Modified pressure range
- Rotary knob: in a special colour, with protection against rotation
- Fitting: integrated throttling port, special thread
- Tubing with special printing
- Pressure gauge with red-green range

Many additional variants are possible.

Ask your Festo sales engineer, who will be happy to help:

→ www.festo.com/contact

Service units > MS series >

Service units MSB4/MSB6, MS series



- For filtered and unlubricated compressed air
- Supply pressure can be opened and closed
- Output pressure is infinitely adjustable within the pressure regulation range
- Flow rate 950 ... 5500 l/min
- Operating pressure 0.8 ... 18 bar
- Grade of filtration 40 µm
- Manual rotary condensate drain

Combinations comprising:

- ① Manually operated on/off valve, filter regulator with lockable pressure gauge, mounting bracket
- ② Manually operated on/off valve, filter regulator with lockable pressure gauge, branching module with pressure switch, mounting bracket

- ③ Manually operated on/off valve, filter regulator with lockable pressure gauge, electrically actuated on/off valve with pressure sensor for operational status indicator, mounting bracket

Order code – Basic design

001 002 003 004 005 006
MSB - : : **C3** : **J1** : - **WP**

Legend: Mandatory entry Optional entry

001	Type
MSB	Service unit
002	Size
4	Grid dimension 40 mm
6	Grid dimension 62 mm
003	Pneumatic connection
1/4	G1/4 thread
1/2	G1/2 thread
004	Direction of flow
-	From left to right

005	Service unit
C3	On/off valve MS4-EM1, MS6-EM1
J1	Filter regulator MS4-LFR-D7-ERM-AS, MS6-LFR-D7-ERM-AS
D14	On/off valve MS4-EE-10V24P-AD7, MS6-EE-10V24P-AD7
F12	Branching module MS4-FRM-AD7, MS6-FRM-AD7
006	Type of mounting
WP	Mounting bracket

Product options

- Additional connection sizes
- Connecting plates
- Grade of filtration 5 µm
- Service unit components: filter regulators, soft-start valves, lubricators, on/off valves
- Alternative direction of flow
- Fully automatic condensate drain

Configurable product

This product and all its product options can be ordered online via the configurator:

→ www.festo.com/catalogue/...

Enter the part number or the type.

Part no.	Type	Standard nominal flow rate	Pressure regulation range	Grade of filtration
531029	MSB4	800 ... 1400 l/min	1 ... 12 bar	0.01 ... 40 µm
531030	MSB6	1700 ... 4800 l/min	1 ... 12 bar	0.01 ... 40 µm

Ordering – Basic design

002 Size	003 Pneumatic connection	Condensate drain	Grade of filtration	Type	Part no.
① Manually operated on/off valve, filter regulator with lockable pressure gauge, mounting bracket Pressure regulation range 0.5 ... 12 bar, pressure gauge with outer scale in bar and inner scale in psi					
4	G1/4	Manual rotary	40 µm	MSB4-1/4:C3J1-WP	8025354
6	G1/2	Manual rotary	40 µm	MSB6-1/2:C3J1-WP	8025355
② Manually operated on/off valve, filter regulator with lockable pressure gauge, branching module with pressure sensor, mounting bracket Pressure regulation range 0.5 ... 10 bar, pressure gauge with outer scale in bar and inner scale in psi					
4	G1/4	Manual rotary	40 µm	MSB4-1/4:C3J1F12-WP	8025356
6	G1/2	Manual rotary	40 µm	MSB6-1/2:C3J1F12-WP	8025357
③ Manually operated on/off valve, filter regulator with lockable pressure gauge, electrically actuated on/off valve with pressure sensor, mounting bracket Pressure regulation range 0.5 ... 10 bar, pressure gauge with outer scale in bar and inner scale in psi					
4	G1/4	Manual rotary	40 µm	MSB4-1/4:C3J1D14-WP	8025358
6	G1/2	Manual rotary	40 µm	MSB6-1/2:C3J1D14-WP	8025359

Accessories

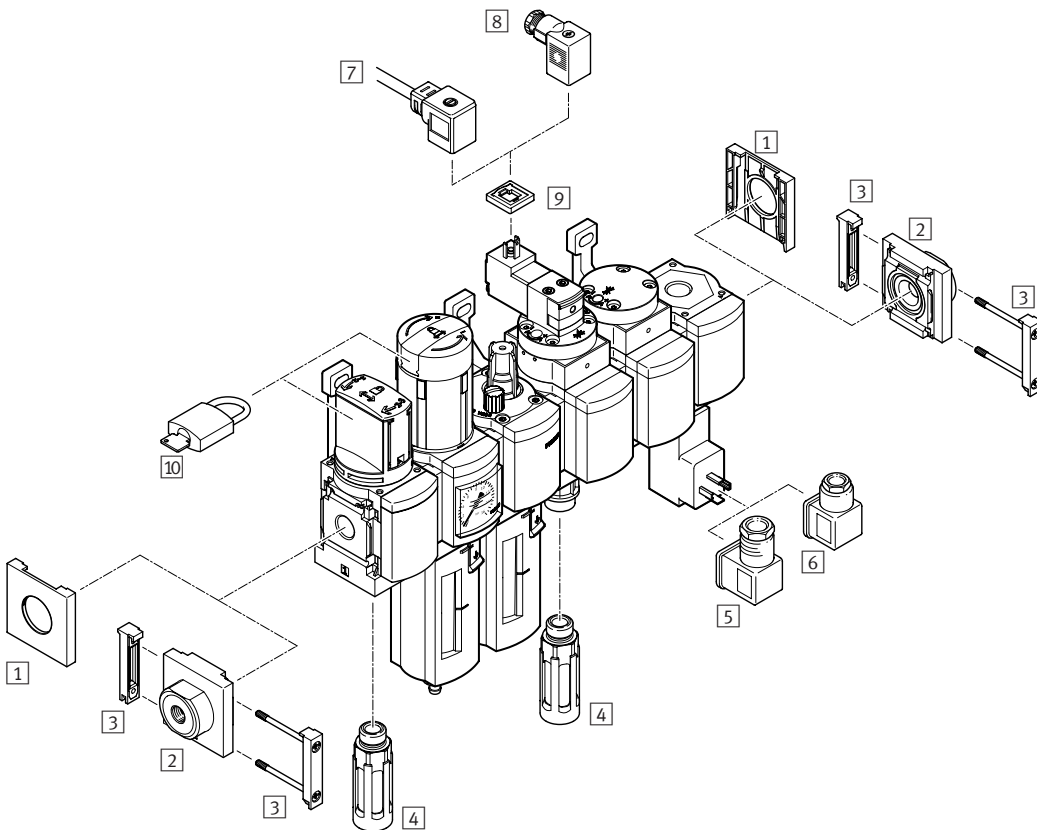

- 1 Cover cap MS4/6-END
→ [ms4-end](#)
- 2 Connecting plate kit MS4/6-AG...
→ 271
- 3 Module connector MS4/6-MV
→ 253
- 4 Silencer U-B → 317
- 5 Angled socket PEV-1/4-WD-LED
→ [msb](#)
- 6 Plug socket MSSD-C-4P → [msb](#)
- 7 Plug socket with cable KMEB-3
→ [msb](#)
- 8 Plug socket MSSD-EB → [msb](#)
- 9 Illuminating seal MEB-LD → [msb](#)
- 10 Padlock LRVS-D → [msb](#)

Mounting bracket
MS4/MS6-WP, MS4/MS6-WPB,
MS4/MS6-WPM → 253
MS4/6-WPE → [ms4-wpe](#)

3 Module connector MS4/6-MV		
Size	Type	Part no.
4	MS4-MV	532798
6	MS6-MV	532799

Mounting bracket MS4/6-WP		
Size	Type	Part no.
For wall mounting		
4	MS4-WP	532184
6	MS6-WP	532195

Mounting bracket MS4/6-WPB		
Size	Type	Part no.
For wall mounting		
4	MS4-WPB	526063
6	MS6-WPB	526074

Mounting bracket MS4/6-WPM		
Size	Type	Part no.
For wall mounting		
4	MS4-WPM-D	526060
6	MS6-WPM-D	526073

Filter regulators/lubricators > MS series >

Service units MSB4/MSB6-FRC, MS series



- Filter, regulator and lubricator functions in a single unit
- High flow rate and highly efficient in removing contaminants
- Good control characteristics with minimal pressure hysteresis
- Set values are secured by locking the rotary knob
- Flow rate 850 ... 4800 l/min
- Operating pressure 1.5 ... 20 bar
- Grade of filtration 40 µm
- Manual rotary condensate drain

Order code – Basic design

001 002 003 004 005 006
MSB - - **FRC5:J1** **M1** -

Legend: Mandatory entry Optional entry

001	Type
MSB	Service unit

005	Lubricator
M1	Plastic bowl guard

002	Size
4	Grid dimension 40 mm
6	Grid dimension 62 mm

006	Direction of flow
-	From left to right

003	Pneumatic connection
1/4	G1/4 thread
1/2	G1/2 thread

004	Service unit
FRC5:J1	<ul style="list-style-type: none"> • Filter regulator with pressure gauge, rotary knob with detent, can be locked using accessories, plastic bowl with plastic bowl guard • Lubricator • Pressure regulation range 0.5 ... 12 bar • Plastic bowl with plastic bowl guard • Grade of filtration 40 µm • Manual rotary condensate drain • Pressure gauge with outer scale in bar and inner scale in psi

Product options

- Additional connection sizes
- Grade of filtration 5 µm
- Pressure regulation range 0.3 ... 7 bar
- Metal bowl guard for filter regulator and for lubricator
- Fully automatic condensate drain

 Configurable product

This product and all its product options can be ordered online via the configurator:

→ www.festo.com/catalogue/msb

Ordering – Basic design

002 Size	003 Pneumatic connection	Standard nominal flow rate	Pressure regulation range	Grade of filtration	Type	Part no.
Grade of filtration 40 µm, manual rotary condensate drain						
4	G1/4	900 l/min	0.5 ... 12 bar	40 µm	MSB4-1/4-FRC5:J1M1	531117
6	G1/2	3700 l/min	0.5 ... 12 bar	40 µm	MSB6-1/2-FRC5:J1M1	530244

Accessories

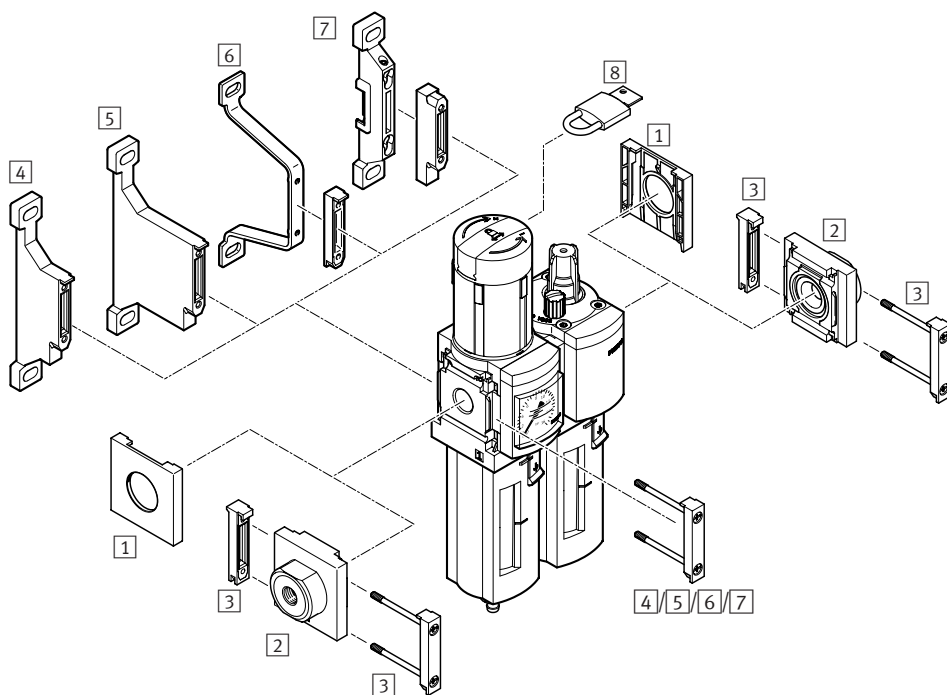

- 1 Cover cap MS4/6-END
→ [ms4-end](#)
- 2 Connecting plate kit MS4/6-AG...
→ 271
- 3 Module connector MS4/6-MV
→ 255
- 4 Mounting bracket MS4/6-WP
→ 255
- 5 Mounting bracket MS4/6-WPB
→ 255
- 6 Mounting bracket MS4/6-WPE
→ [ms4-wpe](#)
- 7 Mounting bracket MS4/6-WPM
→ 255
- 8 Padlock LRVS-D → [msb](#)

3 Module connector MS4/6-MV		
Size	Type	Part no.
4	MS4-MV	532798
6	MS6-MV	532799

4 Mounting bracket MS4/6-WP		
Size	Type	Part no.
For wall mounting		
4	MS4-WP	532184
6	MS6-WP	532195

5 Mounting bracket MS4/6-WPB		
Size	Type	Part no.
For wall mounting		
4	MS4-WPB	526063
6	MS6-WPB	526074

7 Mounting bracket MS4/6-WPM		
Size	Type	Part no.
For wall mounting		
4	MS4-WPM-D	526060
6	MS6-WPM-D	526073

Filter regulators > MS series >

Filter regulators MS2-LFR-B, MS series



- Filter and pressure regulator in a single unit
- Good regulation characteristics with minimal hysteresis and primary pressure compensation
- Good particle and condensate separation
- Flow rate 140 ... 310 l/min
- Operating pressure 1 ... 10 bar
- Grade of filtration 5 µm
- Manual rotary condensate drain

Order code

001	002	003	004	005	006	007	008	009	010
MS	2	LFR		D6			C	M	B

Legend: Mandatory entry Optional entry

001	Type
MS	Standard service unit
002	Size
2	Grid dimension 25 mm
003	Service function
LFR	Filter regulator
004	Pneumatic connection
M5	Female thread M5
QS6	Push-in connector for tubing O.D. 6 mm
005	Pressure regulation range
D6	Pressure regulation range 0.5 ... 7 bar
006	Pressure gauge/adaptor
A8	Adapter plate for EN pressure gauge 1/8, without pressure gauge
AR	Pressure gauge

007	Pressure gauge scale
-	Without
BAR	Display unit [bar/psi]
MPA	Display unit [MPa]
008	Grade of filtration
C	5 µm
009	Condensate drain
M	Manual rotary
010	Version
B	Basic

Ordering

005 Pressure regulation range 0.5 ... 7 bar, 008 Grade of filtration 5 µm, 009 Manual rotary condensate drain, rotary knob with detent					
002 Size	004 Pneumatic connection 1, 2	006 Pressure gauge/adaptor plate	007 Pressure gauge scale	Type	Part no.
2	M5	With adapter plate for EN pressure gauge 1/8, without pressure gauge	Without	MS2-LFR-M5-D6-A8-C-M-B	8086643
	QS-6			MS2-LFR-QS6-D6-A8-C-M-B	8086646
	M5	With pressure gauge	Display unit [bar/psi]	MS2-LFR-M5-D6-AR-BAR-C-M-B	8086641
	QS-6			MS2-LFR-QS6-D6-AR-BAR-C-M-B	8086644
	M5	With pressure gauge	Display unit [MPa]	MS2-LFR-M5-D6-AR-MPA-C-M-B	8086642
	QS-6			MS2-LFR-QS6-D6-AR-MPA-C-M-B	8086645

Accessories

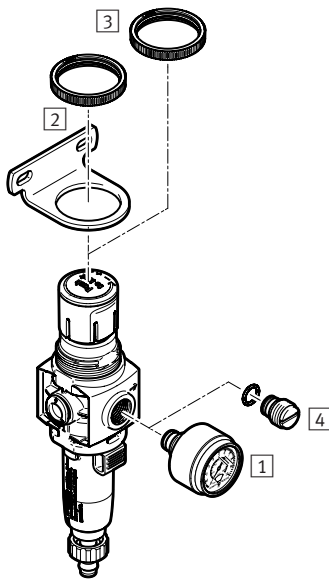

- 1 Pressure gauge PAGN → 257
- 2 Mounting bracket MS2-WR → 257
- 3 Nut MS2-WRS → 257
- 4 Plug screw MS2-G18S → 257

Filter cartridge LFP → 257

1 Pressure gauge PAGN				
Operating pressure	Outer scale	Inner scale	Type	Part no.
0 ... 10 bar	0 ... 10 bar	0 ... 145 psi	PAGN-23-10-G18S	8088991
0 ... 1 MPa	0 ... 1 MPa	–	PAGN-23-1M-G18S	8088992

2 Mounting bracket MS2-WR ¹⁾			
Size	Type		Part no.
2	MS2-WR		8087978

1) Knurled nut included in the scope of delivery

3 Nut MS2-WRS for front panel mounting			
Size	Type		Part no.
2	MS2-WRS		8098037

4 Plug screw MS2-G18S			
Size	Type		Part no.
2	MS2-G18S		8095766

Filter cartridge LFP			
Size	Grade of filtration [µm]	Type	Part no.
2	5	LFP-D-MICRO-5M	526818

Filter regulators > MS series >

Filter regulators MS4/MS6/MS12-LFR, MS series



- Filter and pressure regulator in a single unit
- Good regulation characteristics with minimal hysteresis and primary pressure compensation
- Good particle and condensate separation
- Flow rate 850 ... 17000 l/min
- Operating pressure 0.8 ... 20 bar
- Grade of filtration 5 µm, 40 µm
- Manual rotary, fully automatic condensate drain

Order code

001 002 003 004 005 006 007 008 009 010
 MS [] - LFR [] - [] - [] - [] - [] - AS []

Legend: Mandatory entry Optional entry

001	Type
MS	Standard service unit
002	Size
4	Grid dimension 40 mm
6	Grid dimension 62 mm
12	Grid dimension 124 mm
003	Service function
LFR	Filter regulator
004	Pneumatic connection
1/4	Female thread G1/4
1/2	Female thread G1/2
005	Pressure regulation range
D6	Pressure regulation range 0.3 ... 7 bar
D7	Pressure regulation range 0.5 ... 12 bar

006	Grade of filtration
C	5 µm
E	40 µm
007	Bowl guard
R	Plastic bowl guard
U	Integrated as metal bowl
008	Condensate drain
M	Manual rotary
V	Fully automatic
009	Lockable
AS	Rotary knob with detent, can be locked using accessories
010	Direction of flow
-	From left to right

Product options

- Size: 9
- Pneumatic connection
- Pressure regulation range
- Condensate drain
- Pressure gauge alternatives
- Alternative pressure gauge scale
- Secondary exhaust
- Rotary knob
- Lockable
- Type of mounting
- EU certification
- UL certification
- Direction of flow

Configurable product

This product and all its product options can be ordered online via the configurator:

→ www.festo.com/catalogue/...

Enter the part number or the type.

Part no.	Type	Standard nominal flow rate	Pressure regulation range	Grade of filtration
526489	MS4-LFR	850 ... 1800 l/min	0.3 ... 12 bar	5 µm, 40 µm
526490	MS6-LFR	2000 ... 7200 l/min	0.3 ... 16 bar	5 µm, 40 µm
535022	MS12-LFR	11000 ... 17000 l/min	0.3 ... 16 bar	5 µm, 40 µm

Ordering – Basic design

			006 Grade of filtration 5 µm		006 Grade of filtration 40 µm	
002 Size	004 Pneumatic connection	008 Condensate drain	Type	Part no.	Type	Part no.
Pressure regulation range 0.3 ... 7 bar, integrated pressure gauge, display unit [bar], standard rotary knob with detent, can be locked using accessories, plastic bowl guard						
4	G1/4	Manual rotary	MS4-LFR-1/4-D6-CRM-AS	529144	MS4-LFR-1/4-D6-ERM-AS	529148
			Fully automatic	MS4-LFR-1/4-D6-CRV-AS	529146	MS4-LFR-1/4-D6-ERV-AS
6	G1/2	Manual rotary	MS6-LFR-1/2-D6-CRM-AS	529176	MS6-LFR-1/2-D6-ERM-AS	529180
			Fully automatic	MS6-LFR-1/2-D6-CRV-AS	529178	MS6-LFR-1/2-D6-ERV-AS
Pressure regulation range 0.5 ... 12 bar, integrated pressure gauge, display unit [bar], standard rotary knob with detent, can be locked using accessories, plastic bowl guard						
4	G1/4	Manual rotary	MS4-LFR-1/4-D7-CRM-AS	529152	MS4-LFR-1/4-D7-ERM-AS	529156
			Fully automatic	MS4-LFR-1/4-D7-CRV-AS	529154	MS4-LFR-1/4-D7-ERV-AS
6	G1/2	Manual rotary	MS6-LFR-1/2-D7-CRM-AS	529184	MS6-LFR-1/2-D7-ERM-AS	529188
			Fully automatic	MS6-LFR-1/2-D7-CRV-AS	529186	MS6-LFR-1/2-D7-ERV-AS
Pressure regulation range 0.5 ... 12 bar, integrated pressure gauge, display unit [bar], standard rotary knob with detent, can be locked using accessories, integrated as metal bowl						
4	G1/4	Manual rotary			MS4-LFR-1/4-D7-EUM-AS	535724
			Fully automatic	MS4-LFR-1/4-D7-CUV-AS	535720	MS4-LFR-1/4-D7-EUV-AS
6	G1/2	Manually rotating			MS6-LFR-1/2-D7-EUM-AS	529192
			Fully automatic	MS6-LFR-1/2-D7-CUV-AS	530340	MS6-LFR-1/2-D7-EUV-AS

Accessories

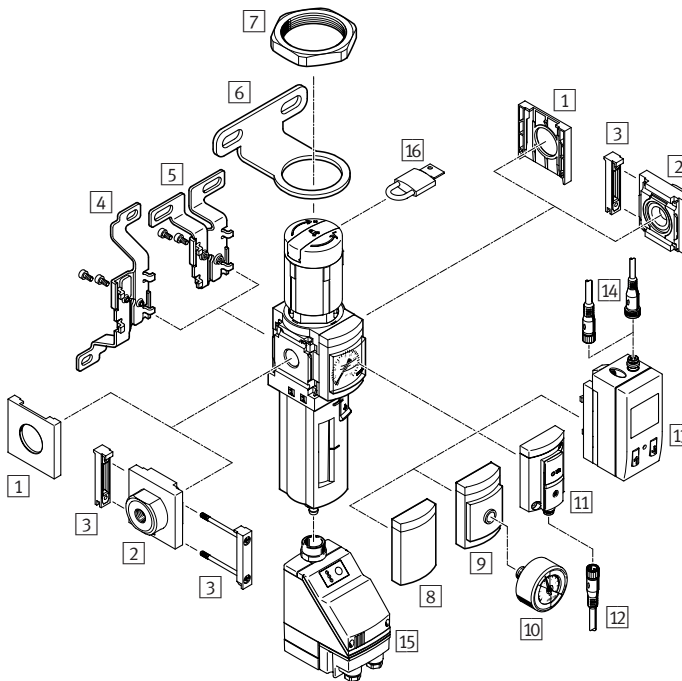

- 1 Cover cap MS4/6-END → [ms4-end](#)
 - 2 Connecting plate kit MS4/6-AG... → 271
 - 3 Module connector MS4/6-MV → 259
 - 4 Mounting bracket MS4/6-WB → 259
 - 5 Mounting bracket MS4/6-WBM → [ms4-wbm](#)
 - 6 Mounting bracket MS4/6-WR → 259
 - 7 Hex nut MS4/6-WRS → [ms4-wrs](#)
 - 8 Cover plate VS → [ms4-lfr](#)
 - 9 Adapter plate for EN pressure gauge → [ms4-lfr](#)
 - 10 Pressure gauge MA → [ms4-lfr](#)
 - 11 Pressure sensor without display → [ms4-lfr](#)
 - 12 Connecting cable NEBU-M8...-LE3 → 279
 - 13 Pressure sensor with display → [ms4-lfr](#)
 - 14 Connecting cable NEBU-M8...-LE3/NEBU-M12...-LE4 → 279
 - 15 Fully automatic condensate drain, electrically actuated → [ms4-lfr](#)
 - 16 Padlock LRVS-D → [ms4-lfr](#)
- Mounting bracket
MS4/MS6-WP, MS4/MS6-WPB,
MS4/MS6-WPM → 259
MS4/6-WPE → [ms4-wpe](#)

3 Module connector MS-MV		
Size	Type	Part no.
4	MS4-MV	532798
6	MS6-MV	532799

4 Mounting bracket MS-WB		
Size	Type	Part no.
For wall mounting		
4	MS4-WB	532185
6	MS6-WB	532196

Mounting bracket MS-WP		
Size	Type	Part no.
For wall mounting		
4	MS4-WP	532184
6	MS6-WP	532195

Mounting bracket MS-WPM		
Size	Type	Part no.
For wall mounting		
4	MS4-WPM-D	526060
6	MS6-WPM-D	526073

Module connector MS-MVM		
Size	Type	Part no.
For installing modules with regulating knob pointing downwards		
4	MS4-MVM	532800
6	MS6-MVM	532801

6 Mounting bracket MS-WR		
Size	Type	Part no.
For wall mounting		
4	MS4-WR	526064
6	MS6-WR	526075

Mounting bracket MS-WPB		
Size	Type	Part no.
For wall mounting		
4	MS4-WPB	526063
6	MS6-WPB	526074

Regulators > MS series >

Pressure regulators MS2-LR-B, MS series



- Maintains a constant working pressure independent of pressure fluctuations and air consumption
- Connection M5, QS-6
- Flow rate 170 ... 350 l/min
- Operating pressure 1 ... 10 bar
- Grade of filtration 5 µm
- Manual rotary condensate drain

Order code

001 002 003 004 005 006 007 008
MS **2** - **LR** - - **D6** - - - **B**

Legend: Mandatory entry Optional entry

001	Type
MS	Standard service unit
002	Size
2	Grid dimension 25 mm
003	Service function
LR	Pressure regulator
004	Pneumatic connection
M5	Female thread M5
QS6	Push-in connector for tubing O.D. 6 mm
005	Pressure regulation range
D6	Pressure regulation range 0.5 ... 7 bar
006	Pressure gauge/adaptor
A8	With adapter plate for EN pressure gauge <input type="checkbox"/> , without pressure gauge
AR	With pressure gauge

007	Pressure gauge scale
-	Without
BAR	Display unit [bar/psi]
MPA	Display unit [MPa]
008	Version
B	Basic

Ordering

005 Pressure regulation range 0.5 ... 7 bar, rotary knob with detent					
002 Size	004 Pneumatic connection 1, 2	006 Pressure gauge/adaptor plate	007 Pressure gauge scale	Type	Part no.
2	M5	With adapter plate for EN pressure gauge <input type="checkbox"/> , without pressure gauge	Without	MS2-LR-M5-D6-A8-B	8086637
	QS-6			MS2-LR-QS6-D6-A8-B	8086640
	M5	With pressure gauge	Display unit [bar/psi]	MS2-LR-M5-D6-AR-BAR-B	8086628
	QS-6			MS2-LR-QS6-D6-AR-BAR-B	8086638
	M5	With pressure gauge	Display unit [MPa]	MS2-LR-M5-D6-AR-MPA-B	8086636
	QS-6			MS2-LR-QS6-D6-AR-MPA-B	8086639

Accessories

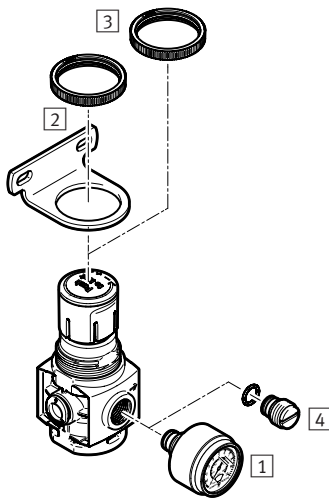

- 1 Pressure gauge PAGN → 261
- 2 Mounting bracket MS2-WR
→ 261
- 3 Nut MS2-WRS → 261
- 4 Plug screw MS2-G18S → 261

1 Pressure gauge PAGN				
Operating pressure	Outer scale	Inner scale	Type	Part no.
0 ... 10 bar	0 ... 10 bar	0 ... 145 psi	PAGN-23-10-G18S	8088991
0 ... 1 MPa	0 ... 1 MPa	–	PAGN-23-1M-G18S	8088992

2 Mounting bracket MS2-WR ¹⁾		
Size	Type	Part no.
2	MS2-WR	8087978

1) Knurled nut included in the scope of delivery

3 Nut MS2-WRS		
Size	Type	Part no.
2	MS2-WRS	8098037

4 Plug screw MS2-G18S		
Size	Type	Part no.
2	MS2-G18S	8095766

Regulators > MS series >

Pressure regulators MS4/MS6/MS12-LR, MS series



- Maintains a constant working pressure independent of pressure fluctuations and air consumption
- High flow rate with minimal pressure drop
- Connection G1/4, G1/2
- Flow rate 1000 ... 22000 l/min
- Operating pressure 0.8 ... 20 bar
- Selected types in accordance with ATEX directive for potentially explosive atmospheres
→ www.festo.com/ex

Order code

001 002 003 004 005 006 007
 MS [] - LR [] - [] - AS []

Legend: Mandatory entry Optional entry

001	Type
MS	Standard service unit
002	Size
4	Grid dimension 40 mm
6	Grid dimension 62 mm
12	Grid dimension 124 mm
003	Service function
LR	Pressure regulator
004	Pneumatic connection
1/4	Female thread G1/4
1/2	Female thread G1/2

005	Pressure regulation range
D5	0.3 ... 4 bar, manually actuated
D6	0.3 ... 7 bar, manually actuated
D7	0.5 ... 12 bar, manually actuated
006	Lockable
AS	Standard rotary knob with detent, can be locked using accessories
007	Direction of flow
-	From left to right

Product options

- Size: 9
- Pneumatic connection
- Connecting plates
- Pressure regulation range/operation
- Pressure gauge alternatives
- Alternative pressure gauge scale
- Secondary exhaust
- Lockable
- Type of mounting
- EU certification
- UL certification
- Alternative direction of flow

Configurable product

This product and all its product options can be ordered online via the configurator:

→ www.festo.com/catalogue/...

Enter the part number or the type.

Part no.	Type	Standard nominal flow rate	Pressure regulation range	Max. pressure hysteresis
527690	MS4-LR	1000 ... 2100 l/min	0.3 ... 12 bar	0.25 bar
527663	MS6-LR	2200 ... 7500 l/min	0.3 ... 16 bar	0.25 bar
535021	MS12-LR	12000 ... 22000 l/min	0.15 ... 16 bar	0.04 bar/0.4 bar

Ordering – Basic design

		005 Pressure regulation range 0.3 ... 4 bar		005 Pressure regulation range 0.3 ... 7 bar		005 Pressure regulation range 0.5 ... 12 bar	
002 Size	004 Pneumatic connection	Type	Part no.	Type	Part no.	Type	Part no.
Integrated pressure gauge, display unit [bar], standard rotary knob with detent, can be locked using accessories							
4	G1/4	MS4-LR-1/4-D5-AS	529415	MS4-LR-1/4-D6-AS	529417	MS4-LR-1/4-D7-AS	529419
6	G1/2	MS6-LR-1/2-D5-AS	529989	MS6-LR-1/2-D6-AS	529991	MS6-LR-1/2-D7-AS	529993

Accessories

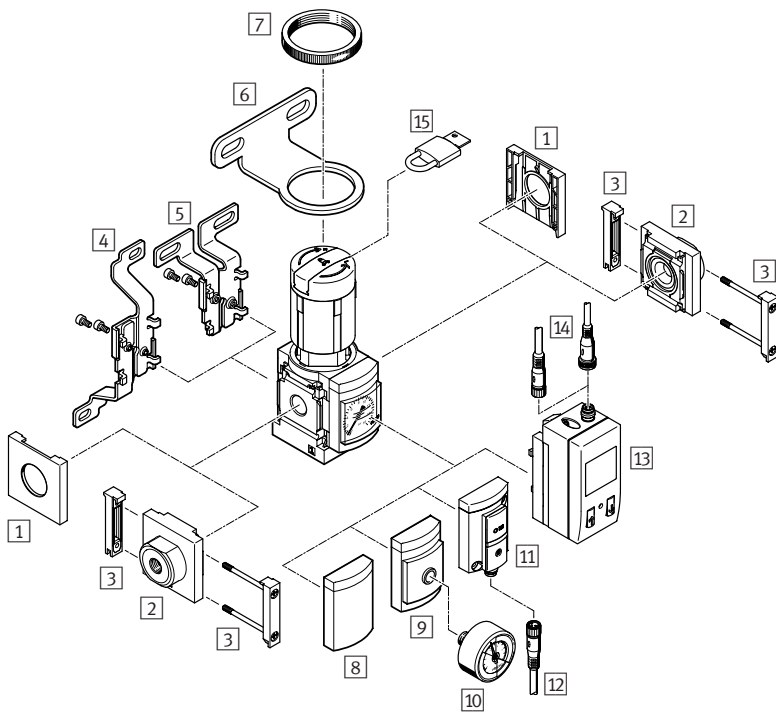

- 1 Cover cap MS4/6-END → [ms4-end](#)
- 2 Connecting plate kit MS4/6-AG... → 271
- 3 Module connector MS4/6-MV → 259
- 4 Mounting bracket MS4/6-WB → 259
- 5 Mounting bracket MS4/6-WBM → [ms4-wbm](#)
- 6 Mounting bracket MS4/6-WR → 259
- 7 Knurled nut MS-LR (included in the scope of delivery)
- 8 Cover plate VS → [ms4-lr](#)
- 9 Adapter plate for EN pressure gauge → [ms4-lr](#)
- 10 Pressure gauge MA → [ms4-lr](#)
- 11 Pressure sensor without display → [ms4-lr](#)
- 12 Connecting cable NEBU-M8...-LE3 → 279
- 13 Pressure sensor with display → [ms4-lr](#)
- 14 Connecting cable NEBU-M8...-LE3/
NEBU-M12...-LE4 → 279
- 15 Padlock LRVS-D → [ms4-lr](#)

Mounting bracket
MS4/MS6-WP, MS4/MS6-WPB, MS4/MS6-WPM
→ 259
MS4/6-WPE → [ms4-wpe](#)

On/off valves and soft-start valves > MS series > Manually/electrically actuated on/off valves > On/off valves MS4/MS6-EM1, MS4/MS6-EE, MS series



- For pressurising and exhausting pneumatic systems
- Connection G1/4, G1/2
- Flow rate 1000 ... 8700 l/min
- Operating pressure 0 ... 18 bar
- Selected types in accordance with ATEX directive for potentially explosive atmospheres
→ www.festo.com/ex

Order code – Basic design

001 002 003 004 005 006
 MS - - - - -

Legend: Mandatory entry Optional entry

001	Type
MS	Standard service unit
002	Size
4	Grid dimension 40 mm
6	Grid dimension 62 mm
003	Service function
EM1	Manually operated on/off valve
EE	Electrically actuated on/off valve
004	Pneumatic connection
1/4	Female thread G1/4
1/2	Female thread G1/2

005	Supply voltage
-	Without (manually operated on/off valve)
10V24	Supply voltage 24 V DC
006	Silencers
-	Without silencer
S	With silencer

Product options

- Additional connection sizes
- Silencer
- Connecting plates
- Pressure gauge/pressure gauge alternatives
- Alternative pressure gauge scale
- Supply voltage
- Type of mounting
- Valve function
- EU certification
- UL certification
- Direction of flow

Configurable product

This product and all its product options can be ordered online via the configurator:

→ www.festo.com/catalogue/ms4-e

Ordering – Basic design

		006 Without silencer		006 With silencer	
002 Size	004 Pneumatic connection	Type	Part no.	Type	Part no.
003 Manually operated on/off valve					
4	G1/4	MS4-EM1-1/4	541258	MS4-EM1-1/4-S	541259
6	G1/2	MS6-EM1-1/2	541267	MS6-EM1-1/2-S	541268
003 Electrically actuated on/off valve					
005 Supply voltage 24 V DC					
4	G1/4	MS4-EE-1/4-10V24	542578	MS4-EE-1/4-10V24-S	542598
6	G1/2	MS6-EE-1/2-10V24	542582	MS6-EE-1/2-10V24-S	542602

Accessories

MS4/MS6-EM1

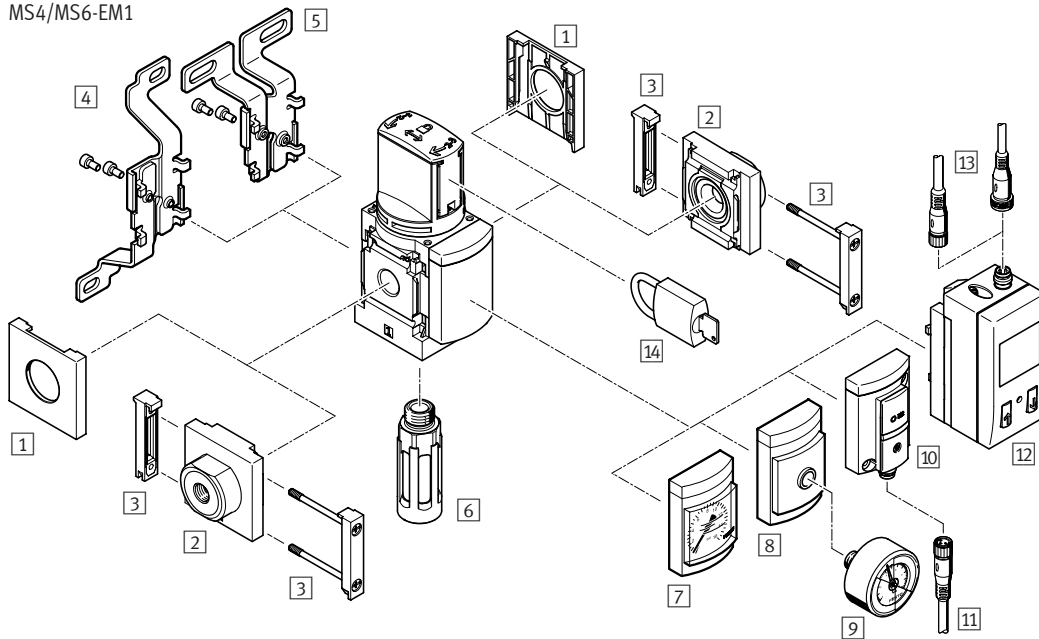

- 1 Cover cap MS4/6-END
→ [ms4-end](#)
- 2 Connecting plate kit MS4/6-AG...
→ 271
- 3 Module connector MS4/6-MV
→ 259
- 4 Mounting bracket MS4/6-WB
→ 259
- 5 Mounting bracket MS4-WBM
→ [ms4-wbm](#)
- 6 Silencer U-B → 317
- 7 MS pressure gauge → [ms4-e](#)
- 8 Adapter plate for EN pressure
gauge → [ms4-e](#)
- 9 Pressure gauge MA → [ms4-e](#)
- 10 Pressure sensor without display
→ [ms4-e](#)
- 11 Connecting cable NEBU-M8...-LE3
→ 279
- 12 Pressure sensor with display
→ [ms4-e](#)
- 13 Connecting cable NEBU-M8...-LE3/
NEBU-M12...-LE4 → 279
- 14 Padlock LRVS-D → [ms4-e](#)

Mounting bracket
MS4/MS6-WP, MS4/MS6-WPB,
MS4/MS6-WPM → 259
MS4/6-WPE → [ms4-wpe](#)

MS4/MS6-EE

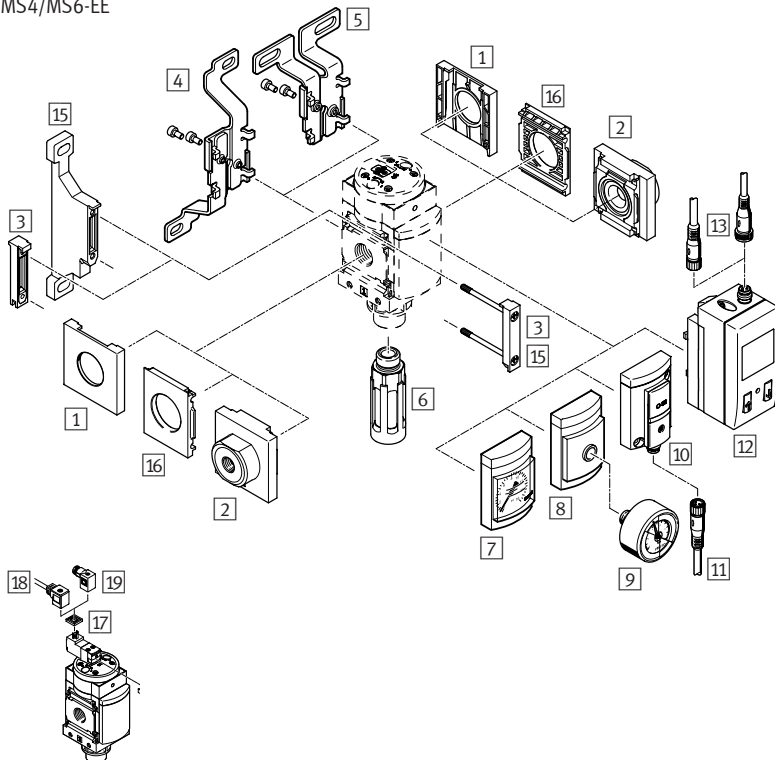

- 15 Mounting bracket MS4/6-WP
→ [ms4-wp](#)
- 16 Mounting plate MS4/6-AEND
→ [ms4-aend](#)
- 17 Illuminating seal MEB-LD
→ [ms4-e](#)
- 18 Plug socket with cable KMEB
→ [ms4-e](#)
- 19 Plug socket MSSD-EB → [ms4-e](#)

Mounting bracket
MS4/MS6-WP, MS4/MS6-WPB,
MS4/MS6-WPM → 259
MS4/6-WPE → [ms4-wpe](#)

On/off and soft-start valves > MS series >

Soft-start/quick exhaust valves MS4/MS6-DL, MS6-SV, MS series



MS-DL:

- For slowly pressurising and exhausting pneumatic systems (for use with on/off valves EM1 and EE)

MS-SV-C:

- For the gradual pressurisation and quick exhausting of system components (single channel)

- Connection G1/4, G1/2
- Flow rate 1000 ... 6450 l/min
- Operating pressure 3 ... 18 bar
- Selected types in accordance with ATEX directive for potentially explosive atmospheres

→ www.festo.com/ex

Order code – Basic design

001	002	003	004	005	006	007
MS						

Legend: Mandatory entry Optional entry

001	Type
MS	Standard service unit
002	Size
4	Grid dimension 40 mm
6	Grid dimension 62 mm
003	Service function
DL	Pneumatically actuated soft-start valve
SV	Soft-start/quick exhaust valve
004	Pneumatic connection
1/4	Female thread G1/4
1/2	Female thread G1/2

005	Performance Level
-	Without
C	Category 1, to EN ISO 13849-1
006	Supply voltage
-	Without (pneumatically actuated soft-start valve)
10V24	Supply voltage 24 V DC
007	Silencer
-	Without silencer
S	With silencer

Product options

- Additional connection sizes
- Connecting plates
- Supply voltage
- Pressure gauge/pressure gauge alternatives
- Alternative pressure gauge scale
- Type of mounting
- Tamper protection
- EU certification
- UL certification
- Direction of flow

Configurable product

This product and all its product options can be ordered online via the configurator:

→ www.festo.com/catalogue/ms4-dl

→ www.festo.com/catalogue/ms6-sv

Ordering – Basic design

002 Size	004 Pneumatic connection	Type	Part no.
003 Pneumatically actuated soft-start valve			
4	G1/4	MS4-DL-1/4	529531
6	G1/2	MS6-DL-1/2	529817
003 Soft-start/quick exhaust valve			
6	G1/2	MS6-SV-1/2-C-10V24-S	8001469

Accessories

MS4/MS6-DL

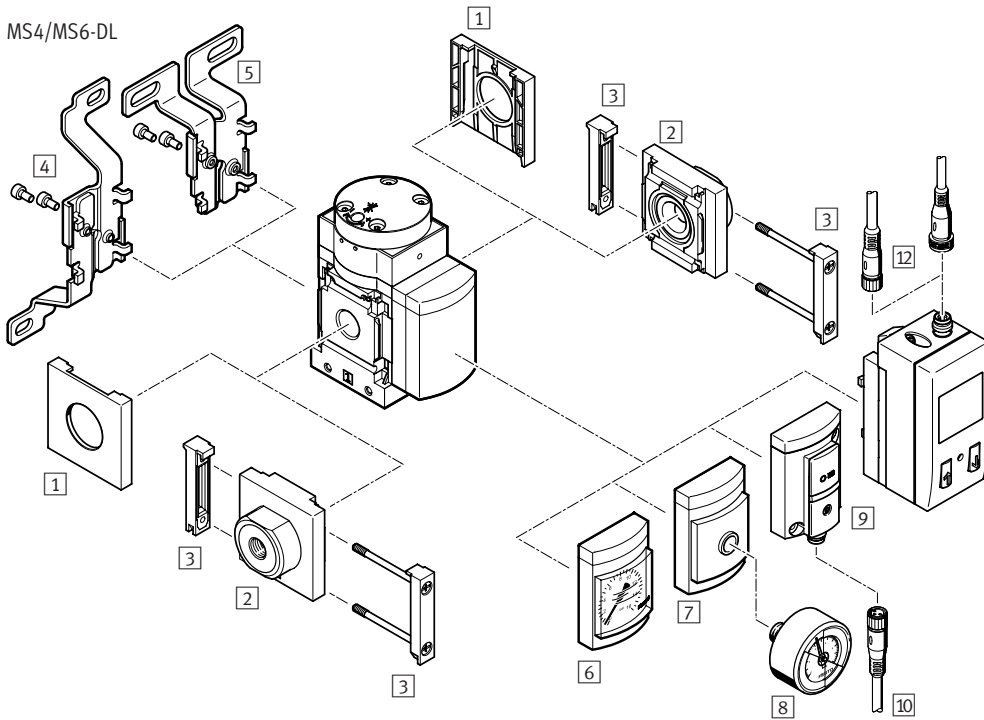

- 1 Cover cap MS-END → [ms4-end](#)
- 2 Connecting plate kit MS4/6-AG... → 271
- 3 Module connector MS-MV → 259
- 4 Mounting bracket MS-WB → 259
- 5 Mounting bracket MS-WBM → [ms4-wbm](#)
- 6 MS pressure gauge → [ms4-dl](#)
- 7 Adapter plate for EN pressure gauge → [ms4-dl](#)
- 8 Pressure gauge MA → [ms4-dl](#)
- 9 Pressure sensor without display → [ms4-dl](#)
- 10 Connecting cable NEBU-M8...-LE3 → 279
- 11 Pressure sensor with display → [ms4-dl](#)
- 12 Connecting cable NEBU-M8...-LE3/NEBU-M12...-LE4 → 279

Mounting bracket
MS4/MS6-WP, MS4/MS6-WPB,
MS4/MS6-WPM → 259
MS4/6-WPE → [ms4-wpe](#)

MS6-SV

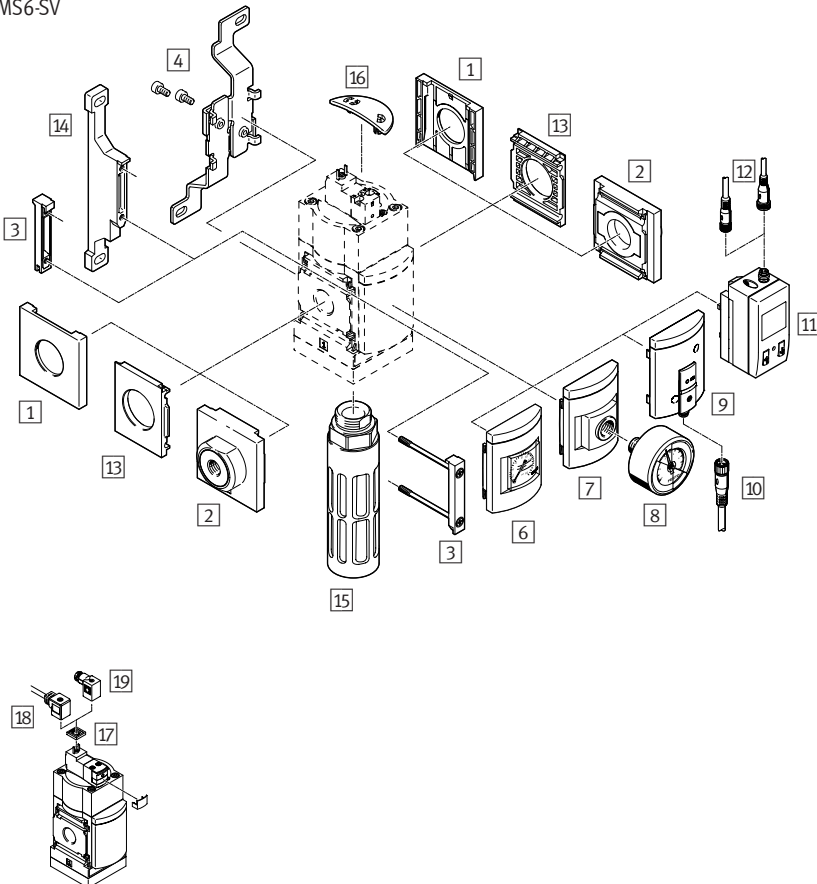

- 13 Mounting plate MS6-AEND → [ms6-aend](#)
- 14 Mounting bracket MS-WP → 259
Mounting bracket MS-WPB → 259
- 15 Silencer U-3/4-B → [ms6-sv](#)
- 16 Cover MS6-SV-C-MK → [ms6-sv](#)
- 17 Illuminating seal MEB-LD → [ms6-sv](#)
- 18 Plug socket with cable KMEB → [ms6-sv](#)
- 19 Plug socket MSSD-EB → [ms6-sv](#)

Mounting bracket
MS4/MS6-WPM → 259
MS4/6-WPE → [ms4-wpe](#)

Compressed air distributors > MS series >

Branching modules MS4/MS6-FRM, MS series



- Can be used as an intermediate distributor for varying air qualities
- Outlet at top and bottom
- Flow rate 1200 ... 14700 l/min
- Operating pressure 0 ... 20 bar

Order code – Basic design

001 002 003 004 005
 MS - FRM - -

Legend: Mandatory entry Optional entry

001	Series
MS	Standard service unit
002	Size
4	Grid dimension 40 mm
6	Grid dimension 62 mm
003	Service function
FRM	Branching module

004	Pneumatic connection
1/4	Female thread G1/4
1/2	Female thread G1/2
005	Non-return function/pressure switch
-	Standard

Product options

- Additional connection sizes
- Connecting plates
- Pressure gauge/pressure gauge alternatives
- Alternative pressure gauge scale
- Pressure switch
- Type of mounting
- EU certification
- UL certification
- Flow direction

Configurable product

This product and all its product options can be ordered online via the configurator:

→ www.festo.com/catalogue/...

Enter the part number or the type.

Part no.	Type	Standard nominal flow rate	Operating pressure
527703	MS4-FRM	1200 ... 4600 l/min	0 ... 14 bar
527676	MS6-FRM	3200 ... 14700 l/min	0 ... 20 bar

Ordering – Basic design

002 Size	004 Pneumatic connection	Type	Part no.
6	G1/4	MS6-FRM-1/4	529857
6	G1/2	MS6-FRM-1/2	529853

Accessories

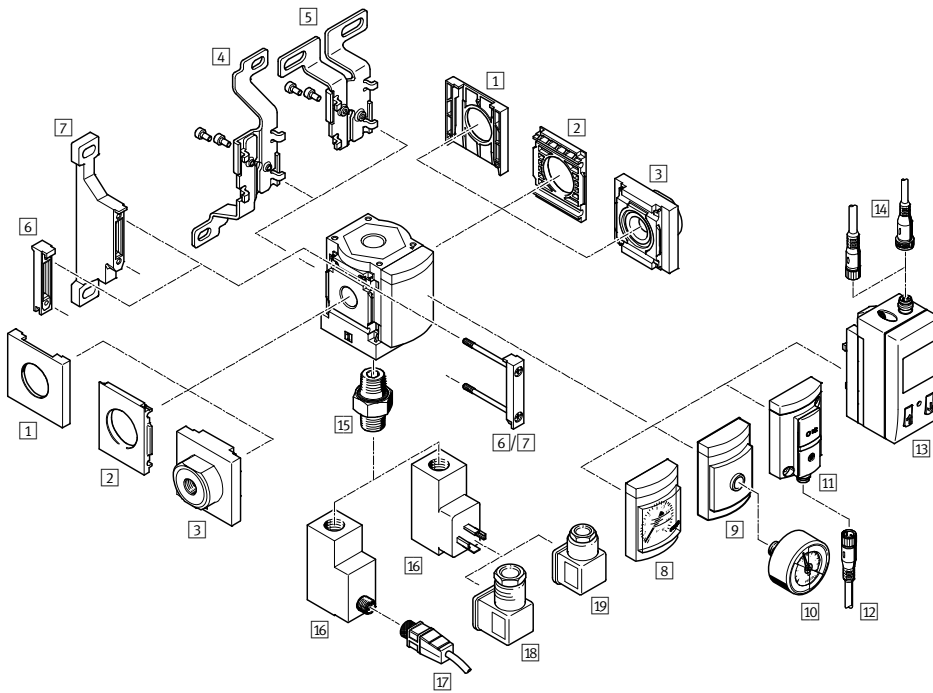

- 1 Cover cap MS4-END → [ms4-end](#)
- 2 Mounting plate MS4/6-AEND → [ms4-aend](#)
- 3 Connecting plate kit MS4/6-AG... → 271
- 4 Mounting bracket MS-WB → 259
- 5 Mounting bracket MS4-WBM → [ms4-wbm](#)
- 6 Module connector MS-MV → 259
- 7 Mounting bracket MS-WP → 259
- 8 MS pressure gauge → [ms-frm](#)
- 9 Adapter plate for EN pressure gauge → [ms-frm](#)
- 10 Pressure gauge MA → [ma](#)
- 11 Pressure sensor without display → [ms-frm](#)
- 12 Connecting cable NEBU-M8...-LE3 → 279
- 13 Pressure sensor with display → [ms-frm](#)
- 14 Connecting cable NEBU-M8...-LE3/NEBU-M12...-LE4 → 279
- 15 Double nipple ESK → [ms-frm](#)
- 16 Pressure switch PEV → [ms-frm](#)
- 17 Connecting cable NEBU-M12...-LE4 → 279
- 18 Angled socket PEV-1/4-WD-LED → [ms-frm](#)
- 19 Plug socket MSSD-C-4P → [ms-frm](#)

Compressed air distributors > MS series >

Distributor blocks MS4/MS6-FRM-FRZ, MS series



- Can be used as an intermediate distributor for varying air qualities
- Outlet at top and bottom
- Flow rate 2900 ... 14600 l/min
- Operating pressure 0 ... 20 bar

Order code

001 002 003

MS -FRM- FRZ

Legend: Mandatory entry

001	Series
MS	Standard service unit
002	Size
4	Grid dimension 40 mm
6	Grid dimension 62 mm
003	Service function
FRM-FRZ	Distributor block

Ordering

002 Size	Pneumatic connection 3, 4	Type	Part no.
4	G1/4	MS4-FRM-FRZ	549336
6	G1/2	MS6-FRM-FRZ	549337

Accessories for compressed air preparation >
Connecting plate kit MS4/MS6-AG...



- Adapter for pneumatic connection
- MS6-AGE for implementing threaded connection G3/4

Ordering

Size	Pneumatic connection	Type	Part no.
4	G1/4	MS4-AGB	526069
4	G3/8	MS4-AGC	526070
6	G1/2	MS6-AGD	526082
6	G3/4	MS6-AGE	526083

10

Electrical connection technology



Highlights

Contents



Connecting cables

NEBU

- + The modular cable system with unlimited combination options of plugs, plug sockets, cable lengths and qualities
- + Adapted to all devices with M8 and M12 plugs
- + Cable length 0.1 ... 30 m

→ 279

Product overview	274
Overview: Connecting cable NEBU, universal	278
Connecting cables NEBU, universal	279
Connecting cables NEBM	280

Product overview

Software-Tools

Configurator		<p>Design a product with numerous features reliably and quickly with the help of the configurator.</p> <p>Select all the required product features step by step. The use of logic checks ensures that only correct configurations are available for selection.</p> <p>A dynamic graphic generated on the basis of the configuration provides a visual aid for selecting the correct product features.</p> <p>The configurator is part of the electronic catalogue and is not available as a separate software program.</p>
---------------------	---	--

Connecting cables >

Universal connecting cables

	 <p>Connecting cables NEBU</p>
Electrical connection, connection type	Socket, cable, plug
Electrical connection, cable outlet	Straight, angled, can be adjusted in 15° steps
Electrical connection, design	Round
Electrical connection, connection technology	G7/8 coded to NFPA/T3.5.29 R1-2007, M12x1 A-coded to EN 61076-2-101, M8x1 A-coded to EN 61076-2-104, open end
Electrical connection, number of pins/wires	3, 4, 5, 8
Cable length	0.1 ... 30 m
Description	<ul style="list-style-type: none"> • Designs for static, standard, energy chain and robot applications • Designs with switching status indication • Designs for connecting sensors and actuators
→ Page/online	279

Connecting cables >

Connecting cables for control systems

	 <p>Connecting cables NEBC</p>
Electrical connection	25-pin, 5-pin, straight plug, straight plug/open end, Sub-D/-, Sub-D/ Sub-D, square design/angled, M12x1
Electrical connection, connection type	Socket, plug, hybrid plug, plug and socket strip, cable
Electrical connection, cable outlet	Straight, angled
Electrical connection, design	Square, round
Electrical connection, connection technology	M12x1 Festo-specific coding, M12x1 A-coded to EN 61076-2-101, M8x1, D-coded to EN 61076-2-114, M9x0.5, USB 3.0 type A, open end, M8x1 A-coded to EN 61076-2-104, RJ45, RJ45 and socket strip 12 pins, 2 rows, Sub-D, USB 3.0 type B micro
Electrical connection, number of pins/wires	4, 5, 8, 9, 10, 15, 17, 20
Cable length	0.2 ... 30 m
Description	<ul style="list-style-type: none"> • Variants with an easy-to-clean design • Standard variants, variants with shielding or as a hybrid cable • Variant suitable for use with energy chains • Variants with Ethernet, CANopen, I-Port or RS232
→ Page/online	nebc

Connecting cables >



Connecting cables for motors

	 <p>Motor, encoder, resolver cables NEBM</p>
Electrical connection, connection type	Socket, hybrid socket, cable, plug, plug and cable
Electrical connection, cable outlet	Straight, angled
Electrical connection, design	Square, round
Electrical connection, connection technology	Connection pattern F1, connection pattern H6, coded for motor, connection pattern H7, coded for motor brake, connection pattern L4, connection pattern L5, connection pattern RE, ITT M3, M12x1 A-coded to EN 61076-2-101, RJ45, RJ45 and open end, Sub-D, M16x0.75, M23x1, open end, M40x1.5
Electrical connection, number of pins/wires	2, 4, 6, 8, 9, 10, 12, 14, 15, 18, 28, 31
Cable length	0.5 ... 100 m
Description	<ul style="list-style-type: none"> • For servo motors EMMB-AS, EMME-AS, EMMS-AS, EMMT-AS and stepper motor EMMS-ST • Can be used in a wide temperature range • For motor controller CMMS-ST, CMMO-ST, CMMP-AS • Suitable for use with energy chains
→ Page/online	280

Product overview

Connecting cables >

Connecting cables for valves

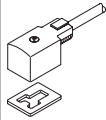
	 Connecting cables NEBV	 Plug sockets with cable KMEB-1, KMEB-2, KMEB-3	 Plug sockets with cable KMF
Electrical connection	4-pin/2-wire, 4-pin/3-pin, 44-pin, socket, angled socket/cable, angled socket/straight plug, M8x1/M8x1, Sub-D, M8x1	Angled socket, to DIN EN 175301-803, type C, 2-pin, 3-pin, 4-pin, 5-pin	Socket
Electrical connection, connection type	2x single wire, socket, socket, slim, cable, plug, twin cable		
Electrical connection, cable outlet	Straight, angled		
Electrical connection, design	Square, round		
Electrical connection, connection technology	Connection pattern ZB, self-tapping screw, connection pattern ZC, self-tapping screw, connection pattern ZC, metric screw, connection pattern H, connection pattern S, M12x1 A-coded to EN 61076-2-101, connection pattern type A based on EN 175301-803, connection pattern type B to industry standard 11 mm, connection pattern type C to EN 175301-803, M8x1 A-coded to EN 61076-2-104, open end, Sub-D		
Electrical connection, number of pins/wires	2, 3, 4, 5, 8, 10, 25, 26, 27, 36, 37, 44		
Cable length	0.2 ... 30 m	0.5 ... 10 m	2.5 ... 10 m
Description	<ul style="list-style-type: none"> • Pre-assembled at one or both ends 	<ul style="list-style-type: none"> • For valves with EB solenoid coil • With PVC or PU cable • Mounting via central screw 	<ul style="list-style-type: none"> • For valves with F solenoid coil • Mounting via central screw • Polyvinyl chloride cable • Ambient temperature -20 ... +80 °C
→ Page/online	nebv	kmeb-1	kmf



Plug connectors >

Universal plug connectors

	 Distributors NEDY
Electrical connection, connection type	2x socket, 2x cable, cable, plug
Electrical connection, design	Square, round
Electrical connection, connection technology	Connection pattern ZB, self-tapping screw, connection pattern ZC, self-tapping screw, connection pattern ZC, metric screw, connection pattern H, connection pattern type A to EN 175301-803, connection pattern type B to EN 175301-803, connection pattern type B to industry standard 11 mm, connection pattern type C to EN 175301-803, connection pattern type C to industry standard 9.4 mm, M8x1 A-coded to EN 61076-2-104, M12x1 A-coded to EN 61076-2-101, open end
Electrical connection, number of pins/wires	2, 3, 4, 5
Degree of protection	IP65, IP67, IP68, IP69K
Description	<ul style="list-style-type: none"> • Collecting signals between field devices (sensors) and controller inputs with double assignment • Distributing signals between controller outputs with double assignment and field devices (actuators, e.g. valves)
→ Page/online	nedy

Plug connectors >

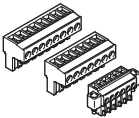
Plug connectors for control systems

	 <p>Plug assortments NEKM</p>	 <p>Plug, adapter, manifold block NEFC</p>
Electrical connection, connection technology	Screw connector	M12x1 A-coded to EN 61076-2-101
Electrical connection, number of pins/wires	2 ... 9	5, 8
Description	<ul style="list-style-type: none"> For motor controller CMMS-ST, CMMO-ST, CMMP-AS For servo drive CMMT-AS 	<ul style="list-style-type: none"> Adapter, 5-pin M12, for mini USB socket with controller software for CPX terminal Adapter for rotary drive unit ERMS as connection between motor and IO-Link® master Plug and manifold block for motor controller CMMO-ST as connection from I/O interface to the controller
→ Page/online	nekm	nefc

Plug connectors >

Plug connectors for valves

	 <p>Plug sockets MSSD</p>
Electrical connection	Socket, angled socket, square design, 3-pin, type C, socket, to EN 175301-803, type C, square design, square design MSC, square design MSEB, square design MSF, square design MSN1, square design MSN2, square design MSV, to DIN EN 175301-803, to DIN EN 61984, type A, type B, type C, 3-pin, 4-pin
Electrical connection, connection type	Socket
Electrical connection, design	Square
Electrical connection, connection technology	Connection pattern type A to EN 175301-803, connection pattern type B to industry standard 11 mm, screw terminal
Electrical connection, number of pins/wires	3
Connection cross section	0.25 ... 1.5 mm ²
Degree of protection	IP50, IP65, IP67, to IEC 60529
Description	<ul style="list-style-type: none"> For valves with F, D, N1, V, E, EB, N2, Y, Z, ZB, ZC, MD-2 and MH-2 solenoid coils For connecting individual valves Optionally with LED display
→ Page/online	mssd

Overview: Connecting cable NEBU, universal

The configurable connecting cables offer unlimited combinations in terms of plug sockets, cable lengths, cable qualities and plugs. They match all devices with M8 and M12 plugs such as proximity sensors, position transmitters, pressure and flow sensors, optical and inductive sensors as well as individual valves. Cable

lengths are freely selectable within a range of 0.1 ... 30 m.

The ends and middle pieces can also be freely selected for maximum customisation.

Basic

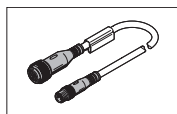
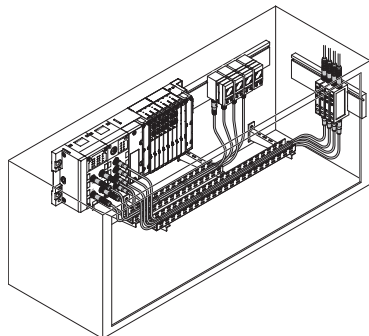

Applications

Static installation, no or small mechanical load

Properties of basic cables

Price-optimised cable for simple, mainly static applications

Standard

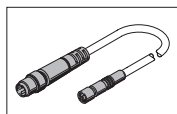
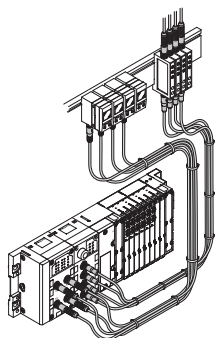

Applications

Low to average mechanical load, energy chains with large radius ≥ 75 mm

Properties of standard cables

Good oil resistance, good bending properties, suitable for use with energy chains

Energy chain

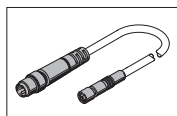
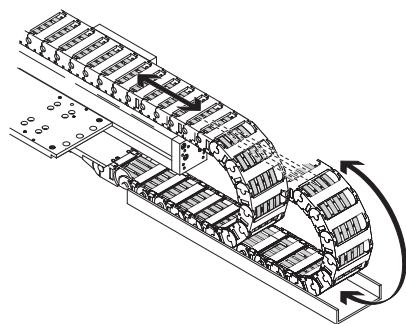

Applications

Energy chain applications involve high mechanical loads, particularly if very small radii are required.

Properties of cables suitable for use with energy chains

Very good oil resistance, very good bending properties, highly suitable for energy chains, halogen-free

Robot

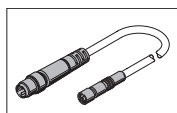
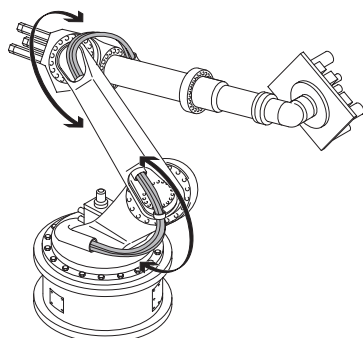

Applications

Robot applications involve high mechanical loads that are primarily caused by torsion.

Properties of robot cables

Very good oil resistance, very good bending properties, suitable for use with energy chains, halogen-free

The technical data as well as an overview of the range of options for the connecting cables NEBU can be found online

→ www.festo.com/catalogue/nebu



- Plug socket with cable for connecting inputs/outputs
- Pre-assembled at both ends

Order code – Basic design

001 002 003 004 005 006 007 008 009
 NEBU - [] [] - [] - K - [] - [] - [] []

Legend: [] Mandatory entry [] Optional entry

001	Type
NEBU	Connecting cable, universal
002	Connection technology, left
M8	Socket with connecting thread M8
M12	Socket with connecting thread M12
003	Connection technology version, left
G3	Straight, 3-pin
G5	Straight, 5-pin
W3	Angled, 3-pin
004	Display
-	Without LED
005	Cable characteristic
K	Standard

006	Cable length
0,5	0.5 m
1	1 m
2,5	2.5 m
5	5 m
10	10 m
007	Cable designation
-	With inscription label holder
008	Connection technology, right
M8	Plug with connecting thread M8
LE	Open cable end
009	Connection technology version, right
3	Open cable end, 3-wire
4	Open cable end, 4-wire
G3	Straight, 3-pin

Product options

Connection technology version
 • Rotatable

Cable characteristics
 • Suitable for use with energy chains

• Suitable for robot applications

• With LED display

Configurable product

This product and all its product options can be ordered online via the configurator:
www.festo.com/catalogue/nebu

Ordering – Basic design

Connecting cables, M8, 3-pin			
Cable length	Connection on right	Type	Part no.
Connection, left: socket M8, straight, 3-pin			
0.5 m	Plug M8, straight, 3-pin	NEBU-M8G3-K-0.5-M8G3	541346
1 m		NEBU-M8G3-K-1-M8G3	541347
2.5 m		NEBU-M8G3-K-2.5-M8G3	541348
5 m		NEBU-M8G3-K-5-M8G3	541349
2.5 m	Open cable end, 3-wire	NEBU-M8G3-K-2.5-LE3	541333
5 m		NEBU-M8G3-K-5-LE3	541334
10 m		NEBU-M8G3-K-10-LE3	541332
Connection, left: socket M8, angled, 3-pin			
2.5 m	Open cable end, 3-wire	NEBU-M8W3-K-2.5-LE3	541338
5 m		NEBU-M8W3-K-5-LE3	541341
10 m		NEBU-M8W3-K-10-LE3	541335

Connecting cables, M12, 5-pin			
Cable length	Connection on right	Type	Part no.
Connection, left: socket M12, straight, 5-pin			
2.5 m	Open cable end, 3-wire	NEBU-M12G5-K-2.5-LE3	541363
5 m		NEBU-M12G5-K-5-LE3	541364
2.5 m	Open cable end, 4-wire	NEBU-M12G5-K-2.5-LE4	550326
5 m		NEBU-M12G5-K-5-LE4	541328
2.5 m		Open cable end, 5-wire	NEBU-M12G5-K-2.5-LE5
5 m		NEBU-M12G5-K-5-LE5	541331

Connecting cables > Connecting cables for motors >

Connecting cables NEBM



NEBM-M16G8-E-...-Q7-LE8



NEBM-M23G15-EH-...-Q9N-R3LEG14

- For servo motor EMMT-AS and stepper motor EMMS-ST
- Suitable for use with energy chains

Order code – Basic design

001 002 003 004 005 006 007 008 009 010

NEBM - [] [] [] - [] - [] - [] [] [] - [] [] []

Legend: Mandatory entry Optional entry

001	Type
NEBM	Connecting cables for motors
002	Connection technology, left
M12	M12, A-coded
M16	M16
M23	M23
S1	Sub-D
003	Plug socket
G	Straight
W	Angled
004	Number of pins/wires, left
8	8-pin
9	9-pin
15	15-pin
005	Cable characteristic/version
E	Suitable for energy chains/standard
EH	Suitable for energy chains/hybrid cables
006	Cable length [m]
...	1,5, 2,5, 5, 7, 7,5, 10, 15, 20

007	Wire cross section
-	Standard
Q5	0.34 mm ²
Q7	0.75 mm ²
Q9	1.5 mm ²
008	Cable designation
-	Without inscription label holder
N	Without inscription label holder
009	Connection technology, right
LE	Open end
S1G	Sub-D, straight
R3LEG	RJ45 and open end, straight plug and cable outlet
010	Number of pins/wires, right
6	6-pin
8	8-pin
9	9-pin
14	14-pin
15	15-pin

Product options

Connection technologies

- M40, ITT M3, connection pattern L4, connection pattern L5

Cable lengths

- 0.5 ... 100 m

Cable characteristics

- Suitable for robot applications

Number of pins/wires

- 2, 4, 6, 12, 18

Configurable product

This product and all its product options can be ordered online via the configurator:

→ www.festo.com/catalogue/nebm

Ordering – Basic design

Encoder cable for stepper motors EMMS-ST, motor controller CMMS-ST

Cable length	Type	Part no.
Straight plug, min. bending radius: 51 mm, ambient temperature: -40 ... +70 °C		
5 m	NEBM-M12G8-E-5-S1G9	550748
10 m	NEBM-M12G8-E-10-S1G9	550749
15 m	NEBM-M12G8-E-15-S1G9	550750

Motor cable for stepper motors EMMS-ST-28, motor controller CMMO-ST

Cable length	Type	Part no.
Straight plug, min. bending radius: 62 mm, ambient temperature: -40 ... +80 °C		
1.5 m	NEBM-M12G8-E-1.5-Q5-LE6	1449600
2.5 m	NEBM-M12G8-E-2.5-Q5-LE6	1449601
5 m	NEBM-M12G8-E-5-Q5-LE6	1449602
7 m	NEBM-M12G8-E-7-Q5-LE6	1449603
10 m	NEBM-M12G8-E-10-Q5-LE6	1449604

Motor cable for stepper motors EMMS-ST-42/57, motor controller CMMO-ST, CMMS-ST

Cable length	Type	Part no.
Straight plug, min. bending radius: 62 mm, ambient temperature: -40 ... +80 °C		
1.5 m	NEBM-S1G9-E-1.5-Q5-LE6	1450368
2.5 m	NEBM-S1G9-E-2.5-Q5-LE6	1450369
5 m	NEBM-S1G9-E-5-Q5-LE6	1450370
7 m	NEBM-S1G9-E-7-Q5-LE6	1450371
10 m	NEBM-S1G9-E-10-Q5-LE6	1450372
Angled plug, min. bending radius: 62 mm, ambient temperature: -40 ... +80 °C		
1.5 m	NEBM-S1W9-E-1.5-Q5-LE6	1450736
2.5 m	NEBM-S1W9-E-2.5-Q5-LE6	1450737
5 m	NEBM-S1W9-E-5-Q5-LE6	1450738
7 m	NEBM-S1W9-E-7-Q5-LE6	1450739
10 m	NEBM-S1W9-E-10-Q5-LE6	1450740

Motor cable for stepper motors EMMS-ST-87, motor controller CMMO-ST, CMMS-ST

Cable length	Type	Part no.
Straight plug, min. bending radius: 80 mm, ambient temperature: -40 ... +80 °C		
1.5 m	NEBM-S1G15-E-1.5-Q7-LE6	1450834
2.5 m	NEBM-S1G15-E-2.5-Q7-LE6	1450835
5 m	NEBM-S1G15-E-5-Q7-LE6	1450836
7 m	NEBM-S1G15-E-7-Q7-LE6	1450837
10 m	NEBM-S1G15-E-10-Q7-LE6	1450838
Angled plug, min. bending radius: 80 mm, ambient temperature: -40 ... +80 °C		
1.5 m	NEBM-S1W15-E-1.5-Q7-LE6	1450943
2.5 m	NEBM-S1W15-E-2.5-Q7-LE6	1450944
5 m	NEBM-S1W15-E-5-Q7-LE6	1450945
7 m	NEBM-S1W15-E-7-Q7-LE6	1450946
10 m	NEBM-S1W15-E-10-Q7-LE6	1450947

Encoder cable for stepper motors EMMS-ST, motor controller CMMO-ST

Cable length	Type	Part no.
Straight plug, min. bending radius: 68 mm, ambient temperature: -40 ... +80 °C		
1.5 m	NEBM-M12G8-E-1.5-LE8	1451586
2.5 m	NEBM-M12G8-E-2.5-LE8	1451587
5 m	NEBM-M12G8-E-5-LE8	1451588
7 m	NEBM-M12G8-E-7-LE8	1451589
10 m	NEBM-M12G8-E-10-LE8	1451590
Angled plug, min. bending radius: 68 mm, ambient temperature: -40 ... +80 °C		
1.5 m	NEBM-M12W8-E-1.5-LE8	1451674
2.5 m	NEBM-M12W8-E-2.5-LE8	1451675
5 m	NEBM-M12W8-E-5-LE8	1451676
7 m	NEBM-M12W8-E-7-LE8	1451677
10 m	NEBM-M12W8-E-10-LE8	1451678

Motor cable for servo motor EMME-AS

Cable length	Type	Part no.
Straight plug (cable cross section: 0.75 mm ²)		
2.5 m	NEBM-M16G8-E-2.5-Q7-LE8	8004662
5 m	NEBM-M16G8-E-5-Q7-LE8	8003770
7 m	NEBM-M16G8-E-7.5-Q7-LE8	8004663
10 m	NEBM-M16G8-E-10-Q7-LE8	8003771
15 m	NEBM-M16G8-E-15-Q7-LE8	8003772
Straight plug (cable cross section: 0.15 mm ²)		
2.5 m	NEBM-M16G8-E-2.5-Q9-LE8	8004660
5 m	NEBM-M16G8-E-5-Q9-LE8	8003766
7 m	NEBM-M16G8-E-7.5-Q9-LE8	8004661
10 m	NEBM-M16G8-E-10-Q9-LE8	8003767
15 m	NEBM-M16G8-E-15-Q9-LE8	8003768

Encoder cable for servo motor EMME-AS

Cable length	Type	Part no.
Straight plug		
2.5 m	NEBM-M12G8-E-2.5-N-S1G15	8004664
5 m	NEBM-M12G8-E-5-N-S1G15	8003762
7 m	NEBM-M12G8-E-7.5-N-S1G15	8004665
10 m	NEBM-M12G8-E-10-N-S1G15	8003763
15 m	NEBM-M12G8-E-15-N-S1G15	8003764

Motor cable for servo motors EMMT-AS, hybrid cable

Cable length	Type	Part no.
Straight plug and cable outlet		
2.5 m	NEBM-M23G15-EH-2.5-Q9N-R3LEG14	5251381
5 m	NEBM-M23G15-EH-5-Q9N-R3LEG14	5251382
7 m	NEBM-M23G15-EH-7.5-Q9N-R3LEG14	5251383
10 m	NEBM-M23G15-EH-10-Q9N-R3LEG14	5251384
15 m	NEBM-M23G15-EH-15-Q9N-R3LEG14	5251385
20 m	NEBM-M23G15-EH-20-Q9N-R3LEG14	5251386
X length ¹⁾	NEBM-M23G15-EH-...-Q9N-R3LEG14	5251380

1) Choice of cable lengths: 0.5 ... 99.9 m, in increments of 0.1 m.

Servo motors EMMT-AS → 118
Stepper motors EMMS-ST → 121

Motor controllers CMMS-ST → 124

11

Pneumatic connection technology

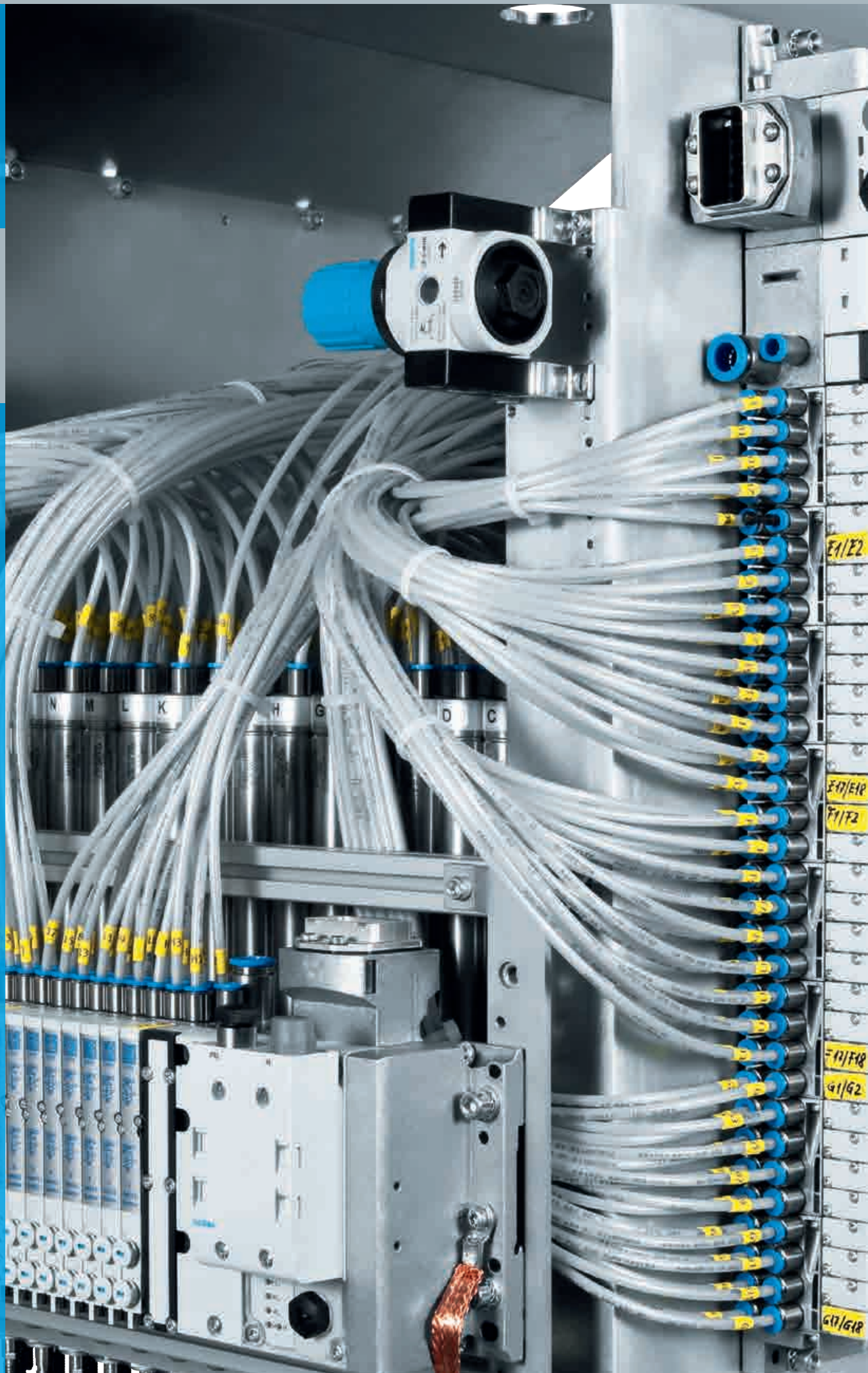

Highlights



Plastic tubing

PUN-H

- + Wide choice of variants
- + PUN-H: high resistance to microbes and hydrolysis and approved for use in the food industry
- + PUN-H-T: translucent black, blue, green, red, yellow

→ 288



Push-in fittings

QSM, QS

- + QSM: mini series for maximum component density in small installation spaces
- + QS: standard series for maximum flexibility in standard applications



→ 291, 293

Contents

Product overview	284
Overview: Tubing/fitting combinations	287
Plastic tubing PUN-H, hydrolysis-resistant	288
Push-in fittings/connectors QSM, mini series	291
Push-in fittings/connectors QS, standard series	293
Push-in fittings/connectors NPQH	298
Threaded fittings NPFC	302
Blanking plugs B-...	305
Quick coupling sockets/plugs NPHS, KD/KS	306



Product overview

Software-Tools

<p>Product Finder for tubing</p>		<p>Simply enter parameters such as working pressure, chemicals and required resistance to cleaning agents and have the program calculate the right tubing for your application.</p> <p>This tool can be found</p> <ul style="list-style-type: none"> on our website at www.festo.com/catalogue by clicking on the blue button "Product Finder".
<p>Festo Design Tool 3D</p>		<p>The Festo Design Tool 3D is a 3D product configurator for generating specific CAD product combinations from Festo.</p> <p>The configurator makes your search for the right accessory easier, more reliable and faster.</p> <p>You can then order the module that has been created as a single order item, either completely pre-assembled or as individual parts in a single box.</p> <p>This considerably reduces your bill of materials, and downstream processes such as product ordering, order picking and assembly are significantly simplified.</p> <p>All ordering options are available in the following countries: AT, BE, CH, CZ, DE, DK, ES, EST, FI, FR, GB, GR, HU, IE, IT, NL, NO, PL, PT, RU, SE, SI, SK, TR, ZA.</p> <p>This tool can be found</p> <ul style="list-style-type: none"> via the address: www.festo.com/fdt-3d-online in the countries listed above.

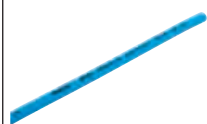

Tubing >

O.D. tubing

	 Plastic tubing PUN-H, PUN-H-DUO	 Plastic tubing PUN, PUN-DUO	 Plastic tubing PTFEN
O.D.	2 ... 16 mm	3 ... 16 mm	4 ... 16 mm
I.D.	1.2 ... 11 mm	2 ... 11 mm	2.9 ... 11 mm
Temperature-dependent operating pressure	-0.95 ... 10 bar	-0.95 ... 30 bar	-0.95 ... 15 bar
Ambient temperature	-35 ... 60°C	-35 ... 60°C	-20 ... 150°C
Description	<ul style="list-style-type: none"> • Polyurethane • High resistance to microbes and hydrolysis • Food-safe, see www.festo.com/sp/pun-h > "Certificates" tab • Suitable for energy chains • Also available as DUO tubing • Operating media: compressed air, vacuum, water 	<ul style="list-style-type: none"> • Polyurethane • High resistance to stress cracks • Suitable for energy chains • Also available as DUO tubing • Operating media: compressed air, vacuum 	<ul style="list-style-type: none"> • Polytetrafluoroethylene • Food-safe, see www.festo.com/sp/ptfen -> "Certificates" tab • High resistance to chemicals • High temperature resistance • Operating media: compressed air, vacuum
→ Page/online	288	pun	ptfen





Tubing >

Standard O.D. tubing

		
	Plastic tubing PEN	Plastic tubing PLN
O.D.	4 ... 16 mm	4 ... 16 mm
I.D.	2.7 ... 10.8 mm	2.9 ... 12 mm
Temperature-dependent operating pressure	-0.95 ... 10 bar	-0.95 ... 14 bar
Ambient temperature	-30 ... 60°C	-30 ... 80°C
Description	<ul style="list-style-type: none"> • Polyethylene • High resistance to chemicals and very high resistance to hydrolysis • Resistant to most cleaning agents and lubricants • Suitable for energy chains • Operating media: compressed air, vacuum, water 	<ul style="list-style-type: none"> • Polyethylene • High resistance to chemicals, microbes and hydrolysis • Food-safe, see www.festo.com/sp/pln > "Certificates" tab • Resistant to most cleaning agents and lubricants • Operating media: compressed air, vacuum, water
→ Page/online	pen	pln

Fittings >



Push-in fittings

				
	Push-in fittings/connectors, mini series QSM, QSMC, QSMF, QSML, QSMP, QSMS, QSMT, QSMX, QSMY	Push-in fittings/connectors, standard series QS, QSF, QSS, QSC, QSH, QSL, QST, QSW, QSX, QSY	Push-in fittings/connectors NPQH	Push-in fittings/connectors, metal, standard series NPQM
Pneumatic connection 1	Male thread M8x1.25, male thread G1/8, M3, M5, M6, M6x0.75, M7, M8x0.75, R1/8, female thread M3, M5, push-in sleeve QS-2, QS-3, QS-4, QS-6, for tubing O.D. 2 mm, 3 mm, 4 mm, 6 mm	Male thread G1/2, G1/4, G1/8, G3/4, G3/8, M5, R1/2, R1/4, R1/8, R3/8, female thread G1/2, G1/4, G1/8, G3/8, push-in sleeve QS-10, QS-12, QS-16, QS-4, QS-6, QS-8, for tubing O.D. 10 mm, 12 mm, 16 mm, 4 mm, 6 mm, 8 mm	Male thread G1/2, G1/4, G1/8, G3/8, M5, M7, female thread G1/4, G1/8, push-in sleeve QS-10, QS-12, QS-14, QS-4, QS-6, QS-8, for tubing O.D. 10 mm, 12 mm, 14 mm, 4 mm, 6 mm, 8 mm	Push-in sleeve QS-10, QS-12, QS-14, QS-4, QS-6, QS-8, for tubing O.D. 10 mm, 12 mm, 14 mm, 4 mm, 6 mm, 8 mm, G1/2, G1/4, G1/8, G3/8, M5, M7
Pneumatic connection 2	For tubing O.D. 2 mm, 3 mm, 4 mm, 6 mm	Female thread G1/2, G1/4, G1/8, G3/8, push-in sleeve QS-10, QS-12, QS-16, QS-4, QS-6, QS-8, for tubing O.D. 10 mm, 12 mm, 16 mm, 22 mm, 4 mm, 6 mm, 8 mm	Push-in sleeve QS-10, QS-12, QS-14, QS-4, QS-6, QS-8, for tubing O.D. 10 mm, 12 mm, 14 mm, 4 mm, 6 mm, 8 mm	For tubing O.D. 10 mm, 12 mm, 14 mm, 3 mm, 4 mm, 6 mm, 8 mm
Operating pressure for entire temperature range	-0.95 ... 6 bar	-0.95 ... 14 bar	-0.95 ... 20 bar	-0.95 ... 16 bar
Ambient temperature	-10 ... 80°C	-20 ... 80°C	0 ... 150°C	-20 ... 70°C
Description	<ul style="list-style-type: none"> • Mini series • Compact for maximum component density in confined installation spaces • PBT and nickel-plated brass • Operating media: compressed air, vacuum 	<ul style="list-style-type: none"> • Standard series • Wide range of variants: large selection for maximum flexibility in standard applications • PBT and nickel-plated brass • Operating media: compressed air, vacuum, (water) 	<ul style="list-style-type: none"> • Solid-metal brass, chemically nickel-plated • High corrosion and chemical resistance • Highly resistant to temperatures and pressure • Food-safe, see www.festo.com/sp/npqh > "Certificates" tab • Operating media: compressed air, vacuum, water 	<ul style="list-style-type: none"> • Solid-metal brass, nickel-plated • Attractively priced metal push-in fitting • Sturdy • Operating media: compressed air, vacuum
→ Page/online	291	293	298	npqm



Product overview

Fittings >

Threaded fittings

		
	Threaded fittings NPFC	Blanking plug B
Pneumatic connection 1	G1, G1/2, G1/4, G1/8, G3/4, G3/8, M3, M5, M7, R1, R1/2, R1/4, R1/8, R3/4, R3/8	Male thread G1, G1/2, G1/4, G1/8, G3/4, G3/8, M3, M5, M7
Pneumatic connection 2	G1, G1/2, G1/4, G1/8, G3/4, G3/8, M3, M5, R1, R1/2, R1/4, R1/8, R3/4, R3/8	
Operating pressure	-0.95 ... 50 bar	
Ambient temperature	-20 ... 150°C	
Description	<ul style="list-style-type: none"> • Nickel-plated brass • Sleeve • Extension • Double nipple • Reducing nipple • L-, T-, Y- or X-fitting • Operating media: compressed air, vacuum 	<ul style="list-style-type: none"> • Aluminium, stainless steel • With sealing ring
→ Page/online	302	305

Couplings

		
	Quick coupling sockets, quick coupling plugs NPHS-D6, NPHS-S6	Quick coupling sockets, quick coupling plugs KD, KD1, KD2, KD3, KD4, KS, KS1, KS2, KS3, KS4
Pneumatic connection 1	For plug-in nipple I.D. 9 mm, male thread G1/2, G1/4, G1/8, G3/8, female thread G1/2, G1/4, G3/8	N-6, N-9, male thread G1/2, G1/4, G1/8, G3/8, M3, M5, female thread G1/2, G1/4, G1/8, G3/8, M5, CK-3, CK-4, CK-6, CK-9, CN-2
Standard nominal flow rate	875 ... 2083 l/min	44 ... 1350 l/min
Operating pressure	-0.95 ... 20 bar	-0.95 ... 12 bar
Ambient temperature	-20 ... 80°C	-10 ... 80°C
Description	<ul style="list-style-type: none"> • Safety coupling • Shut-off at one end • Exhaust the air on the connector side without releasing the coupling • Combination of coupling and hand slide valve • Can be used as an on/off valve • Nickel-plated brass or galvanised hardened steel 	<ul style="list-style-type: none"> • Quick connection coupling for standard applications without safety function • Shut off at one or both ends • With male or female thread or with barbed fitting or quick connector • Nickel-plated brass, PP • Operating media: compressed air, vacuum
→ Page/online	306	306

Everything from a single source – for the ideal combination

Our range of tubing and fittings covers every conceivable task. Regardless of whether your selection is determined by standard requirements or extreme conditions such as heat, welding spatter, high pH values or resistance to hydrolysis – at Festo you'll always find the right tubing/fitting combination.

Tubing

Material	Polyurethane (PU)					Polyethylene (PE)		Polyamide (PA)				Perfluoroalkoxy alkane		
	Designation	PUN/PUN-DUO → pun	PUN-H ³ /PUN-H-DUO → 288	PUN-CM → pun	PUN-V0 → pun-v0	PUN-V0-C → pun-v0	PEN → pen	PLN → pln	PAN → pan	PAN-R → pan-r	PAN-V0 → pan-v0	PAN-MF → pan-mf	PFAN → pfan	PTFEN → ptfen
Operating medium	Compressed air, vacuum	Compressed air, vacuum, water ¹⁾	Compressed air, vacuum	Compressed air, vacuum, water ¹⁾	Compressed air, vacuum, water ¹⁾	Compressed air, vacuum, water ¹⁾	Compressed air, vacuum, water ¹⁾	Compressed air, vacuum, water ¹⁾	Compressed air, vacuum	Compressed air, vacuum	Compressed air, vacuum, water ¹⁾	Compressed air, vacuum	Compressed air, vacuum, water ¹⁾	Compressed air, vacuum
Temperature [°C]	-35 ... +60	-35 ... +60	-35 ... +60	-35 ... +60	-35 ... +60	-30 ... +60	-30 ... +80	-30 ... +80	-30 ... +80	-30 ... +80	-30 ... +90	-60 ... +100	-20 ... +150	-20 ... +150
Temperature-dependent operating pressure [bar]	-0,95 ... +10	-0,95 ... +10	-0,95 ... +10	-0,95 ... +10	-0,95 ... +10	-0,95 ... +10	-0,95 ... +14	-0,95 ... +19	-0,95 ... +35	-0,95 ... +12	-0,95 ... +31	-0,95 ... +16	-0,95 ... +15	
Resistant to chemicals	-	+	+	+	+	++	++	+	+	+	+	+++	+++	
Food-safe	-	²⁾	-	-	-	-	²⁾	-	-	-	-	²⁾	²⁾	
Hydrolysis-resistant	+	++	++	++	++	+++	+++	++	++	++	++	+++	+++	
Fire tested	UL 94 HB	UL 94 HB	-	UL 94 V0...V2	UL 94 V0...V2	-	-	-	-	UL 94 V0	-	UL 94 V0	UL 94 V0	
Halogen-free	+++	+++	+++	+++	+++	+++	+++	+++	+++	-	+++	-	-	
Flexibility	+++	+++	++	++	++	++	+	++	+	++	+	+	+	
Special features	Wide choice of variants	Hydrolysis-resistant	Anti-static	Flame-retardant	Resistant to welding spatter	Suitable for use with energy chains	Weather-resistant	High load bearing capacity	Suitable for pressures up to 35 bar	Resistant to welding spatter	DIN 73378 KFZ approval	Highly resistant to temperature and chemicals	Highly resistant to temperature and chemicals	

- 1) Other media on request
- 2) Suitable for use with food in accordance with supplementary material information/declaration of conformity → www.festo.com/supportportal
- 3) O.D. 3 mm and above
- +++ Highly suitable
- ++ Very suitable
- + Limited suitability (on request)
- Not suitable

Fittings

Material	Polymer				Metal					
	Designation	NPKA → npka	NPQP → npqp	QS, QSM → 293, 291	QS-V0 → qs-v0	NPQM → npqm	NPQH → 298	NPFC → 302	NPCK → npck	CRQS → crqs
Operating medium	Compressed air, vacuum, water ¹⁾	Compressed air, vacuum	Compressed air, vacuum, water ¹⁾	Compressed air, vacuum, water ¹⁾	Compressed air, vacuum, water ¹⁾	Compressed air, vacuum, water ¹⁾	Compressed air, vacuum, water ¹⁾	Compressed air, vacuum ¹⁾	Compressed air, vacuum, water ¹⁾	Compressed air, vacuum, water ¹⁾
Temperature [°C]	-10 ... +60	-20 ... +60	-10 ... +80	0 ... +60	-20 ... +70	0 ... +150	-20 ... +150	-20 ... +150	-20 ... +120	-15 ... +120
Temperature-dependent operating pressure [bar]	-0,95 ... +10	-0,95 ... +10	-0,95 ... +14	-0,95 ... +10	-0,95 ... +16	-0,95 ... +20	-0,95 ... +50	-0,95 ... +12	-0,95 ... +10	
Housing material	POM and PA66	PP	PBT and nickel-plated brass	PBT	Nickel-plated brass	Nickel-plated brass	Nickel-plated brass	Stainless steel	Stainless steel	
Thread	G thread	R thread	M, G and R thread	G and R threads	M and G thread	M and G thread	M, G and R thread	M and G thread	M and R thread	
Resistant to chemicals	++	+++	+	+	+	++	+	+++	+++	
Food-safe ²⁾	²⁾	²⁾	-	-	-	²⁾	-	²⁾	²⁾	
Corrosion resistance class (CRC)	4	4	1	1	1	3	1	4	4	
Special features	Cleanroom-compatible, 100% polymer	Highly resistant to chemicals	Wide choice of variants	Resistant to welding spatter	Sturdy	Resistant to high temperatures	Economical, suitable for high pressure and temperature ranges	Clean design	Highly resistant to corrosion	

- 1) Other media on request
- 2) Suitable for use with food in accordance with supplementary material information/declaration of conformity → www.festo.com/supportportal
- +++ Highly suitable
- ++ Very suitable
- + Limited suitability (on request)
- Not suitable

Reliable selection has never been this easy: our Product Finder for tubing and fittings helps you to select a tailored combination. Get started by following these links:

- www.festo.com/productfinder/tubing
- www.festo.com/productfinder/fittings

Tubing > Standard O.D. tubing >

Plastic tubing PUN-H, hydrolysis-resistant



- Extremely flexible polyurethane tubing
- Suitable for use with energy chains
- Operating media: compressed air, vacuum, water
- PUN-H-T: transparent version for greater safety, e.g. solid particles can be detected immediately
- Food-safe (see → www.festo.com/sp/pun-h > "Certificates" tab) and FDA-compliant
- Individual configuration for plastic tubing

Order code – Basic design



Legend: Mandatory entry Optional entry

001	Type
PUN	Polyurethane tubing, standard O.D.
002	Alternative material characteristic
H	Hydrolysis-resistant
003	O.D. x wall thickness [mm]
2x0,4	2.0 x 0.4
3x0,5	3.0 x 0.5
4x0,75	4.0 x 0.75
6x1	6.0 x 1.0
8x1,25	8.0 x 1.25
10x1,5	10 x 1.5
12x2	12.0 x 2.0
14x2	14.0 x 2.0
16x2,5	16.0 x 2.5

004	Colour
NT	Natural
SW	Black
BL	Blue
SI	Silver
TBL	Translucent blue
TGE	Translucent yellow
TGN	Translucent green
TRT	Translucent red
TSW	Translucent black
005	Packaging unit
-	50 m

Product options

Materials:

- PUN (Standard) polyurethane
- PAN Polyamide
- PFAN Perfluoralkoxy alkane
- PEN Polyethylene

Certifications:

- CM Anti-static
- H Hydrolysis-resistant
- VO Flame-retardant to UL 94 V0
- R Sturdy
- MF Automotive approval certificate
- VOC Resistant to welding spatter

Paired tubing:

- DUO DUO tubing

Packaging units:

- 100 m, 200 m, 300 m, 400 m, 500 m

Customer-specific tubing inscription

Colours:

- GN Green
- RT Red
- WS White
- GE Yellow
- BR Brown
- BS Blue/Black



Configurable product





This product and all its product options can be ordered online via the configurator:

→ www.festo.com/catalogue/pun

Ordering – Basic design

003 O.D. [mm]	004 Colour	001 + 002 PUN-H: Polyurethane, hydrolysis-resistant		001 + 002 PUN-H-T: Polyurethane, hydrolysis-resistant, translucent	
		Type	Part no.	Type	Part no.
2	Natural	PUN-H-2x0,4-NT	133038	–	
	Black	PUN-H-2x0,4-SW	133039	–	
3	Natural	PUN-H-3x0,5-NT	197375	–	
	Silver	PUN-H-3x0,5-SI	558277	–	
	Blue	PUN-H-3x0,5-BL	197382	–	
	Black	PUN-H-3x0,5-SW	197389	–	
4	Natural	PUN-H-4x0,75-NT	197376	–	
	Silver	PUN-H-4x0,75-SI	558278	–	
	Yellow	–		PUN-H-4x0,75-TGE	8048679
	Red	–		PUN-H-4x0,75-TRT	8048675
	Green	–		PUN-H-4x0,75-TGN	8048677
	Blue	PUN-H-4x0,75-BL	197383	PUN-H-4x0,75-TBL	8048671
	Black	PUN-H-4x0,75-SW	197390	PUN-H-4x0,75-TSW	8048673
6	Natural	PUN-H-6x1-NT	197377	–	
	Silver	PUN-H-6x1-SI	558279	–	
	Yellow	–		PUN-H-6x1-TGE	8048689
	Red	–		PUN-H-6x1-TRT	8048685
	Green	–		PUN-H-6x1-TGN	8048687
	Blue	PUN-H-6x1-BL	197384	PUN-H-6x1-TBL	8048681
	Black	PUN-H-6x1-SW	197391	PUN-H-6x1-TSW	8048683
8	Natural	PUN-H-8x1,25-NT	197378	–	
	Silver	PUN-H-8x1,25-SI	558280	–	
	Yellow	–		PUN-H-8x1,25-TGE	8048699
	Red	–		PUN-H-8x1,25-TRT	8048695
	Green	–		PUN-H-8x1,25-TGN	8048697
	Blue	PUN-H-8x1,25-BL	197385	PUN-H-8x1,25-TBL	8048691
	Black	PUN-H-8x1,25-SW	197392	PUN-H-8x1,25-TSW	8048693
10	Natural	PUN-H-10x1,5-NT	197379	–	
	Silver	PUN-H-10x1,5-SI	558281	–	
	Yellow	–		PUN-H-10x1,5-TGE	8048709
	Red	–		PUN-H-10x1,5-TRT	8048705
	Green	–		PUN-H-10x1,5-TGN	8048707
	Blue	PUN-H-10x1,5-BL	197386	PUN-H-10x1,5-TBL	8048701
	Black	PUN-H-10x1,5-SW	197393	PUN-H-10x1,5-TSW	8048703
12	Natural	PUN-H-12x2-NT	197380	–	
	Silver	PUN-H-12x2-SI	558282	–	
	Yellow	–		PUN-H-12x2-TGE	8048719
	Red	–		PUN-H-12x2-TRT	8048715
	Green	–		PUN-H-12x2-TGN	8048717
	Blue	PUN-H-12x2-BL	197387	PUN-H-12x2-TBL	8048711
	Black	PUN-H-12x2-SW	197394	PUN-H-12x2-TSW	8048713
14	Blue	PUN-H-14x2-BL	570386	–	
	Black	PUN-H-14x2-SW	570387	–	
16	Natural	PUN-H-16x2,5-NT	197381	–	
	Silver	PUN-H-16x2,5-SI	558283	–	
	Blue	PUN-H-16x2,5-BL	197388	–	
	Black	PUN-H-16x2,5-SW	197395	–	

Tubing/fitting combination

Fitting	Tubing	
	PUN	PUN-H
Push-in fitting QSM, mini series → 291 	-	■ For O.D. 2 mm: recommended fitting
Push-in fitting QS, standard series → 293 	■ For O.D. 3 ... 12, 16 mm: recommended fitting	■ For O.D. 3 ... 12, 16 mm: recommended fitting
Push-in fitting NPQH, metal → 298 	■ For O.D. 4 ... 14 mm: recommended fitting	■ For O.D. 4 ... 14 mm: recommended fitting
Push-in fitting NPQM → npqm 	■ For O.D. 4 ... 14 mm	■ For O.D. 4 ... 14 mm
Quick connector CK → ck 	■ For O.D. 4 ... 8 mm	■ For O.D. 4 ... 8 mm

Push-in fittings/connectors QSM, mini series



QSM-G1/8-6-I



QSML-M5-6



QSMT-M5-6



QSMY-3



QSMS

- Simple and reliable connection and release
- Compact for maximum component density in confined installation spaces

Order code

001 002 003 004 005
 -

Legend: Mandatory entry Optional entry

001	Type
QSM	Push-in fitting/push-in connector, straight, mini series
QSML	Push-in fitting/push-in connector, L-shape, mini series
QSMT	Push-in connector, T-shape, mini series
QSMY	Push-in connector, Y-shape, mini series
QSMS	Push-in bulkhead connector, mini series

002	Pneumatic connection 1
M3	M thread M3
M5	M thread M5
M6	M thread M6
M7	M thread M7
G1/8	G thread G1/8
1/8	R thread R1/8
	3H Push-in sleeve 3 mm
	4 Push-in connector 4 mm
	4H Push-in sleeve 4 mm
	6 Push-in connector 6 mm
	6H Push-in sleeve 6 mm
	8 Push-in connector 8 mm
	10 Push-in connector 10 mm
	12 Push-in connector 12 mm

003	Pneumatic connection 2
-	Same size as connection 1
3	Push-in connector 3 mm
4	Push-in connector 4 mm
6	Push-in connector 6 mm

004	Packaging unit
-	10 pieces

005	Installation method
-	Standard
I	With internal hex

Product options

Push-in connector 2 mm
 Packaging unit 100 pieces

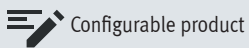

This product and all its product options can be ordered online via the configurator:

→ www.festo.com/catalogue/qsm

Fittings >

Push-in fittings/connectors QSM, mini series

Ordering

Push-in fitting QSM, straight
Male thread with external hex



Connection 1	Connection 2	Type	Part no.
M thread with sealing ring			
M3	3 mm	QSM-M3-3	153301
	4 mm	QSM-M3-4	153303
M5	3 mm	QSM-M5-3	153302
	4 mm	QSM-M5-4	153304
	6 mm	QSM-M5-6	153306
M6	6 mm	QSM-M6-6	132600
R thread			
R1/8	4 mm	QSM-1/8-4	153305
	6 mm	QSM-1/8-6	153307
G thread with sealing ring			
G1/8	4 mm	QSM-G1/8-4	186264
	6 mm	QSM-G1/8-6	186265

Push-in fitting QSML, L-shape, rotatable
Male thread with external hex

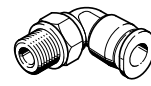

Connection 1	Connection 2	Type	Part no.
M thread with sealing ring			
M3	3 mm	QSML-M3-3	153330
	4 mm	QSML-M3-4	153332
M5	3 mm	QSML-M5-3	153331
	4 mm	QSML-M5-4	153333
	6 mm	QSML-M5-6	153335
M7	4 mm	QSML-M7-4	186352
	6 mm	QSML-M7-6	186353
R thread			
R1/8	4 mm	QSML-1/8-4	153334
	6 mm	QSML-1/8-6	153336
G thread with sealing ring			
G1/8	4 mm	QSML-G1/8-4	186268
	6 mm	QSML-G1/8-6	186269

Push-in connector QSM-...-1, straight
Male thread with internal hex



Connection 1	Connection 2	Type	Part no.
M thread with sealing ring			
M3	3 mm	QSM-M3-3-1	153312
	4 mm	QSM-M3-4-1	153314
M5	3 mm	QSM-M5-3-1	153313
	4 mm	QSM-M5-4-1	153315
	6 mm	QSM-M5-6-1	153317
M7	4 mm	QSM-M7-4-1	153319
	6 mm	QSM-M7-6-1	153321
R thread			
R1/8	4 mm	QSM-1/8-4-1	153316
	6 mm	QSM-1/8-6-1	153318
G thread with sealing ring			
G1/8	4 mm	QSM-G1/8-4-1	186266
	6 mm	QSM-G1/8-6-1	186267

Push-in L-connector QSML, L-shape



Connection 1	Connection 2	Type	Part no.
3 mm	3 mm	QSML-3	153343
4 mm	4 mm	QSML-4	153344
6 mm	6 mm	QSML-6	153345

Push-in L-connector QSML-...H, L-shape
With push-in sleeve



Connection 1	Connection 2	Type	Part no.
3 mm	3 mm	QSML-3H	153346
4 mm	4 mm	QSML-4H	153347
6 mm	6 mm	QSML-6H	153348
Reducing			
4 mm	3 mm	QSML-4H-3	153349
6 mm	4 mm	QSML-6H-4	153350

Push-in connector QSM, straight



Connection 1	Connection 2	Type	Part no.
3 mm	3 mm	QSM-3	153323
4 mm	4 mm	QSM-4	153324
6 mm	6 mm	QSM-6	153325
Reducing			
4 mm	3 mm	QSM-4-3	153326
6 mm	4 mm	QSM-6-4	153327

Push-in T-connector QSMT, T-shape

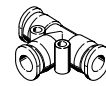

Connection 1	Connection 2	Type	Part no.
3 mm	3 mm	QSMT-3	153365
4 mm	4 mm	QSMT-4	153366
6 mm	6 mm	QSMT-6	153367
Reducing			
4 mm	3 mm	QSMT-4-3	153368
6 mm	4 mm	QSMT-6-4	153369

Push-in bulkhead connector QSMS



Connection 1	Connection 2	Type	Part no.
3 mm	3 mm	QSMS-3	153375
4 mm	4 mm	QSMS-4	153376
6 mm	6 mm	QSMS-6	153377

Push-in Y-connector QSMY, Y-shape

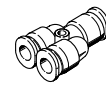

Connection 1	Connection 2	Type	Part no.
Push-in connector/push-in connector			
3 mm	3 mm	QSMY-3	153370
4 mm	4 mm	QSMY-4	153371
6 mm	6 mm	QSMY-6	153372
Reducing			
4 mm	3 mm	QSMY-4-3	153373
6 mm	4 mm	QSMY-6-4	153374

Push-in connector QSM-...H
With push-in sleeve

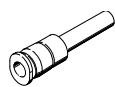

Connection 1	Connection 2	Type	Part no.
4 mm	3 mm	QSM-4H-3	153328
6 mm	4 mm	QSM-6H-4	153329

Push-in fittings/connectors QS, standard series



- Simple and reliable connection and release
- Wide selection for maximum flexibility in standard applications
- Male or female thread with external or internal hexagon
- Resistant to pressure: economical for pneumatic installations up to 14 bar

Order code

001 002 003 004 005 006 007

- - - - -

Legend: Mandatory entry Optional entry

001	Type
QS	Push-in fitting/push-in connector, straight, standard series
QSF	Push-in fitting, straight, standard series
QSL	Push-in fitting/push-in connector, L-shape, standard series
QSLL	Push-in fitting, L-shape, long, standard series
QSLF	Push-in fitting, L-shape, standard series
QSLV	Push-in fitting, L-shape, standard series
QST	Push-in fitting/push-in connector, T-shape, standard series
QSTL	Push-in fitting, T-shape, standard series
QSY	Push-in fitting/push-in connector, Y-shape, standard series
QSVL	Push-in fitting, Y-shape, standard series
QSS	Push-in bulkhead connector, standard series
QSC	Push-in cap/blanking plug, standard series

002	Pneumatic connection 1
M5	M thread M5
G1/8	G thread G1/8
G1/4	G thread G1/4
G3/8	G thread G3/8
G1/2	G thread G1/2
1/8	R thread R1/8
1/4	R thread R1/4
3/8	R thread R3/8
1/2	R thread R1/2

003	Additional feature
-	Standard
L	Long push-in sleeve
F	With fixed collar

004	Pneumatic connection 2
4	Push-in connector 4 mm
6	Push-in connector 6 mm
8	Push-in connector 8 mm
10	Push-in connector 10 mm
12	Push-in connector 12 mm
16	Push-in connector 16 mm

005	Packaging unit
-	10 pieces

006	Installation method
-	Standard
I	With internal hex

007	Generation
-	First generation
B	Second generation

004	Pneumatic connection 2
4	Push-in connector 4 mm
6	Push-in connector 6 mm
8	Push-in connector 8 mm
10	Push-in connector 10 mm
12	Push-in connector 12 mm
16	Push-in connector 16 mm

005	Packaging unit
-	10 pieces

006	Installation method
-	Standard
I	With internal hex

007	Generation
-	First generation
B	Second generation

004	Pneumatic connection 2
4	Push-in connector 4 mm
6	Push-in connector 6 mm
8	Push-in connector 8 mm
10	Push-in connector 10 mm
12	Push-in connector 12 mm
16	Push-in connector 16 mm

005	Packaging unit
-	10 pieces

006	Installation method
-	Standard
I	With internal hex

007	Generation
-	First generation
B	Second generation

004	Pneumatic connection 2
4	Push-in connector 4 mm
6	Push-in connector 6 mm
8	Push-in connector 8 mm
10	Push-in connector 10 mm
12	Push-in connector 12 mm
16	Push-in connector 16 mm

005	Packaging unit
-	10 pieces

006	Installation method
-	Standard
I	With internal hex

007	Generation
-	First generation
B	Second generation

004	Pneumatic connection 2
4	Push-in connector 4 mm
6	Push-in connector 6 mm
8	Push-in connector 8 mm
10	Push-in connector 10 mm
12	Push-in connector 12 mm
16	Push-in connector 16 mm

005	Packaging unit
-	10 pieces

006	Installation method
-	Standard
I	With internal hex

007	Generation
-	First generation
B	Second generation

004	Pneumatic connection 2
4	Push-in connector 4 mm
6	Push-in connector 6 mm
8	Push-in connector 8 mm
10	Push-in connector 10 mm
12	Push-in connector 12 mm
16	Push-in connector 16 mm

005	Packaging unit
-	10 pieces

006	Installation method
-	Standard
I	With internal hex

007	Generation
-	First generation
B	Second generation

004	Pneumatic connection 2
4	Push-in connector 4 mm
6	Push-in connector 6 mm
8	Push-in connector 8 mm
10	Push-in connector 10 mm
12	Push-in connector 12 mm
16	Push-in connector 16 mm

005	Packaging unit
-	10 pieces

006	Installation method
-	Standard
I	With internal hex

007	Generation
-	First generation
B	Second generation

004	Pneumatic connection 2
4	Push-in connector 4 mm
6	Push-in connector 6 mm
8	Push-in connector 8 mm
10	Push-in connector 10 mm
12	Push-in connector 12 mm
16	Push-in connector 16 mm

005	Packaging unit
-	10 pieces

006	Installation method
-	Standard
I	With internal hex

007	Generation
-	First generation
B	Second generation

004	Pneumatic connection 2
4	Push-in connector 4 mm
6	Push-in connector 6 mm
8	Push-in connector 8 mm
10	Push-in connector 10 mm
12	Push-in connector 12 mm
16	Push-in connector 16 mm

005	Packaging unit
-	10 pieces

006	Installation method
-	Standard
I	With internal hex

007	Generation
-	First generation
B	Second generation

004	Pneumatic connection 2
4	Push-in connector 4 mm
6	Push-in connector 6 mm
8	Push-in connector 8 mm
10	Push-in connector 10 mm
12	Push-in connector 12 mm
16	Push-in connector 16 mm

005	Packaging unit
-	10 pieces

006	Installation method
-	Standard
I	With internal hex

007	Generation
-	First generation
B	Second generation

004	Pneumatic connection 2
4	Push-in connector 4 mm
6	Push-in connector 6 mm
8	Push-in connector 8 mm
10	Push-in connector 10 mm
12	Push-in connector 12 mm
16	Push-in connector 16 mm

005	Packaging unit
-	10 pieces

006	Installation method
-	Standard
I	With internal hex

007	Generation
-	First generation
B	Second generation

Product options

Types:
 QS-V0, resistant to welding spatter
 CRQS, stainless steel

Designs:
 W-shape, X-shape

Packaging units:
 20 pieces, 50 pieces, 100 pieces

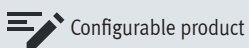

Configurable product

This product and all its product options can be ordered online via the configurator:

→ www.festo.com/catalogue/qs

Fittings >

Push-in fittings/connectors QS, standard series

Ordering

**Push-in fitting QS, straight
Male thread with external hex**

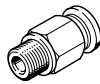

Connection 1	Connection 2	Type	Part no.
R thread			
R1/8	4 mm	QS-1/8-4	153001
	6 mm	QS-1/8-6	153002
	8 mm	QS-1/8-8	153004
	10 mm	QS-1/8-10	190643
R1/4	4 mm	QS-1/4-4	190644
	6 mm	QS-1/4-6	153003
	8 mm	QS-1/4-8	153005
	10 mm	QS-1/4-10	153007
	12 mm	QS-1/4-12	164980
R3/8	6 mm	QS-3/8-6	190645
	8 mm	QS-3/8-8	153006
	10 mm	QS-3/8-10	153008
	12 mm	QS-3/8-12	153009
	16 mm	QS-3/8-16 ¹⁾	164957
R1/2	10 mm	QS-1/2-10 ¹⁾	190646
	12 mm	QS-1/2-12 ¹⁾	153010
	16 mm	QS-1/2-16 ¹⁾	153011
G thread with sealing ring			
G1/8	4 mm	QS-G1/8-4	186095
	6 mm	QS-G1/8-6	186096
	8 mm	QS-G1/8-8	186098
G1/4	6 mm	QS-G1/4-6	186097
	8 mm	QS-G1/4-8	186099
	10 mm	QS-G1/4-10	186101
	12 mm	QS-G1/4-12	186350
G3/8	8 mm	QS-G3/8-8	186100
	10 mm	QS-G3/8-10	186102
	12 mm	QS-G3/8-12	186103
	16 mm	QS-G3/8-16 ¹⁾	186347
G1/2	12 mm	QS-G1/2-12 ¹⁾	186104
	16 mm	QS-G1/2-16 ¹⁾	186105

1) Packaging unit 1 piece

**Push-in fitting QS-...-I, straight
Male thread with internal hex**

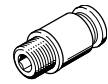

Connection 1	Connection 2	Type	Part no.
R thread			
R1/8	4 mm	QS-1/8-4-I	153012
	6 mm	QS-1/8-6-I	153013
	8 mm	QS-1/8-8-I	153015
	10 mm	QS-1/8-10-I	190647
R1/4	6 mm	QS-1/4-6-I	153014
	8 mm	QS-1/4-8-I	153016
	10 mm	QS-1/4-10-I	153018
	12 mm	QS-1/4-12-I	190649
R3/8	8 mm	QS-3/8-8-I	153017
	10 mm	QS-3/8-10-I	153019
	12 mm	QS-3/8-12-I	153020
R1/2	10 mm	QS-1/2-10-I ¹⁾	190648
	12 mm	QS-1/2-12-I ¹⁾	153021
G thread with sealing ring			
G1/8	4 mm	QS-G1/8-4-I	186106
	6 mm	QS-G1/8-6-I	186107
	8 mm	QS-G1/8-8-I	186109
	10 mm	QS-G1/8-10-I	132999
G1/4	6 mm	QS-G1/4-6-I	186108
	8 mm	QS-G1/4-8-I	186110
	10 mm	QS-G1/4-10-I	186112
G3/8	8 mm	QS-G3/8-8-I	186111
	10 mm	QS-G3/8-10-I	186113
	12 mm	QS-G3/8-12-I	186114
G1/2	12 mm	QS-G1/2-12-I ¹⁾	186115

1) Packaging unit 1 piece

**Push-in fitting QSF, straight
Female thread with external hex**

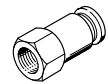

Connection 1	Connection 2	Type	Part no.
G thread			
G1/8	4 mm	QSF-1/8-4-B	153022
	6 mm	QSF-1/8-6-B	153023
	8 mm	QSF-1/8-8-B	153025
G1/4	4 mm	QSF-1/4-4-B	190650
	6 mm	QSF-1/4-6-B	153024
	8 mm	QSF-1/4-8-B	153026
	10 mm	QSF-1/4-10-B	153028
	12 mm	QSF-1/4-12-B	190651
G3/8	6 mm	QSF-3/8-6-B	190652
	8 mm	QSF-3/8-8-B	153027
	10 mm	QSF-3/8-10-B	153029
	12 mm	QSF-3/8-12-B	153030
G1/2	12 mm	QSF-1/2-12-B ¹⁾	190653
	16 mm	QSF-1/2-16-B ¹⁾	190654

1) Packaging unit 1 piece

Push-in fittings/connectors QS, standard series

Ordering

Push-in connector QS, straight



Connection 1	Connection 2	Type	Part no.
4 mm	4 mm	QS-4	153031
6 mm	6 mm	QS-6	153032
8 mm	8 mm	QS-8	153033
10 mm	10 mm	QS-10	153034
12 mm	12 mm	QS-12	153035
16 mm	16 mm	QS-16 ¹⁾	153036
Reducing			
6 mm	4 mm	QS-6-4	153037
8 mm	4 mm	QS-8-4	130606
	6 mm	QS-8-6	153038
10 mm	6 mm	QS-10-6	130607
	8 mm	QS-10-8	153039
12 mm	8 mm	QS-12-8	130608
	10 mm	QS-12-10	153040

1) Packaging unit 1 piece

Push-in bulkhead connector QSS



Connection 1	Connection 2	Type	Part no.
4 mm	4 mm	QSS-4	153157
6 mm	6 mm	QSS-6	153158
8 mm	8 mm	QSS-8	153159
10 mm	10 mm	QSS-10	153160
12 mm	12 mm	QSS-12	153161
With fixed collar			
8 mm	8 mm	QSS-8-F	130642
10 mm	10 mm	QSS-10-F	130643
12 mm	12 mm	QSS-12-F	130644

Push-in cap QSC



Connection 1	Connection 2	Type	Part no.
4 mm	-	QSC-4	153262
6 mm	-	QSC-6	153263
8 mm	-	QSC-8	153264
10 mm	-	QSC-10	153265
12 mm	-	QSC-12	153266

Push-in connector QS-...H, straight
With push-in sleeve

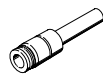

Connection 1	Connection 2	Type	Part no.
Reducing			
6 mm	4 mm	QS-6H-4	153041
8 mm	4 mm	QS-8H-4	130622
	6 mm	QS-8H-6	153042
10 mm	6 mm	QS-10H-6	130623
	8 mm	QS-10H-8	153043
12 mm	6 mm	QS-12H-6	132981
	8 mm	QS-12H-8	130624
	10 mm	QS-12H-10	153044

Blanking plug QSC-...H

Push-in sleeve

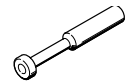

Connection 1	Connection 2	Type	Part no.
4 mm	Without	QSC-4H	153267
6 mm	Without	QSC-6H	153268
8 mm	Without	QSC-8H	153269
10 mm	Without	QSC-10H	153270
12 mm	Without	QSC-12H	153271
16 mm	Without	QSC-16H ¹⁾	153272

1) Packaging unit 1 piece

Push-in L-fitting QSL, L-shape, rotatable
Male thread with external hex



Connection 1	Connection 2	Type	Part no.	
R thread				
R1/8	4 mm	QSL-1/8-4	153045	
	6 mm	QSL-1/8-6	153046	
	8 mm	QSL-1/8-8	153048	
	10 mm	QSL-1/8-10	190658	
R1/4	4 mm	QSL-1/4-4	190659	
	6 mm	QSL-1/4-6	153047	
	8 mm	QSL-1/4-8	153049	
	10 mm	QSL-1/4-10	153051	
R3/8	12 mm	QSL-1/4-12	164981	
	6 mm	QSL-3/8-6	190660	
	8 mm	QSL-3/8-8	153050	
	10 mm	QSL-3/8-10	153052	
	12 mm	QSL-3/8-12	153053	
R1/2	16 mm	QSL-3/8-16 ¹⁾	164958	
	10 mm	QSL-1/2-10 ¹⁾	190661	
	12 mm	QSL-1/2-12 ¹⁾	153054	
	16 mm	QSL-1/2-16 ¹⁾	153055	
	G thread with sealing ring			
	G1/8	4 mm	QSL-G1/8-4	186116
6 mm		QSL-G1/8-6	186117	
8 mm		QSL-G1/8-8	186119	
G1/4	6 mm	QSL-G1/4-6	186118	
	8 mm	QSL-G1/4-8	186120	
	10 mm	QSL-G1/4-10	186122	
	12 mm	QSL-G1/4-12	186351	
G3/8	8 mm	QSL-G3/8-8	186121	
	10 mm	QSL-G3/8-10	186123	
	12 mm	QSL-G3/8-12	186124	
	16 mm	QSL-G3/8-16 ¹⁾	186348	
G1/2	12 mm	QSL-G1/2-12 ¹⁾	186125	
	16 mm	QSL-G1/2-16 ¹⁾	186126	

1) Packaging unit 1 piece

Fittings >

Push-in fittings/connectors QS, standard series

Ordering

Push-in fitting QSLL, L-shape, long, rotatable



Connection 1	Connection 2	Type	Part no.
R thread (male thread with external hexagon)/push-in connector			
R1/8	4 mm	QSLL-1/8-4	153076
	6 mm	QSLL-1/8-6	153077
	8 mm	QSLL-1/8-8	153079
R1/4	4 mm	QSLL-1/4-4	190662
	6 mm	QSLL-1/4-6	153078
	8 mm	QSLL-1/4-8	153080
	10 mm	QSLL-1/4-10	153082
R3/8	6 mm	QSLL-3/8-6	190663
	8 mm	QSLL-3/8-8	153081
	10 mm	QSLL-3/8-10	153083
	12 mm	QSLL-3/8-12	153084
R1/2	10 mm	QSLL-1/2-10 ¹⁾	190664
	12 mm	QSLL-1/2-12 ¹⁾	153085

1) Packaging unit 1 piece

Push-in L-fitting QSFL, L-shape, rotatable Female thread with external hex



Connection 1	Connection 2	Type	Part no.
G thread			
G1/8	4 mm	QSFL-1/8-4-B	153273
	6 mm	QSFL-1/8-6-B	153274
	8 mm	QSFL-1/8-8-B	153276
G1/4	6 mm	QSFL-1/4-6-B	153275
	8 mm	QSFL-1/4-8-B	153277
	10 mm	QSFL-1/4-10-B	153279
G3/8	8 mm	QSFL-3/8-8-B	153278
	10 mm	QSFL-3/8-10-B	153280

Push-in L-fitting QSLV, L-shape, rotatable Male thread with external hex



Connection 1	Connection 2	Type	Part no.
M thread			
M5	6 mm	QSLV-M5-6	190666
R thread			
R1/8	4 mm	QSLV-1/8-4	153086
	6 mm	QSLV-1/8-6	153087
	8 mm	QSLV-1/8-8	153089
R1/4	6 mm	QSLV-1/4-6	153088
	8 mm	QSLV-1/4-8	153090
	10 mm	QSLV-1/4-10	153092
R3/8	8 mm	QSLV-3/8-8	153091
	10 mm	QSLV-3/8-10	153093
	12 mm	QSLV-3/8-12	153094
R1/2	12 mm	QSLV-1/2-12 ¹⁾	153095
	16 mm	QSLV-1/2-16 ¹⁾	153096
	G thread		
G1/8	4 mm	QSLV-G1/8-4	186137
	6 mm	QSLV-G1/8-6	186138
	8 mm	QSLV-G1/8-8	186140
G1/4	6 mm	QSLV-G1/4-6	186139
	8 mm	QSLV-G1/4-8	186141
	10 mm	QSLV-G1/4-10	186143
G3/8	8 mm	QSLV-G3/8-8	186142
	10 mm	QSLV-G3/8-10	186144
	12 mm	QSLV-G3/8-12	186145
G1/2	12 mm	QSLV-G1/2-12 ¹⁾	186146
	16 mm	QSLV-G1/2-16 ¹⁾	186147

1) Packaging unit 1 piece

Push-in L-connector QSL, L-shape



Connection 1	Connection 2	Type	Part no.
4 mm	4 mm	QSL-4	153070
6 mm	6 mm	QSL-6	153071
8 mm	8 mm	QSL-8	153072
10 mm	10 mm	QSL-10	153073
12 mm	12 mm	QSL-12	153074
16 mm	16 mm	QSL-16 ¹⁾	153075

1) Packaging unit 1 piece

Push-in L-connector QSL...H, L-shape With push-in sleeve



Connection 1	Connection 2	Type	Part no.
4 mm	4 mm	QSL-4H	153056
6 mm	6 mm	QSL-6H	153057
8 mm	8 mm	QSL-8H	153058
10 mm	10 mm	QSL-10H	153059
12 mm	12 mm	QSL-12H	153060
Reducing			
6 mm	4 mm	QSL-6H-4	153061
8 mm	6 mm	QSL-8H-6	153062
10 mm	6 mm	QSL-10H-8	153063
12 mm	10 mm	QSL-12H-10	153064
Long push-in sleeve			
4 mm	4 mm	QSL-4HL	153065
6 mm	6 mm	QSL-6HL	153066
8 mm	8 mm	QSL-8HL	153067
10 mm	10 mm	QSL-10HL	153068
12 mm	12 mm	QSL-12HL	153069

Push-in T-fitting QST, T-shape, rotatable Male thread with external hex

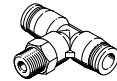

Connection 1	Connection 2	Type	Part no.
R thread			
R1/8	4 mm	QST-1/8-4	153106
	6 mm	QST-1/8-6	153107
	8 mm	QST-1/8-8	153109
	10 mm	QST-1/8-10	190667
R1/4	4 mm	QST-1/4-4	190668
	6 mm	QST-1/4-6	153108
	8 mm	QST-1/4-8	153110
	10 mm	QST-1/4-10	153112
R3/8	12 mm	QST-1/4-12	190669
	6 mm	QST-3/8-6	190670
	8 mm	QST-3/8-8	153111
	10 mm	QST-3/8-10	153113
R1/2	12 mm	QST-3/8-12	153114
	16 mm	QST-3/8-16 ¹⁾	164959
	10 mm	QST-1/2-10 ¹⁾	190672
	12 mm	QST-1/2-12 ¹⁾	153115
	16 mm	QST-1/2-16 ¹⁾	153116

1) Packaging unit 1 piece

Ordering

Push-in T-connector QST, T-shape

Connection 1	Connection 2	Type	Part no.
4 mm	4 mm	QST-4	153128
6 mm	6 mm	QST-6	153129
8 mm	8 mm	QST-8	153130
10 mm	10 mm	QST-10	153131
12 mm	12 mm	QST-12	153132
16 mm	16 mm	QST-16 ¹⁾	153133
Reducing			
6 mm	4 mm	QST-6-4	153134
8 mm	4 mm	QST-8-4	130613
	6 mm	QST-8-6	153135
10 mm	6 mm	QST-10-6	130614
	8 mm	QST-10-8	153136
12 mm	8 mm	QST-12-8	130615
	10 mm	QST-12-10	153137
16 mm	12 mm	QST-16-12 ¹⁾	130616



1) Packaging unit 1 piece

Push-in T-fitting QSTL, T-shape, rotatable
Male thread with external hex

Connection 1	Connection 2	Type	Part no.
R thread			
R1/8	4 mm	QSTL-1/8-4	153117
	6 mm	QSTL-1/8-6	153118
	8 mm	QSTL-1/8-8	153120
R1/4	6 mm	QSTL-1/4-6	153119
	8 mm	QSTL-1/4-8	153121
	10 mm	QSTL-1/4-10	153123
R3/8	8 mm	QSTL-3/8-8	153122
	10 mm	QSTL-3/8-10	153124
	12 mm	QSTL-3/8-12	153125
R1/2	12 mm	QSTL-1/2-12 ¹⁾	153126
	16 mm	QSTL-1/2-16 ¹⁾	153127

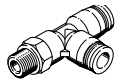

1) Packaging unit 1 piece

Push-in Y-fitting QSY, Y-shape, rotatable
Male thread with external hex

Connection 1	Connection 2	Type	Part no.
M thread with sealing ring			
M5	4 mm	QSY-M5-4	190673
	6 mm	QSY-M5-6	190674
R thread			
R1/8	4 mm	QSY-1/8-4	153138
	6 mm	QSY-1/8-6	153139
	8 mm	QSY-1/8-8	153141
R1/4	4 mm	QSY-1/4-4	190675
	6 mm	QSY-1/4-6	153140
	8 mm	QSY-1/4-8	153142
	10 mm	QSY-1/4-10	153144
R3/8	8 mm	QSY-3/8-8	153143
	10 mm	QSY-3/8-10	153145
	12 mm	QSY-3/8-12	153146
R1/2	10 mm	QSY-1/2-10 ¹⁾	133196
	12 mm	QSY-1/2-12 ¹⁾	153147

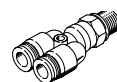

1) Packaging unit 1 piece

Push-in Y-connector QSY, Y-shape

Connection 1	Connection 2	Type	Part no.
Push-in connector/push-in connector			
4 mm	4 mm	QSY-4	153148
6 mm	6 mm	QSY-6	153149
8 mm	8 mm	QSY-8	153150
10 mm	10 mm	QSY-10	153151
12 mm	12 mm	QSY-12	153152
16 mm	16 mm	QSY-16 ¹⁾	130609
Reducing (2 reduced outlets)			
6 mm	4 mm	QSY-6-4	153153
8 mm	4 mm	QSY-8-4	130610
	6 mm	QSY-8-6	153154
10 mm	6 mm	QSY-10-6	130611
	8 mm	QSY-10-8	153155
12 mm	8 mm	QSY-12-8	130612
	10 mm	QSY-12-10	153156
16 mm	12 mm	QSY-16-12 ¹⁾	190708



1) Packaging unit 1 piece

Push-in Y-fitting QSYL, Y-shape, rotatable
Male thread with external hex

Connection 1	Connection 2	Type	Part no.
R thread			
R1/8	4 mm	QSYL-1/8-4 ¹⁾	153172
	6 mm	QSYL-1/8-6 ¹⁾	153173
	8 mm	QSYL-1/8-8 ¹⁾	153175
R1/4	6 mm	QSYL-1/4-6 ¹⁾	153174
	8 mm	QSYL-1/4-8 ¹⁾	153176
	10 mm	QSYL-1/4-10 ¹⁾	153178
R3/8	8 mm	QSYL-3/8-8 ¹⁾	153177
	10 mm	QSYL-3/8-10 ¹⁾	153179
	12 mm	QSYL-3/8-12 ¹⁾	153180
R1/2	12 mm	QSYL-1/2-12 ¹⁾	153181



1) Packaging unit 1 piece

Fittings >
Push-in fittings/connectors NPQH



- All metal push-in fitting/connector made of chemically nickel-plated brass
- High corrosion and chemical resistance
- FDA-compliant for the food and packaging industry (food-safe → www.festo.com/sp/npqh > "Certificates" tab)
- For pneumatic applications with a temperature range up to 150 °C and a pressure range up to 20 bar

Order code

001 002 003 004 005 006 007 008

NPQH - [] [] [] [] [] [] [] []

Legend: Mandatory entry Optional entry

001	Type		
NPQH	All metal push-in fitting/connector		
002	Design		
B	Plug screw		
D	Straight		
H	Push-in bulkhead connector		
L	L-shape		
P	Blanking plug		
T	T-shape		
Y	Y-shape		
003	Additional features		
-	Without		
L	Long		
004	Installation method		
-	Standard		
K	Internal hex		
005	Pneumatic connection 1		
M5	M thread M5	Q10	Push-in connector 10 mm
M7	M thread M7	Q12	Push-in connector 12 mm
G18	G thread G1/8	Q14	Push-in connector 14 mm
G14	G thread G1/4	S4	Push-in sleeve 4 mm
G38	G thread G3/8	S6	Push-in sleeve 6 mm
G12	G thread G1/2	S8	Push-in sleeve 8 mm
Q4	Push-in connector 4 mm	S10	Push-in sleeve 10 mm
Q6	Push-in connector 6 mm	S12	Push-in sleeve 12 mm
Q8	Push-in connector 8 mm	S14	Push-in sleeve 14 mm

006	Connection type		
-	Standard		
F	Female thread		
007	Pneumatic connection 2		
-	Without	Q14	Push-in connector 14 mm
E	Same size as connection 1	S4	Push-in sleeve 4 mm
Q4	Push-in connector 4 mm	S6	Push-in sleeve 6 mm
Q6	Push-in connector 6 mm	S8	Push-in sleeve 8 mm
Q8	Push-in connector 8 mm	S10	Push-in sleeve 10 mm
Q10	Push-in connector 10 mm	S12	Push-in sleeve 12 mm
Q12	Push-in connector 12 mm	S14	Push-in sleeve 14 mm
008	Packaging unit		
-	1 piece		
P10	10 pieces		

Product options

- Additional features:
- S Rotatable
 - LS Long, rotatable

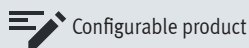

This product and all its product options can be ordered online via the configurator:

→ www.festo.com/catalogue/npqh

Ordering

Push-in fitting NPQH-D

Male thread with external hex



Connection 1	Connection 2	Type	Part no.
M thread with sealing ring			
M5	4 mm	NPQH-D-M5-Q4-P10	578334
	6 mm	NPQH-D-M5-Q6-P10	578335
M7	4 mm	NPQH-D-M7-Q4-P10	578336
	6 mm	NPQH-D-M7-Q6-P10	578337
G thread with sealing ring			
G1/8	4 mm	NPQH-D-G18-Q4-P10	578338
	6 mm	NPQH-D-G18-Q6-P10	578339
	8 mm	NPQH-D-G18-Q8-P10	578340
G1/4	6 mm	NPQH-D-G14-Q6-P10	578341
	8 mm	NPQH-D-G14-Q8-P10	578342
	10 mm	NPQH-D-G14-Q10-P10	578343
	12 mm	NPQH-D-G14-Q12-P10	578344
G3/8	8 mm	NPQH-D-G38-Q8-P10	578345
	10 mm	NPQH-D-G38-Q10-P10	578346
	12 mm	NPQH-D-G38-Q12-P10	578347
	14 mm	NPQH-D-G38-Q14-P10	578348
G1/2	10 mm	NPQH-D-G12-Q10	578349
	12 mm	NPQH-D-G12-Q12	578350
	14 mm	NPQH-D-G12-Q14	578351

Push-in fitting NPQH-D

Female thread with external hex



Connection 1	Connection 2	Type	Part no.
G1/8	4 mm	NPQH-D-G18F-Q4-P10	578352
	6 mm	NPQH-D-G18F-Q6-P10	578353
	8 mm	NPQH-D-G18F-Q8-P10	578354
G1/4	4 mm	NPQH-D-G14F-Q4-P10	578355
	6 mm	NPQH-D-G14F-Q6-P10	578356
	8 mm	NPQH-D-G14F-Q8-P10	578357

Push-in fitting NPQH-D

With push-in sleeve



Connection 1	Connection 2	Type	Part no.
M thread with sealing ring			
M5	4 mm	NPQH-D-M5-S4-P10	578358
	6 mm	NPQH-D-M5-S6-P10	578359
G thread with sealing ring			
G1/8	4 mm	NPQH-D-G18-S4-P10	578360
	6 mm	NPQH-D-G18-S6-P10	578361
	8 mm	NPQH-D-G18-S8-P10	578362
G1/4	6 mm	NPQH-D-G14-S6-P10	578363
	8 mm	NPQH-D-G14-S8-P10	578364
	10 mm	NPQH-D-G14-S10-P10	578365
	12 mm	NPQH-D-G14-S12-P10	578366
G3/8	10 mm	NPQH-D-G38-S10-P10	578367
	12 mm	NPQH-D-G38-S12-P10	578368
G1/2	12 mm	NPQH-D-G12-S12	578369

Push-in fitting NPQH-DK

Male thread with internal hex



Connection 1	Connection 2	Type	Part no.
M thread with sealing ring			
M5	4 mm	NPQH-DK-M5-Q4-P10	578370
	6 mm	NPQH-DK-M5-Q6-P10	578371
M7	4 mm	NPQH-DK-M7-Q4-P10	578372
	6 mm	NPQH-DK-M7-Q6-P10	578373
G thread with sealing ring			
G1/8	4 mm	NPQH-DK-G18-Q4-P10	578374
	6 mm	NPQH-DK-G18-Q6-P10	578375
	8 mm	NPQH-DK-G18-Q8-P10	578376
G1/4	8 mm	NPQH-DK-G14-Q8-P10	578377
	10 mm	NPQH-DK-G14-Q10-P10	578378
G3/8	12 mm	NPQH-DK-G38-Q12-P10	578379

Push-in connector NPQH-D

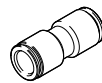

Connection 1	Connection 2	Type	Part no.
4 mm	4 mm	NPQH-D-Q4-E-P10	578323
6 mm	6 mm	NPQH-D-Q6-E-P10	578324
8 mm	8 mm	NPQH-D-Q8-E-P10	578325
10 mm	10 mm	NPQH-D-Q10-E-P10	578326
12 mm	12 mm	NPQH-D-Q12-E-P10	578327
14 mm	14 mm	NPQH-D-Q14-E-P10	578328

Push-in connector NPQH-D

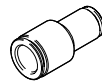

Connection 1	Connection 2	Type	Part no.
Reducing			
6 mm	4 mm	NPQH-D-Q6-Q4-P10	578329
8 mm	6 mm	NPQH-D-Q8-Q6-P10	578330
12 mm	8 mm	NPQH-D-Q12-Q8-P10	578331
14 mm	10 mm	NPQH-D-Q14-Q10-P10	578332
14 mm	12 mm	NPQH-D-Q14-Q12-P10	578333

Push-in connector NPQH-D

With push-in sleeve

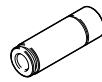

Connection 1	Connection 2	Type	Part no.
4 mm	6 mm	NPQH-D-S6-Q4-P10	578304
	8 mm	NPQH-D-S8-Q4-P10	578305
	10 mm	NPQH-D-S10-Q4-P10	578307
6 mm	8 mm	NPQH-D-S8-Q6-P10	578306
	10 mm	NPQH-D-S10-Q6-P10	578308
	12 mm	NPQH-D-S12-Q6-P10	578310
	14 mm	NPQH-D-S14-Q6-P10	578313
8 mm	10 mm	NPQH-D-S10-Q8-P10	578309
	12 mm	NPQH-D-S12-Q8-P10	578311
	14 mm	NPQH-D-S14-Q8-P10	578314
10 mm	12 mm	NPQH-D-S12-Q10-P10	578312
	14 mm	NPQH-D-S14-Q10-P10	578315
12 mm	14 mm	NPQH-D-S14-Q12-P10	578316

Fittings >
Push-in fittings/connectors NPQH

Ordering

Push-in sleeve NPQH-D

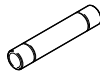

Connection 1	Connection 2	Type	Part no.
4 mm	4 mm	NPQH-D-S4-E-P10	578317
6 mm	6 mm	NPQH-D-S6-E-P10	578318
8 mm	8 mm	NPQH-D-S8-E-P10	578319
10 mm	10 mm	NPQH-D-S10-E-P10	578320
12 mm	12 mm	NPQH-D-S12-E-P10	578321
14 mm	14 mm	NPQH-D-S14-E-P10	578322

Push-in bulkhead fitting NPQH-H

Female thread with external hex



Connection 1	Connection 2	Type	Part no.
G thread with sealing ring			
G1/8	4 mm	NPQH-H-G18F-Q4-P10	578294
	6 mm	NPQH-H-G18F-Q6-P10	578295
	8 mm	NPQH-H-G18F-Q8-P10	578296
G1/4	6 mm	NPQH-H-G14F-Q6-P10	578297
	8 mm	NPQH-H-G14F-Q8-P10	578298

Push-in bulkhead fitting NPQH-H



Connection 1	Connection 2	Type	Part no.
4 mm	4 mm	NPQH-H-Q4-E-P10	578299
6 mm	6 mm	NPQH-H-Q6-E-P10	578300
8 mm	8 mm	NPQH-H-Q8-E-P10	578301
10 mm	10 mm	NPQH-H-Q10-E-P10	578302
12 mm	12 mm	NPQH-H-Q12-E-P10	578303

Blanking plug NPQH-P

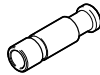

Connection 1	Connection 2	Type	Part no.
4 mm	-	NPQH-P-S4-P10	578257
6 mm	-	NPQH-P-S6-P10	578258
8 mm	-	NPQH-P-S8-P10	578259
10 mm	-	NPQH-P-S10-P10	578260
12 mm	-	NPQH-P-S12-P10	578261
14 mm	-	NPQH-P-S14-P10	578262

Plug screw NPQH-BK



Connection 1	Connection 2	Type	Part no.
M thread with sealing ring			
M5	-	NPQH-BK-M5-P10	578404
M7	-	NPQH-BK-M7-P10	578405
G thread with sealing ring			
G1/8	-	NPQH-BK-G18-P10	578406
G1/4	-	NPQH-BK-G14-P10	578407
G3/8	-	NPQH-BK-G38-P10	578408
G1/2	-	NPQH-BK-G12	578409

Push-in L-fitting NPQH-L

Rotatable 360°, male thread, with external hex



Connection 1	Connection 2	Type	Part no.
M thread with sealing ring			
M5	4 mm	NPQH-L-M5-Q4-P10	578276
	6 mm	NPQH-L-M5-Q6-P10	578277
M7	4 mm	NPQH-L-M7-Q4-P10	578278
	6 mm	NPQH-L-M7-Q6-P10	578279
G thread with sealing ring			
G1/8	4 mm	NPQH-L-G18-Q4-P10	578280
	6 mm	NPQH-L-G18-Q6-P10	578281
	8 mm	NPQH-L-G18-Q8-P10	578282
G1/4	6 mm	NPQH-L-G14-Q6-P10	578283
	8 mm	NPQH-L-G14-Q8-P10	578284
	10 mm	NPQH-L-G14-Q10-P10	578285
	12 mm	NPQH-L-G14-Q12-P10	578286
G3/8	8 mm	NPQH-L-G38-Q8-P10	578287
	10 mm	NPQH-L-G38-Q10-P10	578288
	12 mm	NPQH-L-G38-Q12-P10	578289
	14 mm	NPQH-L-G38-Q14-P10	578290
G1/2	10 mm	NPQH-L-G12-Q10	578291
	12 mm	NPQH-L-G12-Q12	578292
	14 mm	NPQH-L-G12-Q14	578293

Push-in L-fitting, long, NPQH-LL

Rotatable 360°, male thread, with external hex



Connection 1	Connection 2	Type	Part no.
G1/8	4 mm	NPQH-LL-G18-Q4-P10	578263
	6 mm	NPQH-LL-G18-Q6-P10	578264
	8 mm	NPQH-LL-G18-Q8-P10	578265
G1/4	6 mm	NPQH-LL-G14-Q6-P10	578266
	8 mm	NPQH-LL-G14-Q8-P10	578267
	10 mm	NPQH-LL-G14-Q10-P10	578268
G3/8	10 mm	NPQH-LL-G38-Q10-P10	578269

Push-in L-connector NPQH-L



Connection 1	Connection 2	Type	Part no.
4 mm	4 mm	NPQH-L-Q4-E-P10	578270
6 mm	6 mm	NPQH-L-Q6-E-P10	578271
8 mm	8 mm	NPQH-L-Q8-E-P10	578272
10 mm	10 mm	NPQH-L-Q10-E-P10	578273
12 mm	12 mm	NPQH-L-Q12-E-P10	578274
14 mm	14 mm	NPQH-L-Q14-E-P10	578275

Ordering

Push-in T-fitting NPQH-T

Rotatable 360°, male thread, with external hex



Connection 1	Connection 2	Type	Part no.
M thread with sealing ring			
M5	4 mm	NPQH-T-M5-Q4-P10	578390
	6 mm	NPQH-T-M5-Q6-P10	578391
G thread with sealing ring			
G1/8	4 mm	NPQH-T-G18-Q4-P10	578392
	6 mm	NPQH-T-G18-Q6-P10	578393
	8 mm	NPQH-T-G18-Q8-P10	578394
G1/4	6 mm	NPQH-T-G14-Q6-P10	578395
	8 mm	NPQH-T-G14-Q8-P10	578396
	10 mm	NPQH-T-G14-Q10-P10	578397
	12 mm	NPQH-T-G14-Q12-P10	578398
G3/8	8 mm	NPQH-T-G38-Q8-P10	578399
	10 mm	NPQH-T-G38-Q10-P10	578400
	12 mm	NPQH-T-G38-Q12-P10	578401
G1/2	10 mm	NPQH-T-G12-Q10	578402
	12 mm	NPQH-T-G12-Q12	578403

Push-in Y-connector NPQH-Y

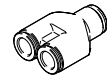

Connection 1	Connection 2	Type	Part no.
6 mm	6 mm	NPQH-Y-Q6-E-P10	578410
8 mm	8 mm	NPQH-Y-Q8-E-P10	578411
10 mm	10 mm	NPQH-Y-Q10-E-P10	578412
Reducing			
6 mm	4 mm	NPQH-Y-Q6-Q4-P10	578413
8 mm	6 mm	NPQH-Y-Q8-Q6-P10	578414
10 mm	8 mm	NPQH-Y-Q10-Q8-P10	578415

Push-in T-connector NPQH-T



Connection 1	Connection 2	Type	Part no.
4 mm	4 mm	NPQH-T-Q4-E-P10	578380
6 mm	6 mm	NPQH-T-Q6-E-P10	578381
8 mm	8 mm	NPQH-T-Q8-E-P10	578382
10 mm	10 mm	NPQH-T-Q10-E-P10	578383
12 mm	12 mm	NPQH-T-Q12-E-P10	578384
14 mm	14 mm	NPQH-T-Q14-E-P10	578385
Reducing			
6 mm	4 mm	NPQH-T-Q6-Q4-P10	578386
8 mm	6 mm	NPQH-T-Q8-Q6-P10	578387
10 mm	8 mm	NPQH-T-Q10-Q8-P10	578388
12 mm	10 mm	NPQH-T-Q12-Q10-P10	578389

Fittings >
Threaded fittings NPFC



- Nickel-plated brass
- Resistant to mechanical loads
- For service units, control cabinet construction or the easy installation of pneumatic controllers
- For pneumatic applications with a temperature range up to 150 °C and a pressure range up to 50 bar

Order code

001 002 003 004 005 006 007
 NPFC - - - - - -

Legend: Mandatory entry Optional entry

001	Type
NPFC	Threaded fitting
002	Design
S	Sleeve, straight
R	Reducing sleeve, straight
E...	Extension, straight, length 1 ... length 4
D	Double nipple, male thread/male thread
R	Reducing nipple
H	Bulkhead fitting
L	Fitting, L-shape
T	Fitting, T-shape
Y	Fitting, Y-shape
X	Fitting, X-shape

003	Number, connection type 1
-	1x available
2	2x available
3	3x available
4	4x available

004	Pneumatic connection 1		
M3	M thread M3	R18	R thread R1/8
M5	M thread M5	R14	R thread R1/4
M7	M thread M7	R38	R thread R3/8
G18	G thread G1/8	R12	R thread R1/2
G14	G thread G1/4	R34	R thread R3/4
G38	G thread G3/8	R1	R thread R1
G12	G thread G1/2		
G34	G thread G3/4		
G1	G thread G1		

005	Pneumatic connection 2		
M3	M thread M3	R18	R thread R1/8
M5	M thread M5	R14	R thread R1/4
M7	M thread M7	R38	R thread R3/8
G18	G thread G1/8	R12	R thread R1/2
G14	G thread G1/4	R34	R thread R3/4
G38	G thread G3/8	R1	R thread R1
G12	G thread G1/2		
G34	G thread G3/4		
G1	G thread G1		

006	Thread type
F	With female thread
M	With male thread

007	Packaging unit
-	10 pieces

Ordering

Sleeve NPFC-S, straight Female thread



Connection 1	Connection 2	Type	Part no.
M thread			
M5	M5	NPFC-S-2M5-F	8030290
G thread			
G1/8	G1/8	NPFC-S-2G18-F	8030291
G1/4	G1/4	NPFC-S-2G14-F	8030292
G3/8	G3/8	NPFC-S-2G38-F	8030293
G1/2	G1/2	NPFC-S-2G12-F	8030294
G3/4	G3/4	NPFC-S-2G34-F	8030295

Reducing sleeve NPFC-R, straight Female thread



Connection 1	Connection 2	Type	Part no.
M thread			
M5	G1/8	NPFC-R-G18-M5-F	8069219
G thread			
G1/8	G1/4	NPFC-R-G14-G18-F	8069220
	G3/8	NPFC-R-G38-G18-F	8030296
	G1/2	NPFC-R-G12-G18-F	8069222
G1/4	G3/8	NPFC-R-G38-G14-F	8069221
	G1/2	NPFC-R-G12-G14-F	8069223
G3/8	G1/2	NPFC-R-G12-G38-F	8069224
G1/2	G3/4	NPFC-R-G34-G12-F	8030297
	G1	NPFC-R-G1-G12-F	8069225
G3/4	G1	NPFC-R-G1-G34-F	8069226

Extension NPFC-E..., straight Male thread/female thread



Connection 1	Connection 2	Type	Part no.
Length 1			
M5	M5	NPFC-E1-2M5-FM	8069218
G1/8	G1/8	NPFC-E1-2G18-FM	8030298
G1/4	G1/4	NPFC-E1-2G14-FM	8030299
G3/8	G3/8	NPFC-E1-2G38-FM	8030300
G1/2	G1/2	NPFC-E1-2G12-FM	8030301
Length 2			
G1/8	G1/8	NPFC-E2-2G18-FM	8030302
G1/4	G1/4	NPFC-E2-2G14-FM	8030303
Length 3			
G1/8	G1/8	NPFC-E3-2G18-FM	8030304
G1/4	G1/4	NPFC-E3-2G14-FM	8030305
Length 4			
G1/8	G1/8	NPFC-E4-2G18-FM	8030306

Double nipple NPFC-D, straight Male thread



Connection 1	Connection 2	Type	Part no.
M thread			
M3	M3	NPFC-D-2M3-M	8069210
M5	M5	NPFC-D-2M5-M	8030267
	G1/8	NPFC-D-M5-G18-M	8069211
M7	G1/8	NPFC-D-M7-G18-M	8030268
G thread			
G1/8	G1/8	NPFC-D-2G18-M	8030269
	G1/4	NPFC-D-G18-G14-M	8030270
	G3/8	NPFC-D-G18-G38-M	8030271
G1/4	G1/4	NPFC-D-2G14-M	8030272
	G3/8	NPFC-D-G14-G38-M	8030273
	G1/2	NPFC-D-G14-G12-M	8030274
G3/8	G3/8	NPFC-D-2G38-M	8030275
	G1/2	NPFC-D-G38-G12-M	8030276
G1/2	G1/2	NPFC-D-2G12-M	8030277
	G3/4	NPFC-D-G12-G34-M	8069216
G3/4	G3/4	NPFC-D-2G34-M	8069217
R thread			
R1/8	R1/8	NPFC-D-2R18-M	8030278
	R1/4	NPFC-D-R18-R14-M	8030279
	R3/8	NPFC-D-R18-R38-M	8030280
R1/4	R1/4	NPFC-D-2R14-M	8030281
	R3/8	NPFC-D-R14-R38-M	8030282
	R1/2	NPFC-D-R14-R12-M	8030283
R3/8	R3/8	NPFC-D-2R38-M	8030284
	R1/2	NPFC-D-R38-R12-M	8030285
R1/2	R1/2	NPFC-D-2R12-M	8030286
	R3/4	NPFC-D-R12-R34-M	8030287
R3/4	R3/4	NPFC-D-2R34-M	8030288
R1	R1	NPFC-D-2R1-M	8030289

Reducing nipple NPFC-R



Connection 1	Connection 2	Type	Part no.
Female thread/male thread			
M5	G1/8	NPFC-R-G18-M5-FM	8030314
G1/8	G1/4	NPFC-R-G14-G18-FM	8030315
	G3/8	NPFC-R-G38-G18-FM	8030316
G1/4	G3/8	NPFC-R-G38-G14-FM	8030317
G3/8	G1/4	NPFC-R-G12-G38-FM	8030318
Male thread/female thread			
M5	M3	NPFC-R-M5-M3-MF	8069227
M7	M5	NPFC-R-M7-M5-MF	8069228
G1/8	M5	NPFC-R-G18-M5-MF	8030307
G1/4	M5	NPFC-R-G14-M5-MF	8069229
	G1/8	NPFC-R-G14-G18-MF	8030308
G3/8	G1/8	NPFC-R-G38-G18-MF	8030309
	G1/4	NPFC-R-G38-G14-MF	8030310
G1/2	G1/4	NPFC-R-G12-G14-MF	8030311
G1/2	G3/8	NPFC-R-G12-G38-MF	8030312
G3/4	G1/4	NPFC-R-G34-G14-MF	8069234
	G3/8	NPFC-R-G34-G38-MF	8069235
	G1/2	NPFC-R-G34-G12-MF	8030313
G1	G1/2	NPFC-R-G1-G12-MF	8069237
	G3/4	NPFC-R-G1-G34-MF	8069238

Fittings >

Threaded fittings NPFC

Ordering

Bulkhead fitting NPFC-H



Connection 1	Connection 2	Type	Part no.
Female thread/female thread			
M5	M5	NPFC-H-M5-F	8069239
G1/8	G1/8	NPFC-H-G18-F	8069240
G1/4	G1/4	NPFC-H-G14-F	8069241
G3/8	G3/8	NPFC-H-G38-F	8069242
G1/2	G1/2	NPFC-H-G12-F	8069243

Elbow fitting NPFC-L, L-shape



Connection 1	Connection 2	Type	Part no.
Female thread/female thread			
M5	M5	NPFC-L-2M5-F	8030208
G1/8	G1/8	NPFC-L-2G18-F	8030209
G1/4	G1/4	NPFC-L-2G14-F	8030210
G3/8	G3/8	NPFC-L-2G38-F	8030211
G1/2	G1/2	NPFC-L-2G12-F	8030212
G3/4	G3/4	NPFC-L-2G34-F	8030213
G1	G1	NPFC-L-2G1-F	8030214
Male thread/female thread			
M5	M5	NPFC-L-2M5-MF	8030215
R1/8	G1/8	NPFC-L-R18-G18-MF	8030216
R1/4	G1/4	NPFC-L-R14-G14-MF	8030217
R3/8	G3/8	NPFC-L-R38-G38-MF	8030218
R1/2	G1/2	NPFC-L-R12-G12-MF	8030219
R3/4	G3/4	NPFC-L-R34-G34-MF	8030220
R1	G1	NPFC-L-R1-G1-MF	8030221
Male thread/male thread			
M5	M5	NPFC-L-2M5-M	8030222
R1/8	R1/8	NPFC-L-2R18-M	8030223
R1/4	R1/4	NPFC-L-2R14-M	8030224
R3/8	R3/8	NPFC-L-2R38-M	8030225
R1/2	R1/2	NPFC-L-2R12-M	8030226
R3/4	R3/4	NPFC-L-2R34-M	8030227

T-fitting NPFC-T, T-shape

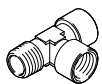

Connection 1	Connection 2	Type	Part no.
Female thread/female thread/female thread			
G1/8	G1/8	NPFC-T-3G18-F	8030235
G1/4	G1/4	NPFC-T-3G14-F	8030236
G3/8	G3/8	NPFC-T-3G38-F	8030237
G1/2	G1/2	NPFC-T-3G12-F	8030238
G3/4	G3/4	NPFC-T-3G34-F	8030239
G1	G1	NPFC-T-3G1-F	8030240
Female thread/male thread/female thread			
M5	M5	NPFC-T-3M5-FMF	8030245
G1/8	R1/8	NPFC-T-2G18-R18-FMF	8030246
G1/4	R1/4	NPFC-T-2G14-R14-FMF	8030247
G3/8	R3/8	NPFC-T-2G38-R38-FMF	8030248
G1/2	R1/2	NPFC-T-2G12-R12-FMF	8030249
G3/4	R3/4	NPFC-T-2G34-R34-FMF	8030250
G1	R1	NPFC-T-2G1-R1-FMF	8030251
Female thread/male thread/male thread			
G1/8	R1/8	NPFC-T-G18-2R18-FMM	8030255
G1/4	R1/4	NPFC-T-G14-2R14-FMM	8030256
G3/8	R3/8	NPFC-T-G38-2R38-FMM	8030257
G1/2	R1/2	NPFC-T-G12-2R12-FMM	8030258

T-fitting NPFC-T, T-shape

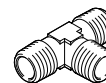

Connection 1	Connection 2	Type	Part no.
Male thread/male thread/male thread			
R1/4	R1/4	NPFC-T-3R14-M	8030252
R3/8	R3/8	NPFC-T-3R38-M	8030253
R1/2	R1/2	NPFC-T-3R12-M	8030254
Male thread/male thread/female thread			
R1/8	G1/8	NPFC-T-2R18-G18-MMF	8030259
R1/4	G1/4	NPFC-T-2R14-G14-MMF	8030260
R1/2	G1/2	NPFC-T-2R12-G12-MMF	8030261
Male thread/female thread/female thread			
M5	M5	NPFC-T-3M5-MFF	8069244
R1/8	G1/8	NPFC-T-R18-2G18-MFF	8030241
R1/4	G1/4	NPFC-T-R14-2G14-MFF	8030242
R3/8	G3/8	NPFC-T-R38-2G38-MFF	8030243
R1/2	G1/2	NPFC-T-R12-2G12-MFF	8030244

Fitting NPFC-Y, Y-shape



Connection 1	Connection 2	Type	Part no.
Female thread/female thread/female thread			
G1/4	G1/4	NPFC-Y-3G14-F	8030228
G3/8	G3/8	NPFC-Y-3G38-F	8030229
G1/2	G1/2	NPFC-Y-3G12-F	8030230
Male thread/female thread/female thread			
R1/8	G1/8	NPFC-Y-R18-2G18-MFF	8030231
R1/4	G1/4	NPFC-Y-R14-2G14-MFF	8030232
R3/8	G3/8	NPFC-Y-R38-2G38-MFF	8030233
R1/2	G1/2	NPFC-Y-R12-2G12-MFF	8030234

Fitting NPFC-X, X-shape

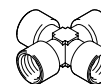

Connection 1	Connection 2	Type	Part no.
Female thread/female thread/female thread/female thread			
G1/4	G1/4	NPFC-X-4G14-F	8030262
G3/8	G3/8	NPFC-X-4G38-F	8030263
G1/2	G1/2	NPFC-X-4G12-F	8030264
Male thread/female thread/female thread/female thread			
G1/4	R1/4	NPFC-X-R14-3G14-MFFF	8030265
G1/2	R1/2	NPFC-X-R12-3G12-MFFF	8030266



B-M3-S9



B-M5



B

- With sealing ring
- High-alloy stainless steel, aluminium, steel
- M thread, G thread

Order code

001	002	003	004
B			

Legend: Mandatory entry Optional entry

001	Type
B	Blanking plug
002	Pneumatic connection
M3	M thread M3
M5	M thread M5
M7	M thread M7
1/8	G thread G1/8
1/4	G thread G1/4
3/8	G thread G3/8
1/2	G thread G1/2
3/4	G thread G3/4
1	G thread G1

003	Version
–	Standard
S9	Corrosion- and acid-resistant version
004	Generation
–	First generation
B	Second generation

Ordering

Blanking plug B				
Pneumatic connection	Material	Type	Part no.	PU ¹⁾
M thread				
With external hexagon and sealing ring				
M3	High-alloy stainless steel	B-M3-S9	30979	10
M5	Aluminium	B-M5	3843	10
With internal hex and sealing ring				
M5	Galvanised steel	B-M5-B	174308	10
M7		B-M7	174309	10
G thread				
With internal hex and sealing ring				
G1/8	Galvanised steel	B-1/8	3568	10
G1/4		B-1/4	3569	10
G3/8		B-3/8	3570	10
G1/2		B-1/2	3571	10
G3/4		B-3/4	3572	1
G1		B-1	5763	1

1) Packaging unit.

Couplings >

Quick coupling sockets/plugs NPHS, KD/KS



Safety coupling NPHS

- To ISO 4414
- Releasing sleeve made of metal or polymer
- Integrated hand slide valve
- Shut-off at one end

Plug-in coupling KD4/KS4

- For standard applications, without safety function
- Housing made from nickel-plated brass
- Releasing sleeve made from polymer
- Shut-off at one end

Order code

Safety coupling NPHS

001 002 003 004 005 006
 NPHS - 6 - -

001	Type
NPHS	Safety coupling
002	Coupling element
D	Quick coupling socket
S	Quick coupling plug
003	Coupling size
6	Size 6
004	Releasing sleeve version
M	Metal
P	Polymer
005	Pneumatic connection 1
G18	G1/8
G14	G1/4
G38	G3/8
G12	G1/2
006	Thread type connection 1
-	Male thread
F	Female thread

Order code

Plug-in coupling KD/KS

001 002 003 004
 4 - - A

001	Type
KD	Plug-in coupling with quick coupling socket
KS	Plug-in coupling with quick coupling plug
002	Coupling size
4	Size 4
003	Pneumatic connection 1
1/4	G1/4
3/8	G3/8
1/2	G1/2
004	Thread type connection 1
A	Male thread

Legend: Mandatory entry Optional entries

Product options

Pneumatic connection 1:

- Barbed fitting
- Female thread
- Quick connector with union nut
- Bulkhead quick connector with union nut

Configurable product

This product and all its product options can be ordered online via the configurator:

→ www.festo.com/catalogue/nphs

→ www.festo.com/catalogue/kd

Ordering – Quick coupling socket/plug NPHS

Quick coupling socket/plug combination NPHS – 004 Metal releasing sleeve			Quick coupling socket NPHS-D6-M			
		Type	–	NPHS-D6-M-G14	NPHS-D6-M-G38	NPHS-D6-M-G12
		Part no.	–	8059275	8059276	8059277
			Male thread G1/8	Male thread G1/4	Male thread G3/8	Male thread G1/2
Standard nominal flow rate $q_{nN}^{(1)}$ for quick coupling socket/plug combination						
Quick coupling plug NPHS-S6	Male thread G1/4	NPHS-S6-M-G14	–	1833 l/min	2100 l/min	2100 l/min
		8059258				
	Male thread G3/8	NPHS-S6-M-G38	–	1800 l/min	2050 l/min	2050 l/min
		8059259				
	Male thread G1/2	NPHS-S6-M-G12	–	1750 l/min	2000 l/min	2000 l/min
		8059260				

1) Measured at $p_1 = 6$ bar and $\Delta p = 1$ bar

Quick coupling socket/plug combination NPHS – 004 Polymer releasing sleeve			Quick coupling socket NPHS-D6-P			
		Type	NPHS-D6-P-G18	NPHS-D6-P-G14	NPHS-D6-P-G38	NPHS-D6-P-G12
		Part no.	8059266	8059267	8059268	8059269
			Male thread G1/8	Male thread G1/4	Male thread G3/8	Male thread G1/2
Standard nominal flow rate $q_{nN}^{(1)}$ for quick coupling socket/plug combination						
Quick coupling plug NPHS-S6	Male thread G1/8	NPHS-S6-M-G18	875 l/min	1183 l/min	1216 l/min	1233 l/min
		8059257				
	Male thread G1/4	NPHS-S6-M-G14	1038 l/min	1916 l/min	2033 l/min	2016 l/min
		8059258				
	Male thread G3/8	NPHS-S6-M-G38	1038 l/min	1883 l/min	2033 l/min	1983 l/min
		8059259				
	Male thread G1/2	NPHS-S6-M-G12	1002 l/min	1883 l/min	1966 l/min	1950 l/min
		8059260				
Quick coupling plug NPHS-S6	Female thread G1/4	NPHS-S6-M-G14F	1002 l/min	1883 l/min	1950 l/min	1916 l/min
		8059262				
	Female thread G3/8	NPHS-S6-M-G38F	1050 l/min	1966 l/min	2083 l/min	2016 l/min
		8059263				
	Female thread G1/2	NPHS-S6-M-G12F	1038 l/min	1883 l/min	2000 l/min	1983 l/min
		8059264				

1) Measured at $p_1 = 6$ bar and $\Delta p = 1$ bar

Ordering – Quick coupling socket/plug KD/KS

Combination of quick coupling socket KD4/plug KS4			Quick coupling socket KD4			
		Type	–	KD4-1/4-A	KD4-3/8-A	KD4-1/2-A
		Part no.	–	2143	2144	2145
			Male thread G1/8	Male thread G1/4	Male thread G3/8	Male thread G1/2
Standard nominal flow rate $q_{nN}^{(1)}$ for quick coupling socket/plug combination						
Quick coupling plug KS4	Male thread G1/4	KS4-1/4-A	–	1260 l/min	1242 l/min	1296 l/min
		2154				
	Male thread G3/8	KS4-3/8-A	–	1283 l/min	1274 l/min	1319 l/min
		2155				
	Male thread G1/2	KS4-1/2-A	–	1283 l/min	1260 l/min	1301 l/min
		531676				

1) Measured at $p_1 = 6$ bar and $\Delta p = 1$ bar

12

Control technology and software

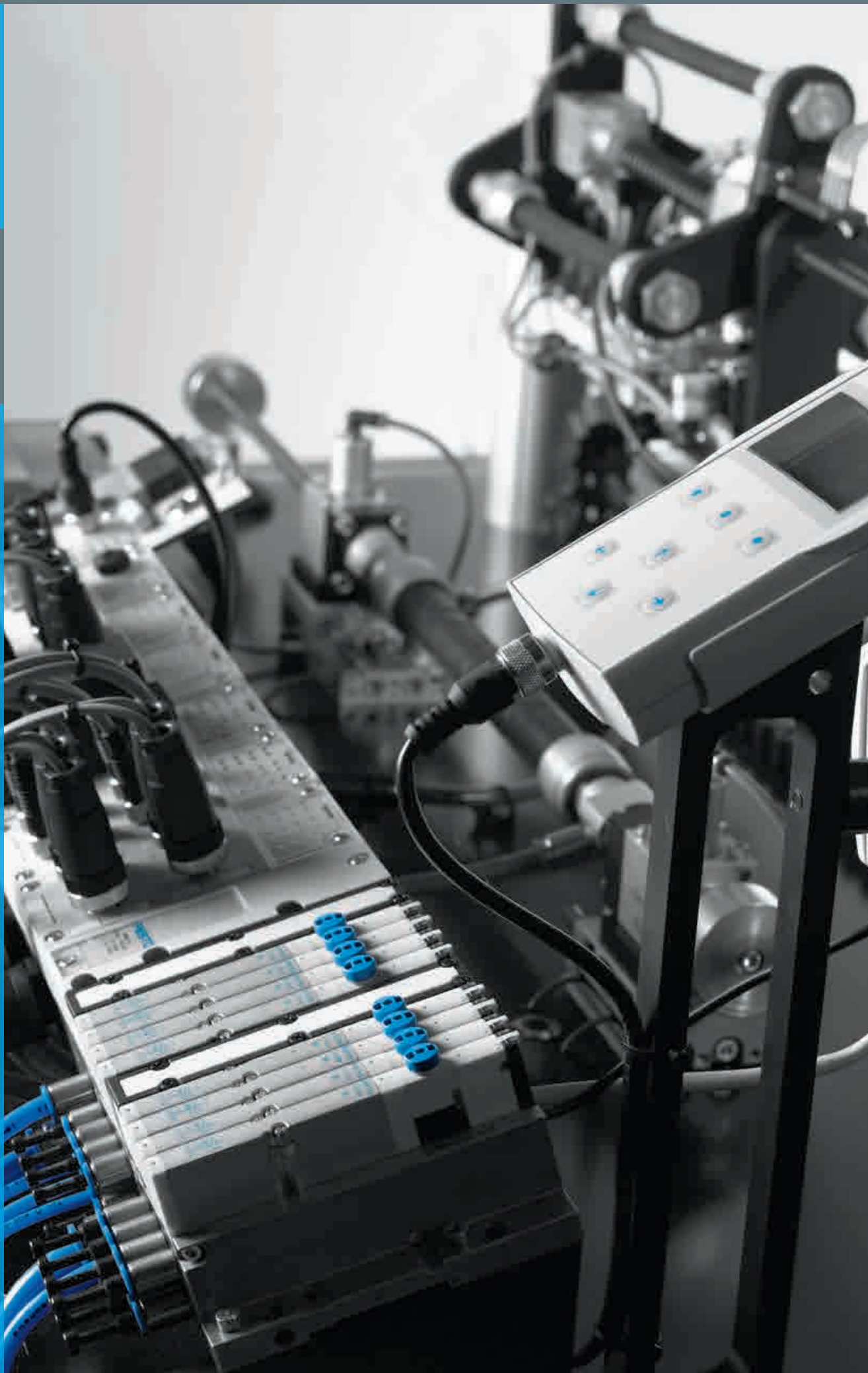

Highlights

Contents



Automation systems
CPX-AP-I

- + Best price/performance ratio by combining valve terminals and decentralised I/Os
- + IO-Link® master and IO-Link® device tool
- + Theoretically up to 500 modules in line, star and tree topology

→ 310



Terminals
CPX



- + Installation variants: stand-alone, remote I/O or with valve terminal VTSA/MPA
- + Digital or analogue input/output modules
- + Optional CODESYS controller

→ 310

Product overview _____ 310

Product overview

Electrical peripherals

	 Automation systems CPX-AP-I	 Terminals CPX	 Fieldbus modules CTEU
Protocol	IO-Link		AS-Interface, CANopen, CC-Link, CPI-B, DeviceNet, EtherCAT, EtherNet/IP, PROFINET, Modbus® TCP, PROFIBUS DP
Electrical control		Fieldbus, integrated controller	
Max. address capacity, inputs	244 ... 2048 Byte	64 Byte	2 ... 64 Byte
Max. address capacity, outputs	244 ... 2048 Byte	64 Byte	2 ... 64 Byte
Parameterisation		Diagnostic behaviour, failsafe response, forcing of channels, signal setup	Activate diagnostics, diagnostic behaviour, failsafe and idle response, failsafe response, IO-Link® mode, watchdog disable, watchdog enable
Degree of protection	IP65, IP67	IP65, IP67	IP65, IP67
Nominal operating voltage DC		24 V	24 ... 30 V
Operating voltage range DC		18 ... 30 V	18 ... 31.6 V
Description	<ul style="list-style-type: none"> • Simple integration into the controller of your choice: PROFINET, PROFIBUS, EtherCAT®, EtherNet/IP, ModbusTCP • Powerful remote I/O system that flexibly links 80 modules at a data rate of 200 Mbaud in real time • Cable lengths of up to 50 m between every module enable vast system dimensions • Real-time capability and deterministic system behaviour enable cycle times of up to 250 µs • The IO-Link® master and parameterisation software enable simple integration of any IO-Link® devices • Ethernet performance up to the valve terminal and digital as well as analogue input/output modules • Seamless connectivity along with advanced diagnostics option increase the machine availability and productivity 	<ul style="list-style-type: none"> • Automation platform • Open to all common fieldbus protocols and Ethernet • Integrated diagnostic and maintenance functions • Can be used as stand-alone as remote I/O or with valve terminals MPA-S, MPA-L, VTSA/VTSA-F • Choice of polymer or metal interlinking block with individual linking • Analogue inputs and outputs, 2-way/4-way, optionally with HART protocol 	<ul style="list-style-type: none"> • For valve terminals VTUB-12, VTUG, MPA-L, CPV, VTOC • Can be expanded into installation system CTEL • Fieldbus-typical LEDs, interfaces and switching elements • Isolated power supply for electronics and valves
→ Page/online	214	cpx	cteu

13

Other pneumatic equipment

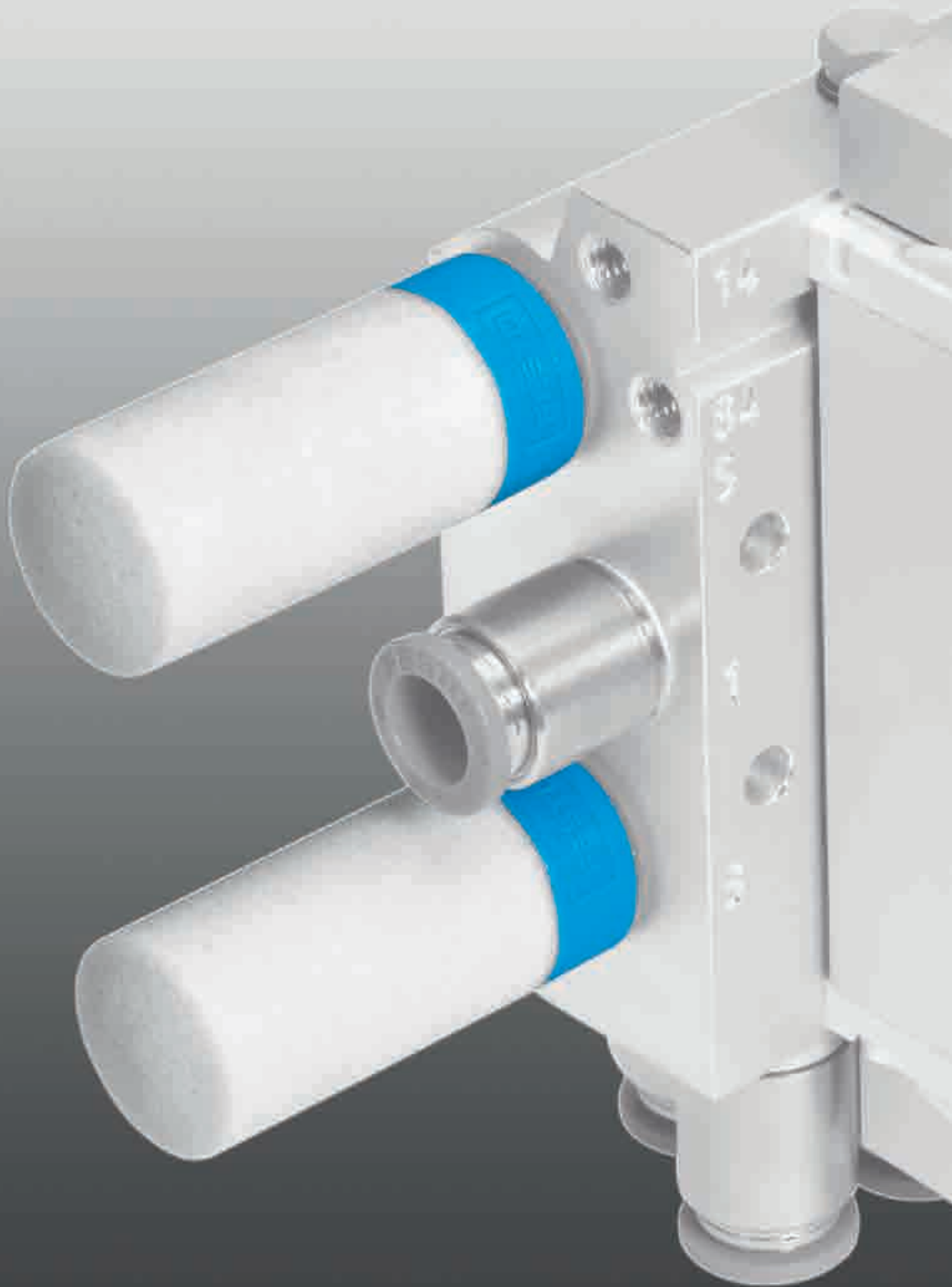

Highlights

Contents



Silencers
AMTE
+ Metal version
+ High temperature resistance up to 80 °C
+ Slim overall width
+ Many different variants
+ Universal applications

→ 316



Silencers
U
+ Polymer design
+ Connection thread G1/8, G1/4, G3/8, G1/2, G3/4, G1
+ Noise level 74 ... 90 dB(A)

→ 317



Product overview	314
Air reservoirs CRVZS	315
Silencers AMTE	316
Silencers U	317

Product overview

Reservoirs

	 <p>Air reservoirs CRVZS</p>
Volume	0.1 l, 0.4 l, 0.75 l, 10 l, 2 l, 20 l, 5 l
Information on air reservoir materials	High-alloy stainless steel
Conforms to standard	AD 2000
Condensate drain connection	G3/8
Description	<ul style="list-style-type: none"> • Corrosion-resistant • Can be used to compensate pressure fluctuations, and act as accumulators in the event of sudden air consumption • Providing large volumes of compressed air for supplying fast pulsing drives • With connection for condensate drain in some cases • Food-safe, see www.festo.com/sp/crvzs > "Certificates" tab • Designs to EU Pressure Equipment Directive EN 286-1 • Operating media: compressed air, vacuum
→ Page/online	315

Silencers

	 <p>Silencers AMTE</p>	 <p>Silencers U</p>	 <p>Silencers UOM, UOMS</p>
Information on silencer insert materials	Bronze	PE, bronze	PU foam
Pneumatic connection	G1, G1/2, G1/4, G1/8, G3/4, G3/8, M3, M5, NPT1/2-14, NPT1/4-18, NPT1/8-27, NPT3/8-18, UNF10-32	G1, G1/2, G1/4, G1/8, G3/4, G3/8, NPT3/4-14, PK-3, PK-4	G1/4, G3/8
Noise level	55 ... 95 dB(A)	70 ... 90 dB(A)	
Description	<ul style="list-style-type: none"> • Long or short design • Metal version • Operating medium: compressed air • High temperature resistance up to 80 °C • Slim overall width • Many different variants • Universal applications 	<ul style="list-style-type: none"> • Compact design, polymer or die-cast metal • Barbed connector or threaded connection • Operating medium: compressed air 	<ul style="list-style-type: none"> • Special open minimal resistance silencer • For vacuum generators • Facilitates trouble-free operation of the vacuum generator • Silencer extension for extending the silencer for further noise reduction • Operating medium: compressed air
→ Page/online	316	317	uom

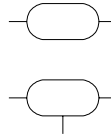

- Corrosion-resistant
- Volume up to 20 l
- Compensation of pressure fluctuations and as accumulators in the event of sudden air consumption

- Providing large volumes of compressed air for supplying fast pulsing drives
- Designs in accordance with EU Pressure Equipment Directive
- Optionally with condensate drain

Ordering

Pneumatic connection	Condensate drain connection	Type of mounting	Volume	Type	Part no.
G1/8	–	Via retaining clips	0.1 l ±20%	CRVZS-0.1	160233
G1/4	–	Via retaining clips	0.4 l ±20%	CRVZS-0.4	160234
		Via retaining clips	0.75 l ±20%	CRVZS-0.75	160235
G1/2	–	Via through-hole	2 l ±10%	CRVZS-2	160236
G1	G3/8	Via through-hole	5 l ±10%	CRVZS-5	192159
		Via through-hole	10 l ±10%	CRVZS-10	160237
		Via through-hole	20 l ±10%	CRVZS-20	534845

Silencers AMTE



- Suitable for reducing noise at the exhaust ports of pneumatic systems

- Metal version
- Long design

Ordering

Version	Type	Part no.	PU ¹⁾	Connection D1		Noise level [dB (A)]
				M thread	G thread	
Long design						
	AMTE-M-LH-M5	1205858	20	M5	–	< 72
	AMTE-M-LH-G18	1205860	20	–	G1/8	< 76
	AMTE-M-LH-G14	1205861	20	–	G1/4	< 83
	AMTE-M-LH-G38	1205862	10	–	G3/8	< 82
	AMTE-M-LH-G12	1205863	10	–	G1/2	< 88
	AMTE-M-LH-G34	1205864	10	–	G3/4	< 85
	AMTE-M-LH-G1	1205865	10	–	G1	< 88

1) Packaging unit

Product options

Connection D1

- M3
- NPT thread

Short version

Silencers U



- For noise reduction at the exhaust ports of pneumatic components

- Polymer or die-cast metal design

Ordering

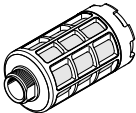
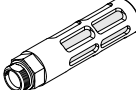
Version	Type	Part no.	PU ¹⁾	Connection D1 G thread	Noise level [dB (A)]
Polymer, male thread					
	U-1/8	2307	1	G1/8	74
	U-1/4	2316	1	G1/4	76
	U-3/8	2309	1	G3/8	82
	U-1/2	2310	1	G1/2	82
	U-3/4	2311	1	G3/4	85
	U-1	2312	1	G1	90
Die-cast metal					
	U-1/8-B	6841	1	G1/8	74
	U-1/4-B	6842	1	G1/4	80
	U-3/8-B	6843	1	G3/8	80
	U-1/2-B	6844	1	G1/2	81

1) Packaging unit

14

Process automation



Highlights



Limit switch attachments

SRBC

- + Weatherproof aluminium housing
- + Cost-optimised, high-performance and reliable series

→ 330



Positioners

CMSX

- + Ideal for proportional flow control at process valves (e.g. flow control, dispensing/mixing)
- + New features and optimised response and control characteristics

→ 334



Quarter turn actuators

DFPD

- + Flange hole pattern to ISO 5211
- + NAMUR connection pattern for solenoid valves and limit switch attachments to VDI/VDE 3845

→ 338



Angle seat valves

VZXA

- + Highly flexible, extremely high flow rates
- + Hygienic design, insensitive to dirt
- + Modular

→ 342

Contents

Standardising and automating process valves	320
Product overview	321
Limit switch attachments SRBC	330
Limit switch attachments SRBG	332
Positioners CMSX	334
Linear actuators DFPC	336
Quarter turn actuators DFPD	338
Ball valves VZBA	340
Angle seat valves VZXA	342
Pinch valves VZQA	344
Solenoid valves VZWD, directly actuated	346
Solenoid valves VZWF, force pilot operated	348
Solenoid valves VZWM	350
Ball valve actuator units VZBM	352
Ball valve actuator units VZBA	354
Filter regulators PCRP	358

Standardising and automating process valves

Fully automated process valves from a single source make planning, procurement and commissioning significantly easier and cost effective. They eliminate a considerable amount of project management work, reduce warehousing costs for spare parts, and speed up service and maintenance.

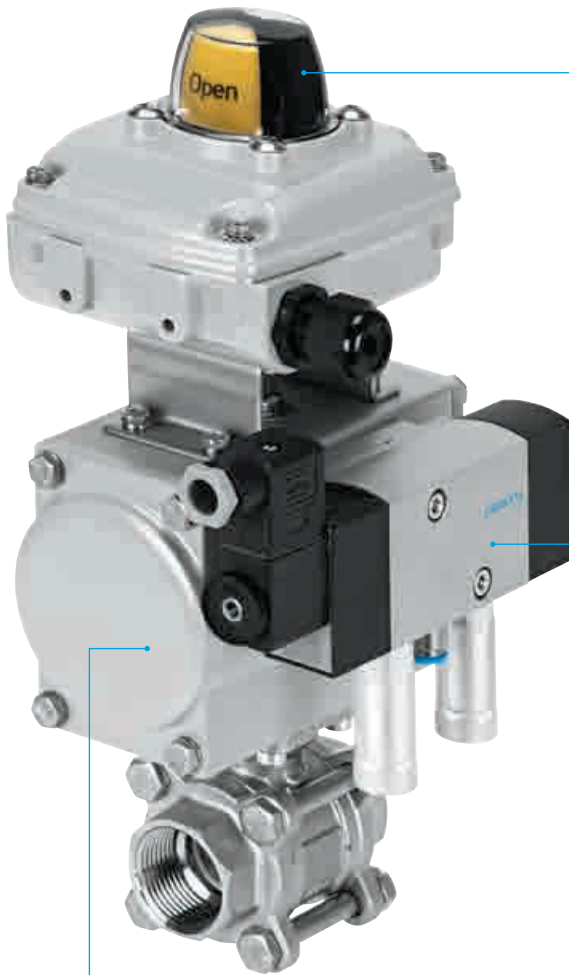

Quarter turn actuator DFPD

The new benchmark for quarter turn actuators. Its range of variants and standardised hole patterns to NAMUR VDI/VDE 3845 for pilot valves open up a wide variety of possible applications.
→ 324



Position sensing for all application areas

Whether an open solution with the sensor SRBG, the sturdy limit switch attachment SRBC for basic applications indoors and outdoors or the allrounder SRBE for explosion-proof areas. Festo always has the right solution.
→ 330



Alternative to the limit switch attachment: the reliable positioner CMSX for analogue closed-loop control

It enables the positions of quarter turn actuators to be accurately sensed and flow rates to be controlled, for example.
→ 323



Standard NAMUR valve VSNC

Controls quarter turn actuators and linear actuators with a VDI/VDE 3845 interface. Globally certified in accordance with current Ex standards. Now also available with poppet valve technology.
→ 157



Pilot valves VOFD/VOFC

An extremely sturdy alternative to the valve VSNC. Ideal for outdoor areas and potentially explosive atmospheres. The extremely sturdy VOFD/VOFC can control valve actuators in the chemical, petrochemical and pharmaceutical production plants of leading companies worldwide.
→ 321

Configurator for butterfly valve unit KVZA, ball valve unit KVZB, actuator unit KDFP





Software tools for easy selection and configuration of process valve units.
→ www.festo.com/process



We offer a wide selection of tubing and fittings for a broad range of applications, from standard applications to applications with specific external influences.
→ Pneumatic connection technology
→ 282



You can find the appropriate components here:
→ www.festo.com/productfinder/fittings

Pilot valves



	 Solenoid valves VSNC	 Solenoid valves VOFC	 Solenoid valves VOFD
Valve function	5/2-way, double solenoid, 5/2-way or 3/2-way, convertible, 5/3-way, pressurised, 5/3-way, exhausted, 5/3-way, closed, connections swapped	3/2-way, single solenoid, closed, 5/2-way, double solenoid, 5/2-way, single solenoid	3/2-way, single solenoid, closed, semi-automatic, 3/2-way, single solenoid, closed
Operating pressure	1.5 ... 10 bar	0 ... 10 bar	0 ... 12 bar
Ambient temperature	-20 ... 60°C	-25 ... 60°C	-50 ... 60°C
Pneumatic port 1	1/4 NPT, G1/4, G1/8, QS-1/4, QS-10, QS-3/8, QS-5/16, QS-6, QS-8	NAMUR connection pattern, 1/4 NPT, 1/2 NPT, G1/2, G1/4	NAMUR connection pattern, 1/4 NPT, G1/4, 1/2 NPT, G1/2
Standard nominal flow rate	500 ... 1350 l/min	766 ... 2686 l/min	52 ... 1900 l/min
Explosion prevention and protection	Class I, Div. 1 (US), AEx m II T4, for zone 1, 2, 21, 22, II 2G, II 2D, Class I, Div. 2 (US), II 3D, II 3G, Ex db IIC T4 Gb, Class II, Div. 1 (US), Ex db IIC T5 Gb, Class II, Div. 2 (US), Class III, Div. 1 (US), Class III, Div. 2 (US), EPL Da (IEC-EX), Ex ia IIIB T135°C Da, EPL Db (IEC-EX), EPL Db (KR), Ex mb tb IIIC T80°C, Ex t IIIC T80°C Db, EPL Dc (KR), Ex tb IIIC T100°C Db, Ex ia IIC T6 Ga, Ex tb IIIC T135°C Db, EPL Ga (IEC-EX), EPL Ga (KR), Ex ia IIC T6...T5 Ga, EPL Gb (IEC-EX), Ex mb IIC T6, EPL Gb (KR), Ex nA IIC T5 X Gc, EPL Gc (KR), Ex tc IIIC T95°C X Dc	II 2G, II 2D, for zones 1, 2, 21, 22, Ex ia IIIC T85°C, T125°C Db, EPL Db (IEC-EX), EPL Db (KR), Ex ia IIIC T6, T5 Gb, EPL Gb (IEC-EX), EPL Gb (KR)	II 2G, II 2D, for zone 1, 2, 21, 22, Ex d IIC T6, T5, T4 Gb, Ex eb mb IIC T6, T5 Gb
Description	<ul style="list-style-type: none"> • Connection pattern to NAMUR to VDI/VDE 3845 • Rotatable seal for 3/2-way or 5/2-way valve • Wide choice of EX solenoid systems • Sturdy and powerful • Extended temperature range • Outstanding value for money • All solenoid coils can be used on an armature tube • The VSNC...FN variant achieves higher energy efficiency with reduced power consumption 	<ul style="list-style-type: none"> • Suitable for process automation, for applications in chemical and petrochemical plants • Suitable for outdoor use under harsh ambient conditions • Especially suitable for quarter turn actuators thanks to NAMUR flange pattern • Valve can switch between internal and external pilot air • Variants with TÜV approval up to SIL3 to IEC 61508 • Variants to EU Explosion Protection Directive (ATEX) 	<ul style="list-style-type: none"> • Suitable for process automation, for applications in chemical and petrochemical plants • Suitable for outdoor use under harsh ambient conditions • Especially suitable for quarter turn actuators thanks to NAMUR flange pattern • Variants to EU Explosion Protection Directive (ATEX) • Variants with TÜV approval up to SIL3 to IEC 61508
→ Page/online	157	vofc	vofd

Product overview

Limit switch attachments

	 <p>Limit switch attachments SRBC</p>	 <p>Limit switch attachments SRBG</p>
Information on materials - housing	Die-cast aluminium	PBT
Operating voltage range AC	0 ... 250 V	
Operating voltage range DC	0 ... 175 V	6 ... 60 V
Measuring principle	Inductive, magnetic reed, mechanical/electrical	Inductive
Switching element function	N/C contact, N/O contact, toggle switch, single-pole	N/C contact, N/C contact or N/O contact, switchable, N/O contact
Description	<ul style="list-style-type: none"> • Pre-assembled mounting adapter for ease of installation • Trip cams can be set easily without additional tools • Sturdy, corrosion-resistant design, ideal for use in harsh ambient conditions • Clearly visible 3D position indicator allows rapid detection of the current position of the quarter turn actuator 	<ul style="list-style-type: none"> • Compact housing with M12 plug connection • Direct mounting on quarter turn actuators to VDI/VDE 3845 • AS-Interface version with extended addressing • Intrinsically safe version to ATEX and SIL 2 to IEC 61508
→ Page/online	330	332

Limit switch attachments

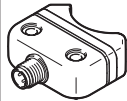
	 <p>Limit switch attachments SRAP</p>	 <p>Limit switch attachments SRBE</p>	 <p>Limit switch attachments SRBI</p>
Information on housing materials	Wrought aluminium alloy	Die-cast aluminium	PBT
Operating voltage range AC		0 ... 250 V	
Operating voltage range DC	15 ... 30 V	0 ... 60 V	10 ... 30 V
Measuring principle	Magnetic Hall	Inductive, magnetic reed, mechanical/electrical, for proximity sensor	Inductive
Switching element function		N/C contact, N/O contact, toggle switch, single-pole, toggle switch, double-pole	N/O contact
Description	<ul style="list-style-type: none"> • Based on standard VDI/VDE 3845 (NAMUR) • Analogue • For monitoring the position of quarter turn actuators • Sensors based on 2D Hall technology 	<ul style="list-style-type: none"> • Trip cams can be set easily without additional tools • Sturdy, corrosion-resistant design, ideal for use in harsh ambient conditions • Clearly visible 3D position indicator allows rapid detection of the current position of the quarter turn actuator 	<ul style="list-style-type: none"> • Compact housing with M12 plug connection • Direct mounting on quarter turn actuators to VDI/VDE 3845 • For quarter turn actuators for process automation with position indicators • LED status indicator for switching status and supply voltage
→ Page/online	srap	srbe	srbi

Accessories for limit switch attachments

	 <p>Position indicators SASF</p>
Setting range of swivel angle	0 ... 90 deg
Ambient temperature	-25 - 70°C
Type of mounting	To VDI/VDE 3845
Description	<ul style="list-style-type: none"> • For limit switch attachments SRBG • For mounting on drive shaft of standard actuators to VDI/VDE 3845 • Four actuating elements fixed at an offset of 90° • For clockwise and anticlockwise rotating actuators with 90° and 180° rotation
→ Page/online	333

Positioners

	 <p>Positioners CMSX</p>
Standard nominal flow rate	50 ... 130 l/min
Ambient temperature	-5 ... 60°C
Reference value	0 - 20 mA, 4 - 20 mA, 0 - 10
Operating voltage range DC	21.6 ... 26.4 V
Operating pressure	3 ... 8 bar
Safety information	<p>Safety position: in the case of a broken cable or operating voltage failure, the regulating action is to hold.</p> <p>Safety position: in the case of a broken cable or an operating voltage failure, the regulating action is opening/closing.</p>
Degree of protection	IP65
Type of mounting	Via accessories
Information on housing materials	Reinforced PC
Description	<ul style="list-style-type: none"> • Digital electropneumatic positioner for single-acting or double-acting pneumatic quarter turn actuators and double-acting pneumatic linear actuators • No air consumption in the regulated state
→ Page/online	334

Product overview

Actuators >

Linear actuators



Linear actuators
DFPC

Design	Piston, piston rod, tie rod, cylinder barrel
Mode of operation	Double-acting
Size of valve actuator	80, 100, 125
Stroke	10 ... 1600 mm
Operating pressure	0.6 ... 8 bar
Ambient temperature	-20 ... 80°C
Description	<ul style="list-style-type: none"> • Robust and corrosion-resistant tie-rod design • Ideal for use in harsh ambient conditions • Numerous configuration options • Variants with fastening interface to ISO 5210 or ISO 15552 with extended tie rods
→ Page/online	336

Actuators >

Quarter turn actuators



Quarter turn actuators
DFPD





Quarter turn actuators
DAPS

Design	Rack and pinion	Scotch yoke system
Mode of operation	Double-acting, single-acting	Double-acting, single-acting
Size of valve actuator	10, 20, 40, 80, 120, 160, 240, 300, 480, 700, 900, 1200, 2300	0008, 0015, 0030, 0053, 0060, 0090, 0106, 0120, 0180, 0240, 0360, 0480, 0720, 0960, 1440, 1920, 2880, 3840, 4000, 5760, 8000
Flange hole pattern	F03, F04, F05, F07, F10, F12, F14, F16, F0507, F0710, F1012, F1216	F03, F04, F05, F07, F10, F12, F14, F16, F25
Swivel angle	90°, 120°, 135°, 180°	90°, 92°
Ambient temperature	-50 ... 150°C	-50 ... 150°C
Operating pressure	2 ... 8 bar	1 ... 8.4 bar
Description	<ul style="list-style-type: none"> • Constant torque across the entire rotation angle range of 90° with the double-acting version • Process valve connection to ISO 5211 • Mounting hole pattern to VDI/VDE 3845 • Sturdy, non-slip and easy-to-clean aluminium housing • Long service life, low wear • Version with swivel angle 120°, 135°, 180° for the sizes 40, 120, 240, 480, double-acting 	<ul style="list-style-type: none"> • High breakaway torques • Flange hole pattern to ISO 5211 • Mounting hole pattern to VDI/VDE 3845 • Available with handwheel as a manual emergency override • Corrosion-resistant version made from stainless steel • To EU Explosion Protection Directive (ATEX)
→ Page/online	338	daps



Process valves >

Ball valves

	 Ball valves VZBD	 Ball valves VZBE	 Ball valves VZBF
Design	2-way ball valve	2-way ball valve, 2-way ball valve with hand lever, 3-way ball valve, L-shaped hole, T-shaped hole	2-way ball valve
Actuation type	Mechanical	Mechanical	Mechanical
Nominal width DN	15, 20, 25, 32, 40, 50, 65, 80, 100	8, 10, 15, 20, 25, 32, 40, 50, 65, 80, 100	15, 20, 25, 32, 40, 50, 65, 80, 100, 150, 200
Process valve connection	Clamp to ASME-BPE, clamp to DIN 32676 series B, weld-on end to ASME-BPE, weld-on to ISO 1127	1 NPT, 1 1/2 NPT, 1 1/4 NPT, 1/2 NPT, 1/4 NPT, 2 NPT, 2 1/2 NPT, 3 NPT, 3/4 NPT, 3/8 NPT, 4 NPT, weld-on end to ASME B16.11	Flange to ANSI B16.5 class 150
Flow rate Kv	3.5 ... 436.3 m ³ /h	5 ... 435.2 m ³ /h	8.5 ... 2078.3 m ³ /h
Temperature of medium	-20 ... 200°C	-20 ... 200°C	-20 ... 200°C
Nominal pressure PN of process valve	16	63	20
Description	<ul style="list-style-type: none"> • Electro-polished surfaces SFV4 • PTFE seal with only little dead space • The powerful ball valve for the pharmaceutical and cosmetic industries • FDA-compliant seal to FDA 21 CFR 177.1550 	<ul style="list-style-type: none"> • 2-way manual, with lockable hand lever • 2-way and 3-way with top flange to ISO 5211, optionally with lockable hand lever • Stainless steel design • Pipe thread to ASME B1.20.1 or welded end to ASME B16.11 • Optionally with pre-assembled hand lever 	<ul style="list-style-type: none"> • Flanged connections to ANSI B 16.5. class 150 • Static discharge ensured • API 607 Fire Safe approval • Stainless steel design • Easy to service • Optionally with pre-assembled hand lever
→ Page/online	vzbd	vzbe	vzbf

Process valves >



Ball valves

	 Ball valves VZBM	 Ball valves VZBC	 Ball valves VZBA
Design	2-way ball valve, 3-way ball valve, L-shaped hole, T-shaped hole	2-way ball valve	2-way ball valve, 3-way ball valve, L-shaped hole, T-shaped hole
Actuation type	Mechanical	Mechanical	Mechanical
Nominal width DN	8, 10, 15, 20, 25, 32, 40, 50	15, 20, 25, 32, 40, 50, 65, 80, 100	8, 10, 15, 20, 25, 32, 40, 50, 65, 80, 100
Process valve connection	Rp1, Rp1 1/2, Rp1 1/4, Rp1/2, Rp1/4, Rp2, Rp3/4, Rp3/8	Ring housing with threaded flange	Weld-on ends/weld-on ends, Rp1, Rp1 1/2, Rp1 1/4, Rp1/2, Rp1/4, Rp2, Rp2 1/2, Rp3, Rp3/4, Rp3/8, Rp4
Flow rate Kv	5.9 ... 243 m ³ /h	19.4 ... 1414 m ³ /h	7 ... 1414 m ³ /h
Temperature of medium	-20 ... 130°C	-10 ... 200°C	-10 ... 200°C
Nominal pressure PN of process valve	25, 40, 50	16, 40	63
Description	<ul style="list-style-type: none"> • Brass design • Pipe thread to EN 10226-1 	<ul style="list-style-type: none"> • Automatable 2-way compact flanged ball valve • Stainless steel design • Short installed length • Blow-out proof shaft • Manual operation possible using hand lever • Flange to DIN 1092-1 • Mounting flange to ISO 5211 • Use in zones 1, 21, 2, 22 	<ul style="list-style-type: none"> • Automatable 2-way or 3-way ball valve • Stainless steel design • Blow-out proof shaft • Manual operation possible using hand lever • Connecting thread to EN 10226-1 • Mounting flange to ISO 5211 • Use in zones 1, 21, 2, 22
→ Page/online	vzbm	vzbc	340

Product overview

Process valves >

Angle seat valves

	 Angle seat valves VZXF	 Angle seat valves VZXA
Design	Poppet valve with piston actuator	Poppet valve with piston actuator, poppet valve with diaphragm actuator
Actuator size	50 mm, 80 mm	46 mm, 75 mm, 90 mm
Valve function	2/2-way, closed, monostable	2/2
Control function	Closed by spring force, NC	Closed by reduced spring force, NC, double-acting, opened by spring force, NO, closed by spring force, NC
Actuation type	Pneumatic	Pneumatic
Nominal width DN	12, 13, 16, 18, 23, 24, 29, 31, 35, 43, 45	13, 20, 25, 32, 40, 50, 65
Flow rate Kv	3.3 ... 43 m ³ /h	6 ... 77.9 m ³ /h
Medium pressure	-0.9 ... 40 bar	-0.9 ... 30 bar
Temperature of medium	-40 ... 200°C	-30 ... 200°C
Nominal pressure PN of process valve	16, 40	25, 40
Description	<ul style="list-style-type: none"> • Sturdy design • Stainless steel and gunmetal (red brass) process valves with stainless steel, brass or aluminium actuators • Safety position "closing" • Different actuator sizes and housing materials • Selection of different seat and shaft seals • For liquids, gases and other easily contaminated media • Easy-to-clean design 	<ul style="list-style-type: none"> • Highly flexible, extremely high flow rates • Long service life • Stainless steel or Ecobrass process valves with stainless steel or polymer drives • Modular design • Hygienic design, insensitive to dirt • Quick and easy maintenance • Simple and sturdy: an ideal choice for virtually all media with a viscosity of up to 600 mm²/s • High chemical and thermal resistance • Variants to EU Explosion Protection Directive (ATEX)
→ Page/online	vzxf	342

Electrically actuated directional control valves >

Application-specific directional control valves

	 Pilot valves VOFX
Design	Directly actuated poppet valve
Valve function	3/2-way, single solenoid, closed
Operating pressure	-0.9 ... 8 bar
Ambient temperature	-10 ... 50°C
Pneumatic connection 1	G1/8
Standard nominal flow rate	50 l/min
Description	<ul style="list-style-type: none"> • For angle seat valves VZXF and VZXA • For use wherever valve terminals are not economically or technically viable • Manual override, detenting
→ Page/online	343



Process valves >

Pinch valves

	
	Pinch valves VZQA
Design	Pinch valve, pneumatically actuated
Actuation type	Pneumatic
Valve function	2/2-way, monostable, closed, 2/2-way, monostable, open
Nominal width DN	6, 15, 25
Process valve connection	Clamp to ASME-BPE type A, clamp to ASME-BPE type B, clamp to DIN 32676 series A, 1 NPT, 1/2 NPT, 1/4 NPT, G1, G1/2, G1/4
Flow rate Kv	0.7 ... 18 m ³ /h
Medium pressure	0 ... 6 bar
Temperature of medium	-5 ... 150°C
Nominal pressure PN of process valve	10
Description	<ul style="list-style-type: none"> • Modular design • Quick and easy replacement of the diaphragm • For critical, abrasive and viscous media • Easy-to-clean design • Flow direction is freely selectable • Versions with end-position sensing
→ Page/online	344

Process valves >



Solenoid actuated media valves

			
	Solenoid valves VZWD	Solenoid valves VZWF	Solenoid valves VZWM
Design	Directly actuated poppet valve	Diaphragm valve, force pilot operated	Diaphragm valve, servo-controlled
Actuation type	Electrical	Electrical	Electrical
Nominal width	1 ... 6 mm	13.5 ... 50 mm	13 ... 50 mm
Process valve connection	1/4 NPT, 1/8 NPT, G1/4, G1/8, NPT1/4	1 NPT, 1 1/2 NPT, 1 1/4 NPT, 1/2 NPT, 1/4 NPT, 2 NPT, 3/4 NPT, 3/8 NPT, G1, G1 1/2, G1 1/4, G1/2, G1/4, G2, G3/4, G3/8, NPT1, NPT1 1/2, NPT1 1/4, NPT1/2, NPT1/4, NPT2, NPT3/4, NPT3/8	G1, G1 1/2, G1 1/4, G1/2, G1/4, G2, G3/4, G3/8
Flow rate Kv	0.06 ... 430 l/min	1.8 ... 29900 l/min	1.6 ... 31000 l/min
Medium pressure	0 ... 90 bar	0 ... 10 bar	0.5 ... 10 bar
Temperature of medium	-10 ... 80°C	-10 ... 80°C	-10 ... 60°C
Description	<ul style="list-style-type: none"> • Extensive pressure range • Directly actuated poppet valve • No pressure difference required • Can also be used in vacuum technology 	<ul style="list-style-type: none"> • High flow rates • Large nominal diameters with relatively small solenoids • No pressure difference required • Can also be used in vacuum technology 	<ul style="list-style-type: none"> • Brass or stainless steel casting design • Electrical connection via solenoid armature tube • Wide range of coils • Coil can be ordered separately
→ Page/online	346	348	350

Product overview



Process valves >

Solenoid actuated media valves

	 Solenoid valves VZWP	 Reverse jet pulse valves VZWE-E, VZWE-F
Design	Pilot-actuated piston poppet valve	Angled version, straight version with flange, diaphragm valve
Actuation type	Electrical	Electrical
Nominal width	13 ... 25 mm	20 ... 76 mm
Process valve connection	1 NPT, 1/2 NPT, 1/4 NPT, 3/4 NPT, 3/8 NPT, G1, G1/2, G1/4, G3/4, G3/8	G1, G1 1/2, G2, G2 1/2, G3/4, flange diameter 60, 75, 89
Flow rate Kv	1.5 ... 12250 l/min	15 ... 210 m3/h
Medium pressure	0.5 ... 40 bar	0.35 ... 8 bar
Temperature of medium	-10 ... 80°C	
Description	<ul style="list-style-type: none"> • For all applications with a differential pressure of min. 0.5 bar • For high pressures and high flow rates with relatively small solenoids • For controlling gaseous and liquid media in open circuits 	<ul style="list-style-type: none"> • High flow rates • For mechanically cleaning filters and dust filter systems • Fast opening and closing times • Sturdy pilot system
→ Page/online	VZWP	VZWE

Process valve units >

Ball valve actuator units

	 Ball valve actuator units VZBM	 Ball valve actuator units VZBC	 Ball valve actuator units VZBA
Design	2-way ball valve, 3-way ball valve, quarter turn actuator	2-way ball valve, quarter turn actuator	2-way ball valve, 3-way ball valve, L-shaped hole, quarter turn actuator, T-shaped hole
Actuation type	Pneumatic	Pneumatic	Pneumatic
Nominal width DN	8, 10, 15, 20, 25, 32, 40, 50	15, 20, 25, 32, 40, 50, 65, 80, 100	8, 10, 15, 20, 25, 32, 40, 50, 65, 80, 100
Process valve connection	Rp1, Rp1 1/2, Rp1 1/4, Rp1/2, Rp1/4, Rp2, Rp3/4, Rp3/8	Ring housing with threaded flange	Weld-on ends/weld-on ends, Rp1, Rp1 1/2, Rp1 1/4, Rp1/2, Rp1/4, Rp2, Rp2 1/2, Rp3, Rp3/4, Rp3/8, Rp4
Flow rate Kv	5.9 ... 243 m ³ /h	19.4 ... 1414 m ³ /h	7 ... 1414 m ³ /h
Temperature of medium	-20 ... 130°C	-10 ... 200°C	-10 ... 200°C
Nominal pressure PN of process valve	25, 40	16, 40	63
Description	<ul style="list-style-type: none"> • Ball valve actuator unit with double-acting or single-acting quarter turn actuator DFPD • Brass ball valve • 2-way ball valve actuator unit with pipe thread to EN 10226-1 • 3-way ball valve actuator unit with L-shaped hole and pipe thread to EN 10226-1 • 3-way ball valve actuator unit with T-shaped hole and pipe thread to EN 10226-1 • Flow is fully opened or closed in both directions 	<ul style="list-style-type: none"> • Ball valve actuator unit with double-acting or single-acting quarter turn actuator DAPS • Stainless steel ball valve in compact design • NAMUR connection pattern for solenoid valves/limit switch attachments to VDI/VDE 3845 • Flow is fully opened or closed in both directions • Use in zones 1, 21, 2, 22 	<ul style="list-style-type: none"> • Ball valve actuator unit with double-acting or single-acting quarter turn actuator DAPS • Stainless steel ball valve • NAMUR connection pattern for solenoid valves/limit switch attachments to VDI/VDE 3845 • Flow is fully opened or closed in both directions • Use in zones 1, 21, 2, 22
online: →	352	vzbc	354

Compressed air preparation > Filter regulators >

Individual devices

	 <p>Filter regulators PCR</p>
Pneumatic connection 1	1/4 NPT, 1/2 NPT, G1/2, G1/4, NPT1/2-14, NPT1/4-18
Standard nominal flow rate	1920 ... 4115 l/min
Pressure regulation range	0.5 ... 12 bar
Operating pressure	1 ... 20 bar
Grade of filtration	5 µm, 40 µm
Description	<ul style="list-style-type: none"> • Robust housing for the specific requirements of process automation • Suitable for use outdoors and at temperatures down to -60 °C • Resistant to UV radiation and corrosive environments • With manual condensate drain, rotating • Size 64
→ Page/online	358

Limit switch attachments SRBC



- Measuring principle: electromagnetic, magnetic reed or inductive
- Switching element function: toggle switch, single-pole (SPDT)
- For DC and AC voltage
- Pre-assembled mounting adapter
- Ambient temperature -40° ... $+80^{\circ}\text{C}$
- Cable connector and blanking plug included in the scope of delivery
- Selected types in accordance with ATEX directive for potentially explosive atmospheres

→ www.festo.com/ex

*) Electrical output: 1WG

Order code

001	002	003	004	005	006	007	008	009	010	011
SRBC	C		YR	90						

Legend: Mandatory entry Optional entry

001	Type
SRBC	Limit switch attachment
002	Design
C	Design C
003	Mechanical interface
A3	Mounting adapter, hole pattern 80x30 mm, shaft height 20 mm
A4	Flexible mounting adapter (80x30 mm and 130x30 mm, shaft height 20 mm and 30 mm)
A5	EN ISO 5211/F05 (without mounting adapter)
004	Display type
YR	Position indicator yellow/red
005	Measuring range
90	0 ... 90°
006	Sensor principle
N	Proximity switch, inductive
R	Reed with contact
MW	Floating contact, changeover switch
007	Nominal operating voltage
2A	110 V AC, 50-60 Hz
20N	8.2 V DC, NAMUR
22A	250 V AC
1	24 V DC

008	Electrical output
1W	1-pin toggle switch
1WG	1-pin toggle switch (gold contact)
ZC	2-wire N/C contact
ZU	2-wire N/O contact
P	PNP
N	NPN
009	Electrical connection
C2	Screw terminal
M12	M12 plug, A-coded
010	Cable connector
-	None
P20	M20x1.5, polymer
011	EU certification
-	Without
EX6	II 1 GD



Configurable product

This product and all its product options can be ordered online via the configurator:

→ www.festo.com/catalogue/srbc

Ordering

007 Nominal operating voltage	008 Electrical output	009 Electrical connection	010 Cable conduit fitting	011 EU certification	Type	Part no.
006 Proximity switch, inductive						
003 Mounting adapter, hole pattern 80x30 mm, shaft height 20 mm						
8.2 V DC, NAMUR	2-wire N/C contact	Screw terminal	M20x1.5, polymer	–	SRBC-CA3-YR90-N-20N-ZC-C2P20	3482806
8.2 V DC, NAMUR	2-wire N/C	Screw terminal	M20x1.5, polymer	II2GD	SRBC-CA3-YR90-N-20N-ZC-C2P20-EX6	3482807
24 V DC	PNP	Screw terminal	M20x1.5, polymer	–	SRBC-CA3-YR90-N-1-P-C2P20	3482808
24 V DC	NPN	Screw terminal	M20x1.5, polymer	–	SRBC-CA3-YR90-N-1-N-C2P20	3482809
24 V DC	2-wire N/O contact	Screw terminal	M20x1.5, polymer	–	SRBC-CA3-YR90-N-1-ZU-C2P20	3482810
8.2 V DC, NAMUR	2-wire N/C	M12 plug, A-coded	–	–	SRBC-CA3-YR90-N-20N-ZC-M12	8137100
24 V DC	PNP	Plug M12, A-coded	–	–	SRBC-CA3-YR90-N-1-P-M12	8137101
003 Flexible mounting adapter (80x30 mm and 130x30 mm, shaft height 20 mm and 30 mm)						
8.2 V DC, NAMUR	2-wire N/C	Screw terminal	–	II2GD	SRBC-CA4-YR90-N-20N-ZC-C2-EX6	8137096
24 V DC	PNP	Screw terminal	–	–	SRBC-CA4-YR90-N-1-P-C2	8137097
003 Mechanical interface to EN ISO 5211/F05 (without mounting adapter)						
8.2 V DC, NAMUR	2-wire N/C	Screw terminal	–	II2GD	SRBC-CA5-YR90-N-20N-ZC-C2-EX6	8137105
24 V DC	PNP	Screw terminal	M20x1.5, polymer	–	SRBC-CA5-YR90-N-1-P-C2	8137106
006 Electromechanical and contacting reed						
003 Mounting adapter, hole pattern 80x30 mm, shaft height 20 mm						
007 110 V AC, 50-60 Hz	1-pin toggle switch	Screw terminal	M20x1.5, polymer	–	SRBC-CA3-YR90-R-2A-1W-C2P20	3482811
006 Floating contact, changeover switch						
003 Mounting adapter, hole pattern 80x30 mm, shaft height 20 mm						
250 V AC	1-pin toggle switch	Screw terminal	M20x1.5, polymer	–	SRBC-CA3-YR90-MW-22A-1W-C2P20	3482805
24 V DC	1-pin toggle switch (gold contact)	Screw terminal	–	II2GD	SRBC-CA3-YR90-MW-1-1WG-C2-EX6	8137093
24 V DC	1-pin toggle switch	Plug M12, A-coded	–	–	SRBC-CA3-YR90-MW-1-1W-M12	8137098
24 V DC	1-pin toggle switch (gold contact)	Plug M12, A-coded	–	–	SRBC-CA3-YR90-MW-1-1WG-M12	8137099
003 Flexible mounting adapter (80x30 mm and 130x30 mm, shaft height 20 mm and 30 mm)						
250 V AC	1-pin toggle switch	Screw terminal	–	–	SRBC-CA4-YR90-MW-22A-1W-C2	8137094
24 V DC	1-pin toggle switch (gold contact)	Screw terminal	–	II2GD	SRBC-CA4-YR90-MW-1-1WG-C2-EX6	8137095
24 V DC	1-pin toggle switch	Plug M12, A-coded	–	–	SRBC-CA4-YR90-MW-1-1W-M12	8137102
003 Mechanical interface to EN ISO 5211/F05 (without mounting adapter)						
250 V AC	1-pin toggle switch	Screw terminal	–	–	SRBC-CA5-YR90-MW-22A-1W-C2	8137103
24 V DC	1-pin toggle switch (gold contact)	Screw terminal	M20x1.5, polymer	II2GD	SRBC-CA5-YR90-MW-1-1WG-C2-EX6	8137104

Accessories

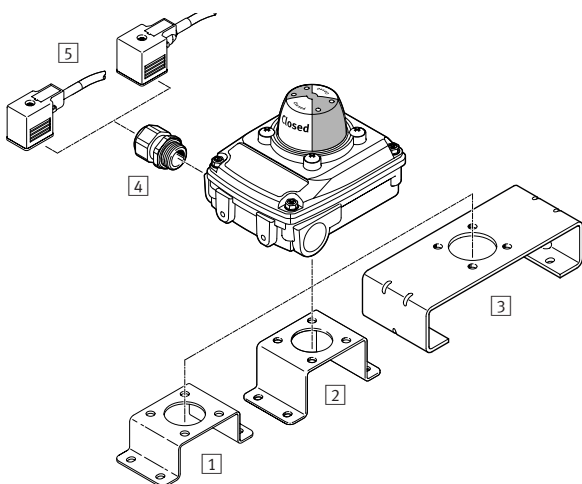

- 1) Mounting adapter for mounting on standard actuators in accordance with VDI/VDE 3845
DARQ-K-X1-A1-F05-20-R1¹⁾
→ 331
- 2) Mounting adapter for mounting on standard actuators in accordance with VDI/VDE 3845
DARQ-K-X1-A1-F05-30-R1
→ 331
- 3) Mounting adapter for mounting on standard actuators in accordance with VDI/VDE 3845
DARQ-K-X1-A2-F05-30-R1
→ 331
- 4) Cable connector NETC-P-M20¹⁾ → [srbc](#)
- 5) Connecting cables for valve connection with terminal rail connection NEBV → [srbc](#)

1) Included in the scope of delivery of the limit switch attachment.

1) Mounting adapter DARQ-K-X1-A1-F05-20-R1			
Actuator outlet hole pattern	Size	Type	Part no.
80x30 mm	20	DARQ-K-X1-A1-F05-20-R1	3636269

2) Mounting adapter DARQ-K-X1-A1-F05-30-R1			
Actuator outlet hole pattern	Size	Type	Part no.
80x30 mm	30	DARQ-K-X1-A1-F05-30-R1	3636270

3) Mounting adapter DARQ-K-X1-A1-F05-20-R1			
Actuator outlet hole pattern	Size	Type	Part no.
130x30 mm	30	DARQ-K-X1-A2-F05-30-R1	3886114

Limit switch attachments SRBG



SRBG...-M12



SRBG...-C2

- Inductive double sensor
- Direct mounting on quarter turn actuators to VDI/VDE 3845
- No adjustment is necessary when mounting the sensor
- For clockwise and anticlockwise rotating actuators with 90° and 180° rotation
- Selected types in accordance with ATEX directive for potentially explosive atmospheres
[→ www.festo.com/ex](http://www.festo.com/ex)

Order code – Basic design

001 002 003 004 005 006 007 008
SRBG - **C1** - **N** - **1** - - - -

Legend: Mandatory entry Optional entry

001	Type
SRBG	Limit switch attachment
002	Design
C1	Dual sensor
003	Sensor principle
N	Proximity switch, inductive
004	Nominal operating voltage
1	24 V DC
005	Electrical output
P	PNP
ZU	2-wire N/O contact
AS	AS-Interface®

006	Electrical connection
C2	Screw terminal
M12	M12 plug, A-coded
007	Electrical connection, valve
-	Without
C2	Screw terminal
M12	M12 plug, A-coded
008	EU certification
-	None

Product options

Nominal operating voltage
 • 8.2 V DC, NAMUR

Electrical output
 • 2-wire N/C

EU certification
 • II1G

Configurable product

This product and all its product options can be ordered online via the configurator:

[→ www.festo.com/catalogue/srbg](http://www.festo.com/catalogue/srbg)

Ordering – Basic design

006 Limit switch attachment with plug M12		
005 Electrical output	Type	Part no.
PNP	SRBG-C1-N-1-P-M12	3568055
2-wire N/O contact	SRBG-C1-N-1-ZU-M12	3568056
AS-Interface®	SRBG-C1-N-1-AS-M12-M12	3567908

006 Limit switch attachment with screw terminal		
005 Electrical output	Type	Part no.
PNP	SRBG-C1-N-1-P-C2-C2	3568165
2-wire N/O	SRBG-C1-N-1-ZU-C2-C2	3568166

Accessories

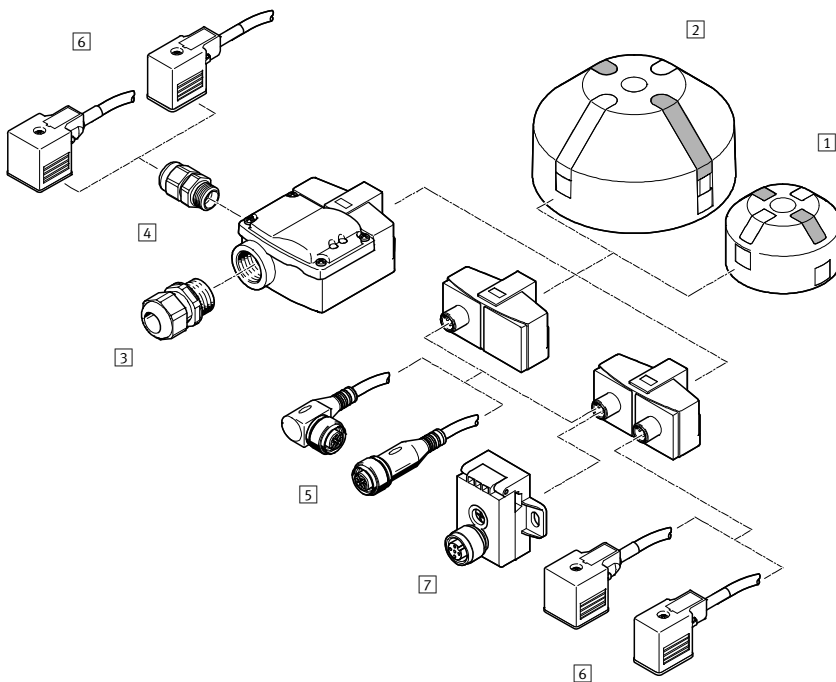

- 1 Position indicator SASF-...-A34 → 333
- 2 Position indicator SASF-...-A56 → 333
- 3 Cable connector NETC-P-M20-... → [srbg](#)
- 4 Cable connector NETC-P-M12-... → [srbg](#)
- 5 Connecting cables NEBU-M12 → 333
- 6 Connecting cables NEBV → [srbg](#)
- 7 AS-Interface components → [srbg](#)

1 / 2 Position indicator SASF

- With 4 actuating elements fixed at an offset of 90°
- Mounting on drive shaft of standard actuators in accordance with VDI/VDE 3845

Description	Type	Part no.
1 Position indicator SASF-... -A34		
Mounting hole 30x80 mm, shaft height 20 mm and 30 mm	SASF-S2-B-F-A34	4046082
2 Position indicator SASF-... -A56		
Mounting hole 30x130 mm, shaft height 30 mm and 50 mm	SASF-S2-B-F-A56	4077125

5 Connecting cable NEBU

Cable length	Connection on right	Type	Part no.
Connection on left: straight socket, M12x1, 5-pin			
2.5 m	Cable, open end, 4-wire	NEBU-M12G5-K-2.5-LE4.5LE4	550326
5 m		NEBU-M12G5-K-5-LE4	541328
Connection on left: angled socket, M12x1, 5-pin			
2.5 m	Cable, open end, 4-wire	NEBU-M12W5-K-2.5-LE4	550325
5 m		NEBU-M12W5-K-5-LE4	541329

Possible combinations of quarter turn actuator and position indicator SASF

Quarter turn actuator	Size	1 SASF-S2-B-F-A34	2 SASF-S2-B-F-A56
Double-acting			
DFPD → 338	10 ... 480	■	-
DAPS → daps	0008 ... 1920	■	-
DAPS → daps	2880 ... 8000	-	■
DAPS-CR → daps	0120 ... 0480	■	-
Single-acting			
DFPD → 338	20 ... 480	■	-
DAPS → daps	0015 ... 0960	■	-
DAPS → daps	1440 ... 4000	-	■
DAPS-CR → daps	0060 ... 0240	■	-

Positioners CMSX



- Positioners for single-acting and double-acting pneumatic quarter turn actuators and double-acting linear actuators in process automation systems
- High process reliability thanks to analogue and digital feedback signals
- Fail-safe or fail-in-place safety function
- Extremely energy-efficient: no internal air consumption at rest
- For automated butterfly valves, ball valves, bulk goods deflectors, etc.

Order code

001 002 003 004 005 006 007 008 009
CMSX - **P** - - **C** - **U** - **F1** - - -

Legend: Mandatory entry

001	Type
CMSX	Positioner, for process automation
002	Product version
P	Primarily polymers
003	Design
S	Positioner, integrated displacement/angle measurement
SE	Positioner, external displacement/angle measurement
004	Display type
C	LCD, backlit
005	Setpoint value
U	Configurable (0 ... 10 V, 0 ... 20 mA, 4 ... 20 mA)
006	Position feedback
F1	4 ... 20 mA

007	Function
D	Double-acting
S	Single-acting
008	Flow rate
50	50 l/min
130	130 l/min
009	Safety function
A	Open or close in the event of a system crash ¹⁾
C	Maintain position in the event of system failure ¹⁾

1) Failure of the operating voltage supply or the setpoint specification.

Ordering

003 Design	007 Function	008 Flow rate	009 Safety function	Type	Part no.
Positioner, integrated displacement/angle detection	Single-acting	50 l/min	Variable opening or closing in the event of system failure ¹⁾	CMSX-P-S-C-U-F1-S-50-A	3929370
	Double-acting	50 l/min		CMSX-P-S-C-U-F1-D-50-A	3929313
Positioner, external displacement/angle detection	Double-acting	130 l/min		CMSX-P-SE-C-U-F1-D-130-A	3929539
		130 l/min		CMSX-P-S-C-U-F1-D-130-A	3929312
Positioner, integrated displacement/angle detection	Single-acting	130 l/min	Hold position in the event of system failure ¹⁾	CMSX-P-S-C-U-F1-S-130-A	3929369
	Double-acting	130 l/min		CMSX-P-S-C-U-F1-D-130-C	3929314
Positioner, external displacement/angle detection		Double-acting		50 l/min	CMSX-P-S-C-U-F1-D-50-C
	130 l/min			CMSX-P-SE-C-U-F1-D-130-C	3929540

1) Failure of the operating voltage supply or the setpoint specification.

Combinations ²⁾ of positioners and actuators			
Positioner CMSX	Quarter turn actuator DFDP → 338	Quarter turn actuator DAPS → daps	Linear actuator DFPI → dfpi
008 Flow rate	Size	Size	Piston Ø
50 l/min	≥160	≥180	–
130 l/min	≥240	≥240	≥100

2) The precise selection of the positioner for the actuator is dependent on the specific application. Please consult your local Festo contact.

Accessories

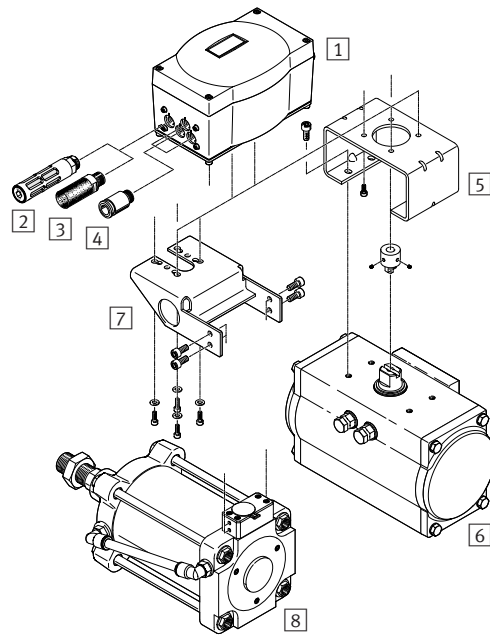
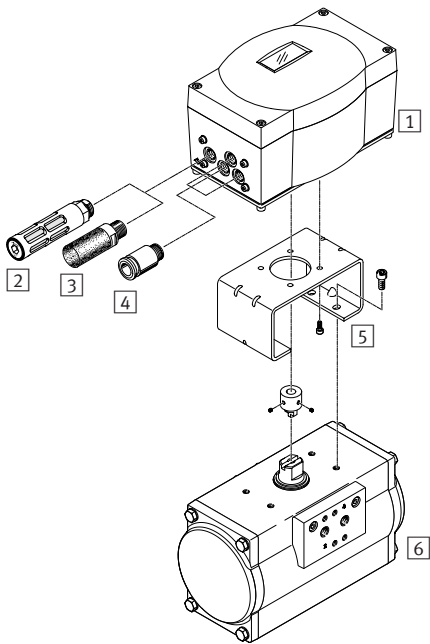

- 1 Positioner CMSX → 334
- 2 Silencer U, polymer, male thread → 317
- 3 Silencer UC, for reducing noise at valve exhaust ports → [uc](#)
- 4 Push-in fitting QS → 293
- 5 Mounting adapter DARQ, for connecting positioners/actuators for process automation → 335
- 6 Quarter turn actuator DFPI → 338
- 7 Adapter kit DADG, for direct mounting of a positioner on the linear actuator DFPI → [dadg](#)
- 8 Linear actuator DFPI → [dfpi](#)

5 Mounting adapter DARQ

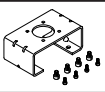
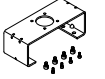
	Size	Type	Part no.
	20	DARQ-K-P-A1-F05-20-R1	2197135
	30	DARQ-K-P-A1-F05-30-R1	2197136

Actuators >

Linear actuators DFPC



- Sturdy tie rod design
- Sizes Ø80, Ø100 and Ø125
- Stroke length 10 ... 1600 mm
- Mounting interface in accordance with ISO 5210 or ISO 15552, with extended tie rods
- Operating pressure 0.6 ... 8 bar
- Ambient temperature -20 ... +80°C
- Selected types in accordance with ATEX directive for potentially explosive atmospheres

→ www.festo.com/ex

Order code

001 002 003 004 005 006 007 008 009 010 011 012
 DFPC - - - D - - - - - - - -

001	Type
DFPC	Linear actuator
002	Piston Ø [mm]
...	80, 100, 125
003	Stroke [mm]
...	50, 65, 80, 100, 125, 150
004	Function
D	Double-acting
005	Piston rod thread type
-	Male thread
006	Housing surface treatment
-	Without
007	EU certification
-	None

008	Piston rod extension
-	Without
009	Piston rod thread extension
-	Without
010	Piston rod thread shortening
-	Without
011	Piston rod thread
-	Standard
012	Thread length of spacer bolts on the bearing cap
-	Without

Legend: Mandatory entry Optional entry

Product options

Piston rod extension
...E 1 ... 500 mm

Piston rod thread shortening
...S 1 ... 30 mm

Piston rod thread
M16, M16x1.5, M20, M20x1.5, M24, M24x1.5

Thread length of spacer bolts on the bearing cap
...LB2 10 ... 120 mm

Piston rod thread extension
...L 0 ... 70 mm

Stroke
... 10 ... 1600 mm

Configurable product

This product and all its product options can be ordered online via the configurator:

→ www.festo.com/catalogue/...

Enter the part number or the type.

Part no.	Type
8110796	DFPC-80-...
8110785	DFPC-100-...
8110797	DFPC-125-...

Ordering

002 Piston Ø [mm]	003 Stroke [mm]	Type	Part no.
Double-acting linear actuator with cushioning at both ends			
80	50	DFPC-80-50-D	8110815
	65	DFPC-80-65-D	8110817
	80	DFPC-80-80-D	8110816
100	80	DFPC-100-80-D	8110777
	100	DFPC-100-100-D	8110776
	125	DFPC-100-125-D	8110775
125	100	DFPC-125-100-D	8110773
	125	DFPC-125-125-D	8110774
	150	DFPC-125-150-D	8110772

Accessories

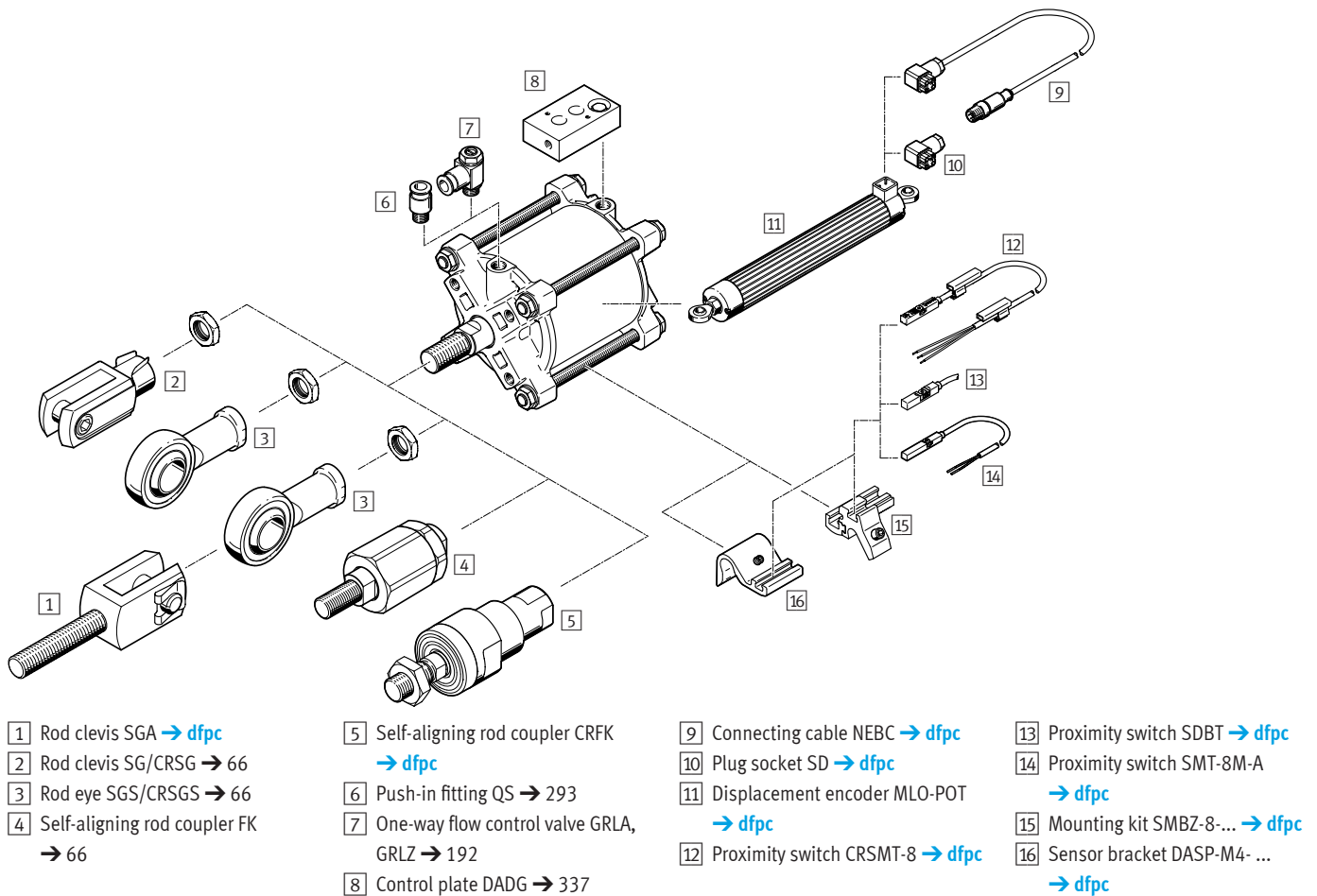

8 Control plate, NAMUR DADG		
Pneumatic connection	Type	Part no.
G1/8	DADG-FM-VDE1G18	8131546
G1/4	DADG-FM-VDE1G14	8131548

Actuators >

Quarter turn actuators DFPD

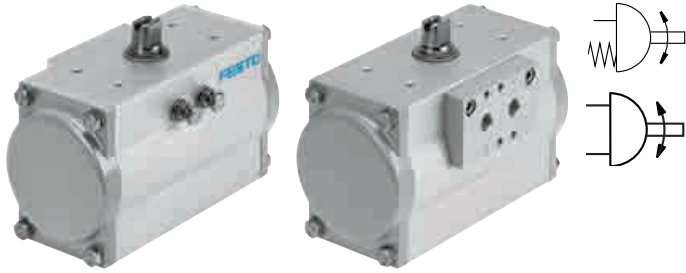

- Size 10 ... 2300
- Torque 10 ... 2200 Nm
- Swivel angle 90°, 120°, 135°, 180°
- Flange hole pattern to ISO 5211
- NAMUR connection pattern for solenoid valves/limit switch attachments to VDI/VDE 3845
- Suitable for the automation of butterfly valves, ball valves and air dampers
- Also suitable for water/wastewater, beverage and pharmaceutical industries as well as process automation

Order code – Basic design

001	002	003	004	005	006	007	008	009	010	011	012	013	014	015	016
DFPD				RP		90	R								

001	Type		
DFPD	Quarter turn actuator		
002	System of units		
–	Metric		
003	Version		
–	Standard		
004	Size	004	Size
10	10	300	300
20	20	480	480
40	40	700	700
80	80	900	900
120	120	1200	1200
160	160	2300	2300
240	240		
005	Design		
RP	Rack and pinion		
006	Yoke type		
–	None		
007	Swivel angle		
90	90°		
008	Swivel direction		
R	To the right		
009	Function		
D	Double-acting		
S	Single-acting		

010	Spring configuration
–	Without
60	For connection pressure 6 bar
011	Flange pattern 1
F03	Hole pattern F03
F04	Hole pattern F04
F05	Hole pattern F05
F07	Hole pattern F07
F10	Hole pattern F10
F12	Hole pattern F12
F14	Hole pattern F14
012	Flange pattern 2
–	None
07	Hole pattern F07
10	Hole pattern F10
12	Hole pattern F12
16	Hole pattern F16
013	Manual override
–	None
014	Temperature range
–	Standard
015	Shaft material
–	Standard
016	Housing surface treatment
–	None

Legend: Mandatory entry Optional entry

Product options

System of units

- Imperial

Swivel angle

- 0 ... 180°

Swivel direction

- To the left

Spring configuration

- For connection pressure 2 ... 5.5 bar

Temperature range

- 0 ... +150° C
- –50 ... +60° C

Shaft material

- Stainless steel

Housing surface treatment

- Epoxy-coated

DFPD-C

- Version for use in chemical and petrochemical plants

Ordering – Product options

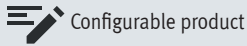

Configurable product

This product and all its product options can be ordered online via the configurator:

→ www.festo.com/catalogue/dfpd

Ordering – Basic design

004 Size	Type	Part no.
009 Quarter turn actuators DFPD, single-acting		
10	–	
20	DFPD-20-RP-90-RS60-F04	8047622
	DFPD-20-RP-90-RS60-F05	8048015
40	DFPD-40-RP-90-RS60-F0507	8047624
80	DFPD-80-RP-90-RS60-F0507	8047626
120	DFPD-120-RP-90-RS60-F0507	8048134
160	DFPD-160-RP-90-RS60-F0710	8048136
240	DFPD-240-RP-90-RS60-F0710	8048138
300	DFPD-300-RP-90-RS60-F0710	8048140
480	DFPD-480-RP-90-RS60-F1012	8048142
700	DFPD-700-RP-90-RS60-F1012	8065262
900	DFPD-900-RP-90-RS60-F14	8065266
1200	DFPD-1200-RP-90-RS60-F14	8065270
2300	DFPD-2300-RP-90-RS60-F1216	8065274

004 Size	Type	Part no.
009 Quarter turn actuators DFPD, double-acting		
10	DFPD-10-RP-90-RD-F03	8047613
	DFPD-10-RP-90-RD-F04	8048010
20	DFPD-20-RP-90-RD-F04	8047614
40	DFPD-40-RP-90-RD-F0507	8047615
80	DFPD-80-RP-90-RD-F0507	8047616
120	DFPD-120-RP-90-RD-F0507	8048123
160	DFPD-160-RP-90-RD-F0710	8048124
240	DFPD-240-RP-90-RD-F0710	8048125
300	DFPD-300-RP-90-RD-F0710	8048126
480	DFPD-480-RP-90-RD-F1012	8048127
700	DFPD-700-RP-90-RD-F1012	8065261
900	DFPD-900-RP-90-RD-F14	8065265
1200	DFPD-1200-RP-90-RD-F14	8065269
2300	DFPD-2300-RP-90-RD-F1216	8065273

Accessories

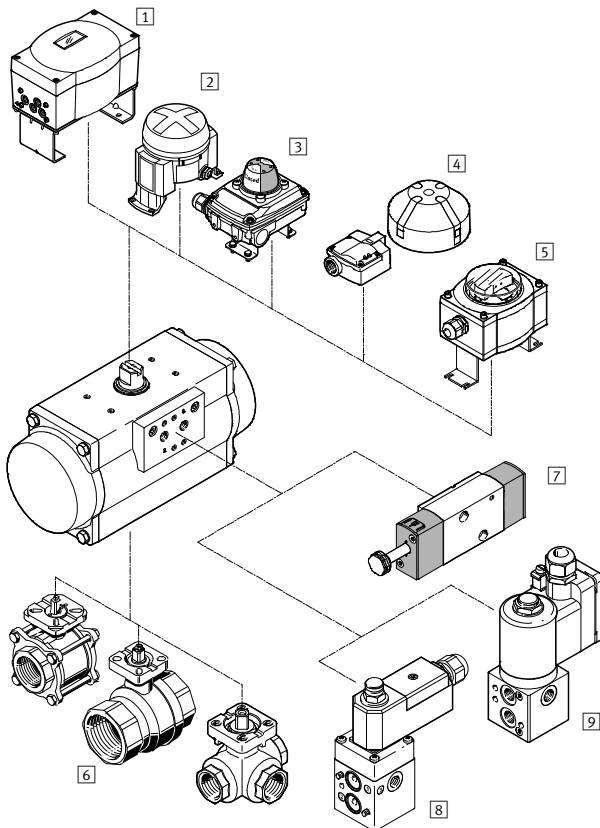

- 1 Positioner CMSX → 334
- 2 Limit switch attachment DAPZ → [dapz](#)
- 3 Limit switch attachment SRBC → 330
- 4 Limit switch attachment SRBG with position indicator SASF → 332
- 5 Limit switch attachment SRAP → [srap](#)
- 6 Ball valve VAPB → [vapb](#)
Ball valve VZBA → 340
- 7 Solenoid valve VSNC → 157
- 8 Solenoid valve VOFC → [vofc](#)
- 9 Solenoid valve VOFD → [vofd](#)

Process valves >

Ball valves VZBA

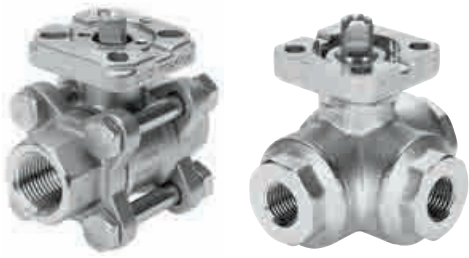

- Stainless steel design
- 2/2-way, with pipe thread to EN 10226-1
- 2/2-way, with weld-on ends to EN 12627
- 3/2-way, L-shaped hole with pipe thread to EN 10226-1
- 3/2-way, T-shaped hole with pipe thread to EN 10226-1
- Connecting thread Rp1/4 ... Rp4
- Flow rate 4.5 ... 1414 m³/h

Order code

001 002 003 004 005 006 007 008 009 010 011 012 013 014
 VZBA - [] - [] - [] - [] - 63 - [] - [] - [] - [] V4 V4 T

001	Type
VZBA	Ball valve
002	Nominal width DN
1/4"	DN8
3/8"	DN10
1/2"	DN15
3/4"	DN20
1"	DN25
1 1/4"	DN32
1 1/2"	DN40
2"	DN50
2 1/2"	DN65
3"	DN80
4"	DN100
003	Process valve connection type 1
G	Pipe thread to DIN EN 10226-1
W	Welded end
004	Process valve connection type 2
G	Pipe thread to DIN EN 10226-1
W	Welded end
005	Process valve connection type 3
-	Without
G	Pipe thread to DIN EN 10226-1
006	Nominal pressure PN of process valve
63	63 bar

007	Design
-	Standard
T	Three-part
008	Overall length
-	Standard
009	Valve function
32L	3/2-way, L-shaped hole
32T	3/2-way, T-shaped hole
22	2/2-way
010	Flanged connection
F10	Hole pattern 10
F0304	Hole pattern 03 and 04
F0405	Hole pattern 04 and 05
F0507	Hole pattern 05 and 07
F0710	Hole pattern 07 and 10
011	Actuation type
-	Via actuator
012	Housing material
V4	Stainless steel
013	Shut-off element material
V4	Stainless steel
014	Sealing element material
T	PTFE-reinforced

Legend: [] Mandatory entry [] Optional entry

Ordering – VZBA, 2/2-way

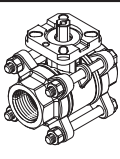
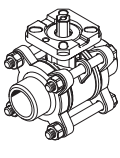
	Version	Process valve connection	Type	Part no.
	– With pipe thread	Rp1/4	VZBA-1/4"-GG-63-T-22-F0304-V4V4T	1686625
		Rp3/8	VZBA-3/8"-GG-63-T-22-F0304-V4V4T	1686632
		Rp1/2	VZBA-1/2"-GG-63-T-22-F0304-V4V4T	1686636
		Rp3/4	VZBA-3/4"-GG-63-T-22-F0304-V4V4T	1686639
		Rp1	VZBA-1"-GG-63-T-22-F0405-V4V4T	1686640
		Rp1 1/4	VZBA-1 1/4"-GG-63-T-22-F0405-V4V4T	1686641
		Rp1 1/2	VZBA-1 1/2"-GG-63-T-22-F0507-V4V4T	1686643
		Rp2	VZBA-2"-GG-63-T-22-F0507-V4V4T	1686646
		Rp2 1/2	VZBA-2 1/2"-GG-63-T-22-F0710-V4V4T	1686648
		Rp3	VZBA-3"-GG-63-T-22-F0710-V4V4T	1686651
		Rp4	VZBA-4"-GG-63-T-22-F10-V4V4T	1686654
	– With weld-on ends	Weld-on end	VZBA-1/4"-WW-63-T-22-F0304-V4V4T	1686656
			VZBA-3/8"-WW-63-T-22-F0304-V4V4T	1686662
			VZBA-1/2"-WW-63-T-22-F0304-V4V4T	1686663
			VZBA-3/4"-WW-63-T-22-F0304-V4V4T	1686665
			VZBA-1"-WW-63-T-22-F0405-V4V4T	1686689
			VZBA-1 1/4"-WW-63-T-22-F0405-V4V4T	1686696
			VZBA-1 1/2"-WW-63-T-22-F0507-V4V4T	1686697
			VZBA-2"-WW-63-T-22-F0507-V4V4T	1686699
			VZBA-2 1/2"-WW-63-T-22-F0710-V4V4T	1686702
			VZBA-3"-WW-63-T-22-F0710-V4V4T	1686704
			VZBA-4"-WW-63-T-22-F10-V4V4T	1686705

Ordering – VZBA, 3/2-way

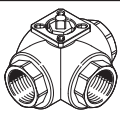
	Version	Connecting thread	Type	Part no.
	– With pipe thread – L-shaped hole	Rp1/4	VZBA-1/4"-GGG-63-32L-F0304-V4V4T	1692210
		Rp3/8	VZBA-3/8"-GGG-63-32L-F0304-V4V4T	1692211
		Rp1/2	VZBA-1/2"-GGG-63-32L-F0304-V4V4T	1692212
		Rp3/4	VZBA-3/4"-GGG-63-32L-F0405-V4V4T	1692214
		Rp1	VZBA-1"-GGG-63-32L-F0405-V4V4T	1692215
		Rp1 1/4	VZBA-1 1/4"-GGG-63-32L-F0405-V4V4T	1692217
		Rp1 1/2	VZBA-1 1/2"-GGG-63-32L-F0405-V4V4T	1692218
		Rp2	VZBA-2"-GGG-63-32L-F0507-V4V4T	1692219
		– With pipe thread – T-shaped hole	Rp1/4	VZBA-1/4"-GGG-63-32T-F0304-V4V4T
	Rp3/8		VZBA-3/8"-GGG-63-32T-F0304-V4V4T	1692221
	Rp1/2		VZBA-1/2"-GGG-63-32T-F0304-V4V4T	1692224
	Rp3/4		VZBA-3/4"-GGG-63-32T-F0405-V4V4T	1692226
	Rp1		VZBA-1"-GGG-63-32T-F0405-V4V4T	1692227
	Rp1 1/4		VZBA-1 1/4"-GGG-63-32T-F0405-V4V4T	1692228
	Rp1 1/2		VZBA-1 1/2"-GGG-63-32T-F0405-V4V4T	1692229
	Rp2		VZBA-2"-GGG-63-32T-F0507-V4V4T	1692230

Accessories

Hand lever VAOH → [vzba](#)Mounting kit DARQ-K → [vzba](#)Mounting adapter DARQ-B → [vzba](#)Reducing sleeve DARQ-R → [vzba](#)

Process valves >

Angle seat valves VZXA



- Suitable for virtually all media
- High chemical and thermal resistance
- Modular design
- Hygienic design, insensitive to dirt
- Long service life
- Quick and easy maintenance
- High flow rates achievable
- Selected types in accordance with ATEX directive for potentially explosive atmospheres

→ www.festo.com/ex

Order code – Basic design

001 002 003 004 005 006 007 008 009 010 011 012 013 014 015 016 017
VZXA - - - - **T** - - - **M2** - - - **T** - - **K** - - - - - - - **V4** -

001	Type		
VZXA	Process valve		
002	Flow direction		
A	Over valve seat, for gaseous media		
B	Under valve seat, for gaseous and liquid media		
003	Control of the medium		
-	On/off operation		
004	Cable connection		
T	Threaded collar		
005	Connection standard		
S6	DIN ISO 228-1		
S7	ANSI/ASME B 1.20.1		
006	Connection size	006	Connection size
1/2"	1/2"	13	DN13
3/4"	3/4"	20	DN20
1"	1"	25	DN25
007	Temperature of medium		
M2	-10 ... +180°C		
008	Valve housing material		
V13	Stainless steel 1.4409		
V14	Stainless steel ASTM A351-CF3M		
009	Seat seal material		
T	PTFE		

010	Medium pressure
8.3	0 ... 8.3 bar
12.8	0 ... 12.8 bar
23	0 ... 23 bar
30	0 ... 30 bar
011	Actuator
K	Piston actuator
012	Actuator size
46	46 mm
75	75 mm
013	Stroke
17	17 mm
20	20 mm
014	Control function
-	Closed via spring force, NC
015	Position sensing
-	Via mechanical indicator
016	Actuator housing material
V4	Stainless steel 1.4408
017	EU certification
-	None

Legend: Mandatory entry Optional entry

Product options

Connection standard

- DIN 10226-2
- DN32, DN40, DN50
- 1 1/2", 1 1/4", 2"

Medium pressure

- 4 ... 25 bar

Actuator

- Diaphragm actuator

Actuator size

- 90 mm

Stroke

- 26 mm

EU certification

- II 2GD

Ordering – Product options

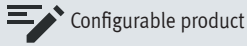

Configurable product

This product and all its product options can be ordered online via the configurator:

→ www.festo.com/catalogue/...

Enter the part number or the type.

Part no. Type
3539410 VZXA

Ordering – Basic design

006 Connection size	Type	Part no.	006 Connection size	Type	Part no.
012 Actuator size 46 mm					
005 Connection standard DIN ISO 228-1			005 Connection standard ANSI/ASME B 1.20.1		
DN13	VZXA-B-TS6-13-M2-V13T-30-K-46-17-V4	8060527	1/2"	VZXA-B-TS7-1/2"-M2-V14T-30-K-46-17-V4	8060541
DN20	VZXA-B-TS6-20-M2-V13T-12.8-K-46-17-V4	8060528	3/4"	VZXA-B-TS7-3/4"-M2-V14T-12.8-K-46-17-V4	8060542
DN25	VZXA-B-TS6-25-M2-V13T-8.3-K-46-17-V4	8060530	1"	VZXA-B-TS7-1"-M2-V14T-8.3-K-46-17-V4	8060544
012 Actuator size 75 mm					
005 Connection standard DIN ISO 228-1			005 Connection standard ANSI/ASME B 1.20.1		
DN20	VZXA-B-TS6-20-M2-V13T-30-K-75-20-V4	8060529	3/4"	VZXA-B-TS7-3/4"-M2-V14T-30-K-75-20-V4	8060543
DN25	VZXA-B-TS6-25-M2-V13T-23-K-75-20-V4	8060531	1"	VZXA-B-TS7-1"-M2-V14T-23-K-75-20-V4	8060545

Accessories

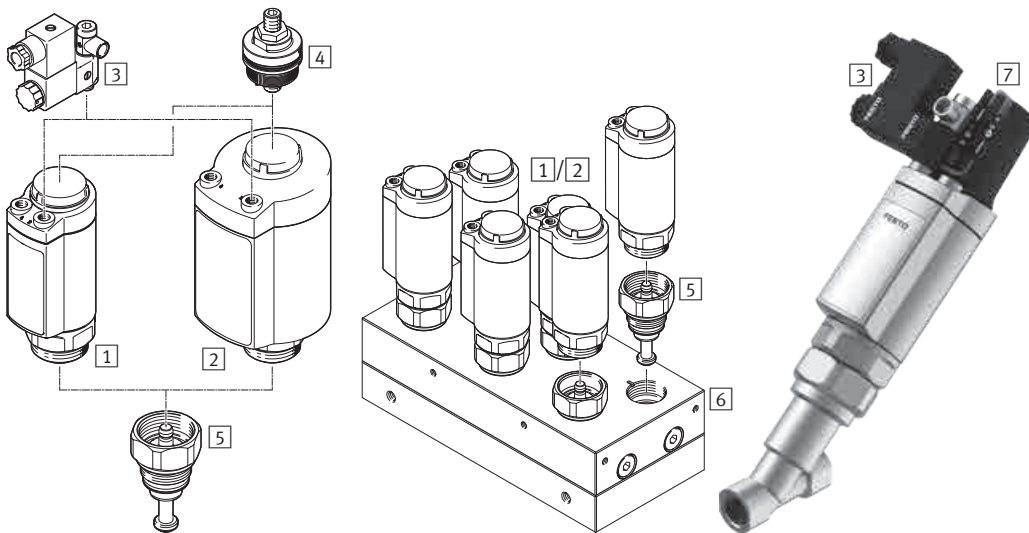

- 1 Piston drive DFPK, drive size 46 mm → [vzxa](#)
- 2 Piston drive DFPK, drive size 75 mm → [vzxa](#)
- 3 Pilot valve VOFX → 343
- 4 Stroke reduction VAVA → 343
- 5 Cover kit VAVC → [vzxa](#)
- 6 Manifold block → [vzxa](#)
- 7 Position indicator SAMH → 343

3 Pilot valve VOFX		
Description	Type	Part no.
3/2-way, single solenoid, closed	VOFX-LT-M32C-MY-G18-SG18-1B2	8119587

4 Stroke reduction VAVA		
Description	Type	Part no.
Opening stroke limitation		
Stop with adjustable threaded pin, only for flow beneath the seat	VAVA-F12-H-H1	8089993
Stop with adjustable shock absorb	VAVA-F12-H-H6	8107369

7 Position indicator SAMH		
Description	Type	Part no.
Without sensors	SAMH-F12-MK	8092711
2 proximity switches with explosion protection	SAMH-F12-MK-A1	8092712
2 proximity switches with explosion protection and high level of IP protection	SAMH-F12-MK-A2	8101084

Process valves >

Pinch valves VZQA



- Housing made of aluminium, stainless steel (clean design)
 - Shut-off element material EPDM, NBR, silicone
 - For controlling fluid/powdery media, solids and mixtures of substances
 - Selected types in accordance with ATEX directive for potentially explosive atmospheres
- www.festo.com/ex

Order code – Basic design

001 002 003 004 005 006 007 008 009 010 011

VZQA - C - [] - [] - [] [] - [] [] [] - [] - []

001	Type
VZQA	Pinch valve, pneumatically actuated
002	Product version
C	Easy-to-clean design
003	Valve function
M22C	2/2-way valve, normally closed
M22U	2/2-way valve, normally open
004	Nominal diameter DN
6	6 mm
15	15 mm
25	25 mm
005	Process valve connection type 1
G	G female thread
S5	Clamp ferrule to DIN 32676, series A
006	Process valve connection type 2
G	G female thread
S5	Clamp ferrule to DIN 32676, series A

007	Housing material
AL	Aluminium
V2	Stainless steel (chrome-nickel, austenitic)
V4	Stainless steel (chrome-nickel-molybdenum, austenitic)
008	Housing cover material
AL	Aluminium
V4	Stainless steel (chrome-nickel-molybdenum, austenitic)
POM	Polyoxymethylene
009	Shut-off element material
E	EPDM
N	NBR
S1	Silicone
010	Pressure range of media
2	0 ... 2 bar
4	0 ... 4 bar
011	Sensing type
-	None

Legend: Mandatory entry Optional entry

Product options

Process valve connection

- NPT female thread
- Clamp ferrule to ASME-BPE, type A

• Clamp ferrule to ASME-BPE, type B

Pressure range

- 0 ... 6 bar

Sensing type

- End position

Configurable product

This product and all its product options can be ordered online via the configurator:

→ www.festo.com/catalogue/...

Enter the part number or the type.

Part no.	Type	003 Valve function	004 Nominal diameter DN	010 Pressure range of media
2037881	VZQA-C-M22U-4	2/2-way valve, normally open	Selectable	0 ... 4 bar
3174282	VZQA-C-M22C-15-6	2/2-way valve, normally closed	15 mm	0 ... 6 bar

Ordering – Basic design

003 Valve function	004 Nominal diameter DN	005 Process valve connection	009 Shut-off element material	Type	Part no.
010 Pressure range of media: 0 ... 2 bar					
2/2-way valve, normally closed	6	Clamp ferrule to DIN 32676, series A	Silicone	VZQA-C-M22C-6-S5S5-V2V4S1-2	8117022
	15	Clamp ferrule to DIN 32676, series A	Silicone	VZQA-C-M22C-15-S5S5-V2V4S1-2	3412427
	6	G female thread G1/4	Silicone	VZQA-C-M22C-6-GG-V2V4S1-2	8117024
	15	G female thread G1/2	Silicone	VZQA-C-M22C-15-GG-V2V4S1-2	3412428
010 Pressure range of media: 0 ... 4 bar					
2/2-way valve, normally open	6	Clamp ferrule to DIN 32676, series A	EPDM	VZQA-C-M22U-6-S5S5-V4V4E-4	2931681
	6	Clamp ferrule to DIN 32676, series A	Silicone	VZQA-C-M22U-6-S5S5-V4V4S1-4	2931682
	15	Clamp ferrule to DIN 32676, series A	EPDM	VZQA-C-M22U-15-S5S5-V4V4E-4	3022833
	15	Clamp ferrule to DIN 32676, series A	Silicone	VZQA-C-M22U-15-S5S5-V4V4S1-4	3022834
	25	Clamp ferrule to DIN 32676, series A	EPDM	VZQA-C-M22U-25-S5S5-V4V4E-4	3968924
	25	Clamp ferrule to DIN 32676, series A	Silicone	VZQA-C-M22U-25-S5S5-V4V4S1-4	3968925
2/2-way valve, normally open	6	G female thread G1/4	EPDM	VZQA-C-M22U-6-GG-V4V4E-4	2931678
	6	G female thread G1/4	NBR	VZQA-C-M22U-6-GG-ALV4N-4	2931679
	6	G female thread G1/4	Silicone	VZQA-C-M22U-6-GG-V4V4S1-4	2931683
	15	G female thread G1/2	EPDM	VZQA-C-M22U-15-GG-V4V4E-4	3022829
	15	G female thread G1/2	NBR	VZQA-C-M22U-15-GG-V4V4N-4	3022830
	15	G female thread G1/2	Silicone	VZQA-C-M22U-15-GG-V4V4S1-4	3022835
	15	G female thread G1/2	NBR	VZQA-C-M22U-15-GG-ALV4N-4	3022831
	15	G female thread G1/2	NBR	VZQA-C-M22U-15-GG-ALPOMN-4	3022832
	25	G female thread G1	EPDM	VZQA-C-M22U-25-GG-V4V4E-4	3968922
	25	G female thread G1	EPDM	VZQA-C-M22U-25-GG-ALALE-4	3968923
	25	G female thread G1	Silicone	VZQA-C-M22U-25-GG-V4V4S1-4	3968926

Accessories

Seal cartridge VAVC-Q2

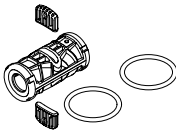
	For valve function	Nominal diameter DN	Shut-off element material	Type	Part no.
	2/2-way valve, normally open	6	NBR	VAVC-Q2-M22U-6-N	2392881
			EPDM	VAVC-Q2-M22U-6-E	2392882
			VMQ (silicone)	VAVC-Q2-M22U-6-S1	2392883
		15	VMQ (silicone)	VAVC-Q2-M22U-15-S1	3019144
			EPDM	VAVC-Q2-M22U-15-E	3019148
			NBR	VAVC-Q2-M22U-15-N	3019151
		25	NBR	VAVC-Q2-M22U-25-N	3970092
			EPDM	VAVC-Q2-M22U-25-E	3970093
			VMQ (silicone)	VAVC-Q2-M22U-25-S1	3970094
	2/2-way valve, normally closed	6	EPDM	VAVC-Q2-M22C-6-E	3418620
15		EPDM	VAVC-Q2-M22C-15-E	3418619	

Proximity switch, N/O, magneto-resistive SMT-8M

Description	Type	Part no.
PNP, short design		
Cable, 3-core, 2.5 m	SMT-8M-A-PS-24V-E-2,5-OE	574335
Plug M8x1, 3-pin, 0.3 m	SMT-8M-A-PS-24V-E-0,3-M8D	574334
NPN, short design		
Cable, 3-core, 2.5 m	SMT-8M-A-NS-24V-E-2,5-OE	574338
Plug M8x1, 3-pin, 0.3 m	SMT-8M-A-NS-24V-E-0,3-M8D	574339

Proximity switch, N/C, magneto-resistive SMT-8M

Description	Type	Part no.
PNP, short design		
Cable, 3-wire, 7.5 m	SMT-8M-A-PO-24V-E-7,5-OE	574340

Process valves >

Solenoid valves VZWD, directly actuated

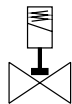

- Suitable for applications with high pressure and low flow rates
- Operating pressure 0 ... 90 bar
- Process valve PN 50 nominal pressure
- Flow rate Kv 0.06 ... 0.4 m³/h
- Solenoid actuation

Order code – Basic design

001 002 003 004 005 006 007 008 009 010 011
VZWD - **L** - **M22C** - **M** - - - **V** - **1** **P4** - -

001	Type
VZWD	Solenoid valve, directly actuated

002	Type of directional control valve
L	In-line valve

003	Valve function
M22C	2/2-way valve, normally closed, mechanical reset

004	Reset method
M	Mechanical spring

005	Process valve connection
G18	G1/8 thread
G14	G1/4 thread

006	Nominal width DN		
10	1 mm	40	4 mm
20	2 mm	60	6 mm
30	3 mm		

007	Sealing element material
V	FPM

008	Nominal operating voltage
1	24 V DC

009	Electrical connection
P4	Plug socket, 3-pin

010	Medium pressure
4	Max. 4 bar
8	Max. 8 bar
15	Max. 15 bar
50	Max. 50 bar

011	Corrosion protection
-	Brass
R1	Stainless steel

Legend: Mandatory entry Optional entry

Product options

Nominal size

- 1.5 mm
- 2.5 mm
- 5 mm

Nominal operating voltage

- 110 V AC /50-60 Hz
- 230 V AC /50-60 Hz

Medium pressure

- 5 ... max. 90 bar

Configurable product

This product and all its product options can be ordered online via the configurator:

→ www.festo.com/catalogue/vzwd

Ordering – Basic design

005 Process valve connection	006 Nominal width DN	010 Medium pressure ¹⁾	Type	Part no.
008 Nominal operating voltage 24 V DC				
011 Corrosion protection: brass				
G1/8	1 mm	0 ... 50 bar	VZWD-L-M22C-M-G18-10-V-1P4-50	1491825
	2 mm	0 ... 15 bar	VZWD-L-M22C-M-G18-20-V-1P4-15	1491827
	3 mm	0 ... 15 bar	VZWD-L-M22C-M-G18-30-V-1P4-15	1491836
	4 mm	0 ... 8 bar	VZWD-L-M22C-M-G18-40-V-1P4-8	1491837
G1/4	3 mm	0 ... 15 bar	VZWD-L-M22C-M-G14-30-V-1P4-15	1491844
	4 mm	0 ... 8 bar	VZWD-L-M22C-M-G14-40-V-1P4-8	1491845
	6 mm	0 ... 4 bar	VZWD-L-M22C-M-G14-60-V-1P4-4	1491847
011 Corrosion protection: stainless steel				
G1/8	3 mm	0 ... 15 bar	VZWD-L-M22C-M-G18-30-V-1P4-15-R1	1491852
	4 mm	0 ... 8 bar	VZWD-L-M22C-M-G18-40-V-1P4-8-R1	1491853
G1/4	3 mm	0 ... 15 bar	VZWD-L-M22C-M-G14-30-V-1P4-15-R1	1491860
	4 mm	0 ... 8 bar	VZWD-L-M22C-M-G14-40-V-1P4-8-R1	1491861
	6 mm	0 ... 4 bar	VZWD-L-M22C-M-G14-60-V-1P4-4-R1	1491863

1) The valves are suitable for vacuum with Pabs > 100 mbar. Please ensure the direction of flow corresponds to the direction of the arrow.

Process valves >

Solenoid valves VZWF, force pilot operated



- Suitable for closed applications such as cooling or filling systems
- For control of gaseous and liquid media
- Medium pressure 0 bar or higher
- Process valve PN 40 nominal pressure
- Solenoid actuation

Order code – Basic design

001 002 003 004 005 006 007 008 009 010 011
VZWF - **B** - **L** - **M22C** - - - - **1** **P4** - -

001	Type		
VZWF	Solenoid valve, force pilot operated		
002	Product version		
B	Optimised function		
003	Valve type		
L	In-line valve		
004	Valve function		
M22C	2/2-way valve, normally closed		
005	Process valve connection		
G14	G1/4 thread	G34	G3/4 thread
G38	G3/8 thread	G1	Thread G1
G12	G1/2 thread		
006	Nominal width DN		
135	13.5 mm		
275	27.5 mm		

007	Sealing element material		
-	Standard (NBR)		
E	EPDM		
008	Nominal operating voltage		
1	24 V DC		
009	Electrical connection		
P4	Plug socket, 3-pin		
010	Medium pressure		
6	Max. 6 bar		
10	Max. 10 bar		
011	Corrosion protection		
-	Standard (brass)		
R1	Stainless steel		

Legend: Mandatory entry Optional entry

Product options

Product version

- Standard

Process valve connection

- G1, G1¼, G1½, G2

Nominal width DN

- 40 mm
- 50 mm

Nominal operating voltage

- 110 V AC/50-60Hz
- 230 V AC/50-60Hz

Configurable product

This product and all its product options can be ordered online via the configurator:

→ www.festo.com/catalogue/vzwf

Ordering – Basic design

005 Process valve connection	006 Nominal width DN	010 Medium pressure	Type	Part no.
008 Nominal operating voltage 24 V DC				
007 Seal material NBR, 011 Standard corrosion protection (brass)				
G1/4	13.5 mm	0 ... 10 bar	VZWF-B-L-M22C-G14-135-1P4-10	1492110
G3/8	13.5 mm	0 ... 10 bar	VZWF-B-L-M22C-G38-135-1P4-10	1492111
G1/2	13.5 mm	0 ... 10 bar	VZWF-B-L-M22C-G12-135-1P4-10	1492112
G3/4	27.5 mm	0 ... 6 bar	VZWF-B-L-M22C-G34-275-1P4-6	1492113
G1	27.5 mm	0 ... 6 bar	VZWF-B-L-M22C-G1-275-1P4-6	1492114
007 Sealing element material EPDM, 011 Stainless steel corrosion protection				
G1/4	13.5 mm	0 ... 10 bar	VZWF-B-L-M22C-G14-135-E-1P4-10-R1	1492134
G3/8	13.5 mm	0 ... 10 bar	VZWF-B-L-M22C-G38-135-E-1P4-10-R1	1492135
G1/2	13.5 mm	0 ... 10 bar	VZWF-B-L-M22C-G12-135-E-1P4-10-R1	1492136
G3/4	27.5 mm	0 ... 6 bar	VZWF-B-L-M22C-G34-275-E-1P4-6-R1	1492137
G1	27.5 mm	0 ... 6 bar	VZWF-B-L-M22C-G1-275-E-1P4-6-R1	1492138

Process valves >

Solenoid valves VZWM

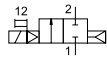

- Indirectly actuated poppet valve with diaphragm seal
- Flow rate 1400 ... 31000 l/min
- Wide range of coils

Order code – Basic design

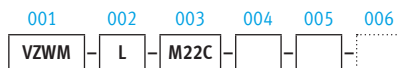

Legend: Mandatory entry Optional entry

001	Type		
VZWM	Solenoid valve, process directional control valve		
002	Valve type		
L	In-line valve		
003	Valve function		
M22C	2/2-way valve, normally closed		
004	Process valve connection		
G14	G1/4 thread	G34	G3/4 thread
G38	G3/8 thread	G1	Thread G1
G12	G1/2 thread		

005	Electrical connection
F4	With armature tube for solenoid coil MD-2- ... -PA
F5	With armature tube for solenoid coil MH-2- ... -PA
006	Corrosion protection
-	Standard (brass)
R1	Stainless steel

Product options

Process valve connection

- G1¼, G1½, G2

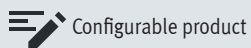

Configurable product

This product and all its product options can be ordered online via the configurator:

→ www.festo.com/catalogue/vzwm

Ordering – Basic design

004 Process valve connection	Type	Part no.
	006 Standard corrosion protection (brass)	
G1/4	VZWM-L-M22C-G14-F4	546146
G3/8	VZWM-L-M22C-G38-F4	546147
G1/2	VZWM-L-M22C-G12-F4	546148
G3/4	VZWM-L-M22C-G34-F4	546149
G1	VZWM-L-M22C-G1-F4	546150

004 Process valve connection	Type	Part no.
	006 Stainless steel corrosion protection	
G1/4	VZWM-L-M22C-G14-F5-R1	546162
G3/8	VZWM-L-M22C-G38-F5-R1	546163
G1/2	VZWM-L-M22C-G12-F5-R1	546164
G3/4	VZWM-L-M22C-G34-F5-R1	546165
G1	VZWM-L-M22C-G1-F5-R1	546166

Accessories

Solenoid coil MD		
Voltage	Type	Part no.
Solenoid coil for VZWM- ... -F4- ...		
24 V DC	MD-2-24VDC-PA	549903

Solenoid coil MH		
Voltage	Type	Part no.
Solenoid coil for VZWM- ... -F5- ...		
24 V DC	MH-2-24VDC-PA	549906
110 V AC, 50 ... 60 Hz	MH-2-110VAC-PA	549907
230 V AC, 50 ... 60 Hz	MH-2-230VAC-PA	549908

Plug socket MSSD		
Electrical connection	Type	Part no.
3-pin, square design MSF	MSSD-N	550067

Process valve units >

Ball valve actuator units VZBM



- Pneumatic actuation
- Ball valve actuator unit with double-acting or single-acting quarter turn actuator
- Brass design
- Pipe thread to EN 10226-1
- Flange hole pattern to ISO 5211
- Flow is fully opened or closed in both directions
- Limit switch attachments or limit switches can be mounted directly on the actuator unit for sensing the end positions

Order code

001 002 003 004 005 006 007 008 009 010
VZBM - **A** - - **RP** - - - - **B2** -

Legend: Mandatory entry

001	Type
VZBM	Ball valve

002	Design
A	Ball valve actuator unit

003	Nominal width DN
1/4"	DN8
3/8"	DN10
1/2"	DN15
3/4"	DN20
1"	DN25
1 1/4"	DN32
1 1/2"	DN40
2"	DN50

004	Process valve connection type
RP	Rp thread

005	Nominal pressure
25	25 bar
40	40 bar

006	Design
D	Two-part
F	Four-part

007	Valve function
2	2/2 way
3L	3/2-way, L-shaped hole
3T	3/2-way, T-shaped hole

008	Housing material
B2	Brass, nickel-plated

009	Design
PA	Quarter turn actuator DFPD, double-acting
PB	Quarter turn actuator DFPD, single-acting

010	Size
10	10
20	20
40	40
80	80
120	120

Ordering

007 Valve function	003 Nominal width DN	Connecting thread	Type	Part no.	Type	Part no.
			009 Quarter turn actuators DFPD, single-acting	009 Quarter turn actuators DFPD, double-acting		
2/2 way	8	Rp1/4	VZBM-A-1/4"-RP-40-D-2-B2-PB20	8070242	VZBM-A-1/4"-RP-40-D-2-B2-PA10	8070234
	10	Rp3/8	VZBM-A-3/8"-RP-40-D-2-B2-PB20	8070243	VZBM-A-3/8"-RP-40-D-2-B2-PA10	8070235
	15	Rp1/2	VZBM-A-1/2"-RP-25-D-2-B2-PB20	8070244	VZBM-A-1/2"-RP-25-D-2-B2-PA10	8070236
	20	Rp3/4	VZBM-A-3/4"-RP-25-D-2-B2-PB20	8070245	VZBM-A-3/4"-RP-25-D-2-B2-PA10	8070237
	25	Rp1	VZBM-A-1"-RP-25-D-2-B2-PB20	8070246	VZBM-A-1"-RP-25-D-2-B2-PA10	8070238
	32	Rp1 1/4	VZBM-A-1 1/4"-RP-25-D-2-B2-PB20	8070247	VZBM-A-1 1/4"-RP-25-D-2-B2-PA10	8070239
	40	Rp1 1/2	VZBM-A-1 1/2"-RP-25-D-2-B2-PB40	8070248	VZBM-A-1 1/2"-RP-25-D-2-B2-PA20	8070240
	50	Rp2	VZBM-A-2"-RP-25-D-2-B2-PB80	8070249	VZBM-A-2"-RP-25-D-2-B2-PA40	8070241
3/2-way, L-shaped hole	8	Rp1/4	VZBM-A-1/4"-RP-25-F-3L-B2-PB20	8070266	VZBM-A-1/4"-RP-25-F-3L-B2-PA10	8070250
	10	Rp3/8	VZBM-A-3/8"-RP-25-F-3L-B2-PB20	8070267	VZBM-A-3/8"-RP-25-F-3L-B2-PA10	8070251
	15	Rp1/2	VZBM-A-1/2"-RP-25-F-3L-B2-PB20	8070268	VZBM-A-1/2"-RP-25-F-3L-B2-PA10	8070252
	20	Rp3/4	VZBM-A-3/4"-RP-25-F-3L-B2-PB40	8070269	VZBM-A-3/4"-RP-25-F-3L-B2-PA20	8070253
	25	Rp1	VZBM-A-1"-RP-25-F-3L-B2-PB40	8070270	VZBM-A-1"-RP-25-F-3L-B2-PA20	8070254
	32	Rp1 1/4	VZBM-A-1 1/4"-RP-25-F-3L-B2-PB80	8070271	VZBM-A-1 1/4"-RP-25-F-3L-B2-PA40	8070255
	40	Rp1 1/2	VZBM-A-1 1/2"-RP-25-F-3L-B2-PB120	8070272	VZBM-A-1 1/2"-RP-25-F-3L-B2-PA80	8070256
	50	Rp2	VZBM-A-2"-RP-25-F-3L-B2-PB120	8070273	VZBM-A-2"-RP-25-F-3L-B2-PA80	8070257
3/2-way, T-shaped hole	8	Rp1/4	VZBM-A-1/4"-RP-25-F-3T-B2-PB20	8070274	VZBM-A-1/4"-RP-25-F-3T-B2-PA10	8070258
	10	Rp3/8	VZBM-A-3/8"-RP-25-F-3T-B2-PB20	8070275	VZBM-A-3/8"-RP-25-F-3T-B2-PA10	8070259
	15	Rp1/2	VZBM-A-1/2"-RP-25-F-3T-B2-PB20	8070276	VZBM-A-1/2"-RP-25-F-3T-B2-PA10	8070260
	20	Rp3/4	VZBM-A-3/4"-RP-25-F-3T-B2-PB40	8070277	VZBM-A-3/4"-RP-25-F-3T-B2-PA20	8070261
	25	Rp1	VZBM-A-1"-RP-25-F-3T-B2-PB40	8070278	VZBM-A-1"-RP-25-F-3T-B2-PA20	8070262
	32	Rp1 1/4	VZBM-A-1 1/4"-RP-25-F-3T-B2-PB80	8070279	VZBM-A-1 1/4"-RP-25-F-3T-B2-PA40	8070263
	40	Rp1 1/2	VZBM-A-1 1/2"-RP-25-F-3T-B2-PB120	8070280	VZBM-A-1 1/2"-RP-25-F-3T-B2-PA80	8070264
	50	Rp2	VZBM-A-2"-RP-25-F-3T-B2-PB120	8070281	VZBM-A-2"-RP-25-F-3T-B2-PA80	8070265

Accessories

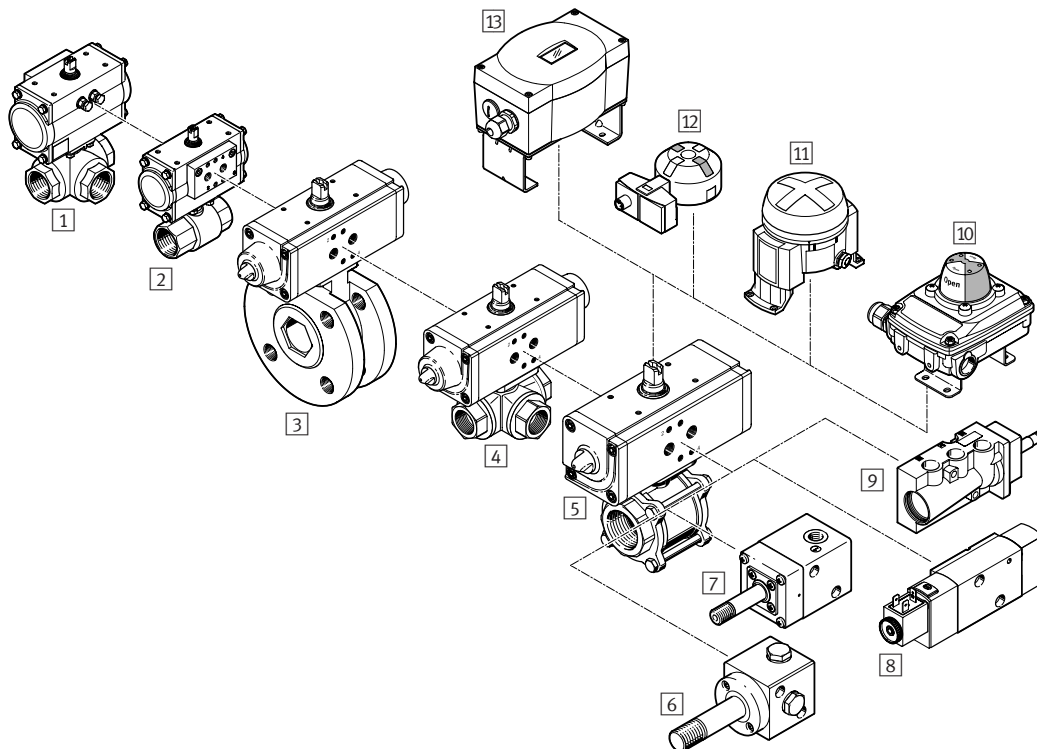

- 1 Ball valve actuator unit VZBM
Combination of double-acting or single-acting quarter turn actuator DFPD and 3-way ball valve, brass
- 2 Ball valve actuator unit VZBM
Combination of double-acting or single-acting quarter turn actuator DFPD and 2-way ball valve, brass
- 3 Ball valve actuator unit, stainless steel, compact design VZBC
→ [vzbc](#)
- 4 Ball valve actuator unit VZBA
→ 354
- 5 Ball valve actuator unit VZBA
→ 354
- 6 Solenoid valve VOFD → [vofd](#)
- 7 Solenoid valve VOFC → [vofc](#)
- 8 Solenoid valve VSNC → 157

- 9 Solenoid valve NVF3 → [nvf3](#)
- 10 Limit switch attachment SRBC
→ 330

- 11 Limit switch attachments DAPZ
→ [dapz](#)

- 12 Limit switch attachment SRBG
→ 332
- 13 Positioner CMSX → 334

Process valve units >

Ball valve actuator units VZBA

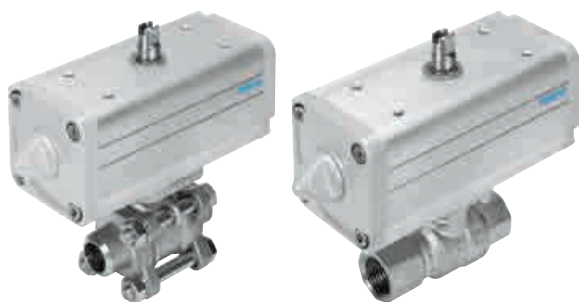

- Electric or pneumatic actuation
 - Combination of a pneumatic quarter turn actuator and a ball valve
 - Corrosion-resistant and acid-resistant versions
 - Connection pattern to NAMUR to VDI/VDE 3845
 - Flange hole pattern to ISO 5211
 - Flow is fully opened or closed in both directions
 - Limit switch attachments or limit switches can be mounted directly on the actuator unit for sensing the end positions
 - Selected types in accordance with ATEX directive for potentially explosive atmospheres
- www.festo.com/ex

Order code

001	Type
VZBA	Ball valve
002	Nominal width DN
1/4"	DN8
3/8"	DN10
1/2"	DN15
3/4"	DN20
1"	DN25
1 1/4"	DN32
1 1/2"	DN40
2"	DN50
2 1/2"	DN65
3"	DN80
4"	DN100
003	Process valve connection type 1
G	Pipe thread to DIN EN 10226-1
W	Welded end
004	Process valve connection type 2
G	Pipe thread to DIN EN 10226-1
W	Welded end
005	Process valve connection type 3
-	Without
G	Pipe thread to DIN EN 10226-1
006	Nominal pressure PN of process valve
63	63 bar
007	Design
-	Standard
T	Three-part
008	Overall length
-	Standard
009	Valve function
32L	3/2-way, L-shaped hole
32T	3/2-way, T-shaped hole
22	2/2-way
010	Flanged connection
F07	Hole pattern 07
F10	Hole pattern 10
F0304	Hole pattern 03 and 04

F0405	Hole pattern 04 and 05
F0507	Hole pattern 05 and 07
F0710	Hole pattern 07 and 10
011	Actuation type
-	Via actuator
012	Housing material
V4	Stainless steel
013	Shut-off element material
V4	Stainless steel
014	Sealing element material
T	PTFE-reinforced
015	Actuator
PP	DAPS, double-acting
PS	DAPS, single-acting
016	Torque
15	15 Nm
30	30 Nm
53	53 Nm
60	60 Nm
90	90 Nm
106	106 Nm
120	120 Nm
180	180 Nm
240	240 Nm
017	Swivel direction
-	Without
R	Right
018	Nominal swivel angle
90	90°
019	Spring ID
-	Not applicable for double-acting
1	Spring strength for connection pressure 2.8 bar
2	Spring strength for connection pressure 3.5 bar
3	Spring strength for connection pressure 4.2 bar
4	Spring strength for connection pressure 5.6 bar
020	End-position adjustment
C	Closed

Ordering – VZBA, 2-way, stainless steel

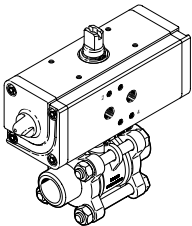
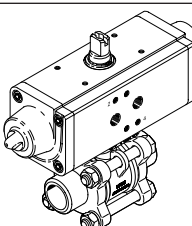
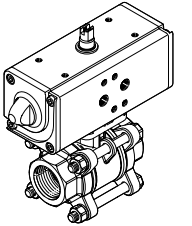
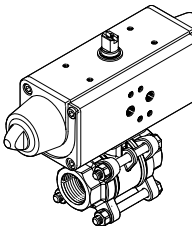
	Connection	Nominal width DN	Type	Part no.
DAPS, double-acting				
	With welded ends	8	VZBA-1/4"-WW-63-T-22-F0304-V4V4T-PP15-R-90-C	1810730
		10	VZBA-3/8"-WW-63-T-22-F0304-V4V4T-PP15-R-90-C	1810731
		15	VZBA-1/2"-WW-63-T-22-F0304-V4V4T-PP15-R-90-C	1810732
		20	VZBA-3/4"-WW-63-T-22-F0304-V4V4T-PP30-R-90-C	1810733
		25	VZBA-1"-WW-63-T-22-F0405-V4V4T-PP30-R-90-C	1810734
		32	VZBA-1 1/4"-WW-63-T-22-F0405-V4V4T-PP60-R-90-C	1810735
		40	VZBA-1 1/2"-WW-63-T-22-F0507-V4V4T-PP60-R-90-C	1810736
		50	VZBA-2"-WW-63-T-22-F0507-V4V4T-PP60-R-90-C	1810737
		65	VZBA-2 1/2"-WW-63-T-22-F0710-V4V4T-PP106-R-90-C	1810738
		80	VZBA-3"-WW-63-T-22-F0710-V4V4T-PP180-R-90-C	1810739
100	VZBA-4"-WW-63-T-22-F10-V4V4T-PP240-R-90-C	1810740		
DAPS, single-acting				
	With welded ends	8	VZBA-1/4"-WW-63-T-22-F0304-V4V4T-PS15-R-90-4-C	1774103
		10	VZBA-3/8"-WW-63-T-22-F0304-V4V4T-PS15-R-90-4-C	1774104
		15	VZBA-1/2"-WW-63-T-22-F0304-V4V4T-PS15-R-90-4-C	1774105
		20	VZBA-3/4"-WW-63-T-22-F0304-V4V4T-PS30-R-90-4-C	1774106
		25	VZBA-1"-WW-63-T-22-F0405-V4V4T-PS30-R-90-4-C	1774107
		32	VZBA-1 1/4"-WW-63-T-22-F0405-V4V4T-PS60-R-90-4-C	1774108
		40	VZBA-1 1/2"-WW-63-T-22-F0507-V4V4T-PS60-R-90-4-C	1774109
		50	VZBA-2"-WW-63-T-22-F0507-V4V4T-PS60-R-90-4-C	1774110
		65	VZBA-2 1/2"-WW-63-T-22-F0710-V4V4T-PS106-R-90-4-C	1774111
		80	VZBA-3"-WW-63-T-22-F0710-V4V4T-PS180-R-90-4-C	1774112
100	VZBA-4"-WW-63-T-22-F10-V4V4T-PS240-R-90-4-C	1774113		
Connecting thread				
DAPS, double-acting				
	Rp1/4		VZBA-1/4"-GG-63-T-22-F0304-V4V4T-PP15-R-90-C	1809651
	Rp3/8		VZBA-3/8"-GG-63-T-22-F0304-V4V4T-PP15-R-90-C	1809652
	Rp1/2		VZBA-1/2"-GG-63-T-22-F0304-V4V4T-PP15-R-90-C	1809653
	Rp3/4		VZBA-3/4"-GG-63-T-22-F0304-V4V4T-PP30-R-90-C	1809654
	Rp1		VZBA-1"-GG-63-T-22-F0405-V4V4T-PP30-R-90-C	1809655
	Rp1 1/4		VZBA-1 1/4"-GG-63-T-22-F0405-V4V4T-PP60-R-90-C	1809656
	Rp1 1/2		VZBA-1 1/2"-GG-63-T-22-F0507-V4V4T-PP60-R-90-C	1809657
	Rp2		VZBA-2"-GG-63-T-22-F0507-V4V4T-PP60-R-90-C	1809658
	Rp2 1/2		VZBA-2 1/2"-GG-63-T-22-F0710-V4V4T-PP106-R-90-C	1809659
	Rp3		VZBA-3"-GG-63-T-22-F0710-V4V4T-PP180-R-90-C	1809660
Rp4		VZBA-4"-GG-63-T-22-F10-V4V4T-PP240-R-90-C	1809661	
DAPS, single-acting				
	Rp1/4		VZBA-1/4"-GG-63-T-22-F0304-V4V4T-PS15-R-90-4-C	1758069
	Rp3/8		VZBA-3/8"-GG-63-T-22-F0304-V4V4T-PS15-R-90-4-C	1758070
	Rp1/2		VZBA-1/2"-GG-63-T-22-F0304-V4V4T-PS15-R-90-4-C	1758071
	Rp3/4		VZBA-3/4"-GG-63-T-22-F0304-V4V4T-PS30-R-90-4-C	1758072
	Rp1		VZBA-1"-GG-63-T-22-F0405-V4V4T-PS30-R-90-4-C	1758073
	Rp1 1/4		VZBA-1 1/4"-GG-63-T-22-F0405-V4V4T-PS53-R-90-4-C	1758074
	Rp1 1/2		VZBA-1 1/2"-GG-63-T-22-F0507-V4V4T-PS53-R-90-4-C	1758075
	Rp2		VZBA-2"-GG-63-T-22-F0507-V4V4T-PS90-R-90-4-C	1758076
	Rp2 1/2		VZBA-2 1/2"-GG-63-T-22-F0710-V4V4T-PS120-R-90-4-C	1758077
	Rp3		VZBA-3"-GG-63-T-22-F0710-V4V4T-PS180-R-90-4-C	1758078
Rp4		VZBA-4"-GG-63-T-22-F10-V4V4T-PS240-R-90-4-C	1758079	

Process valve units >

Ball valve actuator units VZBA

Ordering – VZBA, 3-way, stainless steel

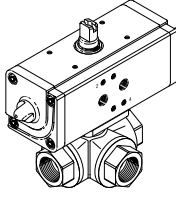
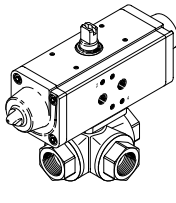
	Connection Process valve	Hole	Flow rate Kv [m³/h] Type			Type	Part no.	
			L	T right-angled	T straight			
DAPS, double-acting								
	Rp1/4	L	4.5	–	–	VZBA-1/4"-GGG-63-32L-F0304-V4V4T-PP30-R-90-C	1914785	
	Rp3/8		4.5	–	–	VZBA-3/8"-GGG-63-32L-F0304-V4V4T-PP30-R-90-C	1914786	
	Rp1/2		4.7	–	–	VZBA-1/2"-GGG-63-32L-F0304-V4V4T-PP30-R-90-C	1914787	
	Rp3/4		5.1	–	–	VZBA-3/4"-GGG-63-32L-F0405-V4V4T-PP30-R-90-C	1914788	
	Rp1		11.8	–	–	VZBA-1"-GGG-63-32L-F0405-V4V4T-PP30-R-90-C	1914789	
	Rp1 1/4		19.6	–	–	VZBA-1 1/4"-GGG-63-32L-F0405-V4V4T-PP60-R-90-C	1914790	
	Rp1 1/2		33.2	–	–	VZBA-1 1/2"-GGG-63-32L-F0405-V4V4T-PP60-R-90-C	1914791	
	Rp2		53.7	–	–	VZBA-2"-GGG-63-32L-F0507-V4V4T-PP106-R-90-C	1914792	
	Rp1/4		T	–	4.5	8	VZBA-1/4"-GGG-63-32T-F0304-V4V4T-PP30-R-90-C	1915072
	Rp3/8	–		4.5	8	VZBA-3/8"-GGG-63-32T-F0304-V4V4T-PP30-R-90-C	1915073	
	Rp1/2	–		4.8	8.3	VZBA-1/2"-GGG-63-32T-F0304-V4V4T-PP30-R-90-C	1915074	
	Rp3/4	–		4.8	8.3	VZBA-3/4"-GGG-63-32T-F0405-V4V4T-PP30-R-90-C	1915075	
	Rp1	–		10.9	22.4	VZBA-1"-GGG-63-32T-F0405-V4V4T-PP30-R-90-C	1915076	
	Rp1 1/4	–		18	36.5	VZBA-1 1/4"-GGG-63-32T-F0405-V4V4T-PP60-R-90-C	1915077	
	Rp1 1/2	–		30	62	VZBA-1 1/2"-GGG-63-32T-F0405-V4V4T-PP60-R-90-C	1915078	
	Rp2	–		48.8	100	VZBA-2"-GGG-63-32T-F0507-V4V4T-PP106-R-90-C	1915079	
	DAPS, single-acting							
		Rp1/4	L	4.5	–	–	VZBA-1/4"-GGG-63-32L-F0304-V4V4T-PS30-R-90-4-C	1915543
		Rp3/8		4.5	–	–	VZBA-3/8"-GGG-63-32L-F0304-V4V4T-PS30-R-90-4-C	1915544
Rp1/2		4.7		–	–	VZBA-1/2"-GGG-63-32L-F0304-V4V4T-PS30-R-90-4-C	1915545	
Rp3/4		5.1		–	–	VZBA-3/4"-GGG-63-32L-F0405-V4V4T-PS30-R-90-4-C	1915546	
Rp1		11.8		–	–	VZBA-1"-GGG-63-32L-F0405-V4V4T-PS30-R-90-4-C	1915547	
Rp1 1/4		19.6		–	–	VZBA-1 1/4"-GGG-63-32L-F0405-V4V4T-PS53-R-90-4-C	1915548	
Rp1 1/2		33.2		–	–	VZBA-1 1/2"-GGG-63-32L-F0405-V4V4T-PS90-R-90-4-C	1915549	
Rp2		53.7		–	–	VZBA-2"-GGG-63-32L-F0507-V4V4T-PS90-R-90-4-C	1915550	
Rp1/4		T		–	4.5	8	VZBA-1/4"-GGG-63-32T-F0304-V4V4T-PS30-R-90-4-C	1915744
Rp3/8			–	4.5	8	VZBA-3/8"-GGG-63-32T-F0304-V4V4T-PS30-R-90-4-C	1915745	
Rp1/2			–	4.8	8.3	VZBA-1/2"-GGG-63-32T-F0304-V4V4T-PS30-R-90-4-C	1915746	
Rp3/4			–	4.8	8.3	VZBA-3/4"-GGG-63-32T-F0405-V4V4T-PS30-R-90-4-C	1915747	
Rp1			–	10.9	22.4	VZBA-1"-GGG-63-32T-F0405-V4V4T-PS30-R-90-4-C	1915748	
Rp1 1/4			–	18	36.5	VZBA-1 1/4"-GGG-63-32T-F0405-V4V4T-PS53-R-90-4-C	1915749	
Rp1 1/2			–	30	62	VZBA-1 1/2"-GGG-63-32T-F0405-V4V4T-PS90-R-90-4-C	1915750	
Rp2			–	48.8	100	VZBA-2"-GGG-63-32T-F0507-V4V4T-PS90-R-90-4-C	1915751	

Accessories

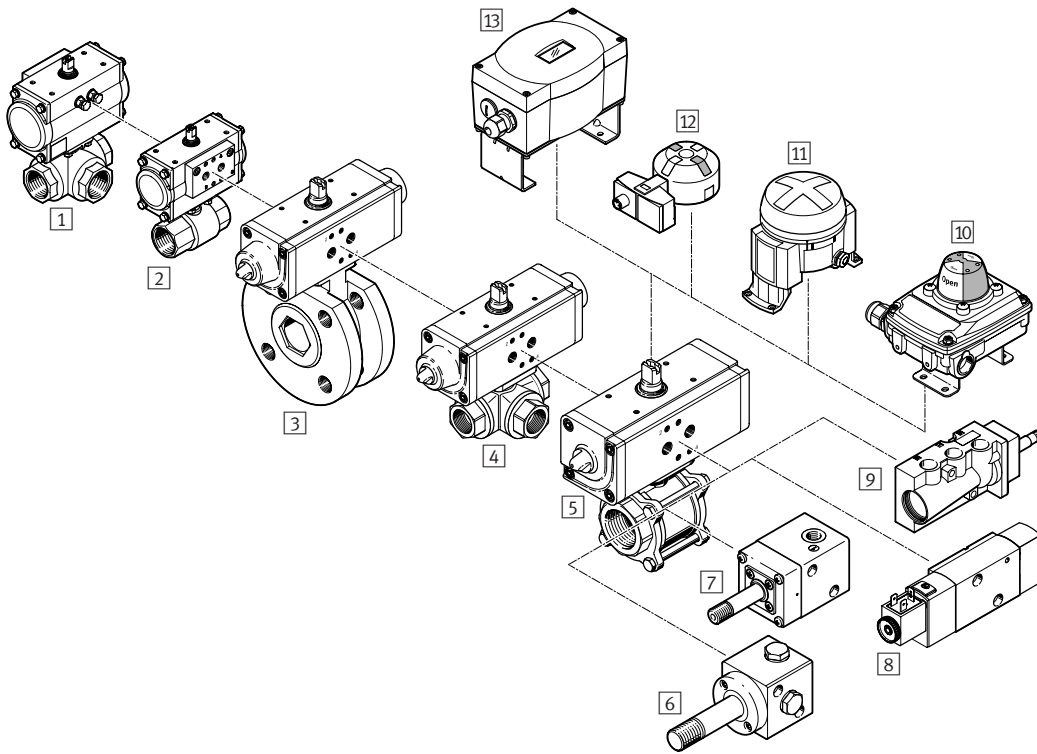

- 1 Ball valve actuator unit VZBM → 352
- 2 Ball valve actuator unit VZBM → 352
- 3 Ball valve actuator unit, stainless steel, compact design VZBC → [vzbc](#)
- 4 Ball valve actuator unit VZBA
Combination of double-acting or single-acting quarter turn actuator DAPS and 3-way stainless steel ball valve
- 5 Ball valve actuator unit VZBA
Combination of double-acting or single-acting quarter turn actuator DAPS and 2-way stainless steel ball valve
- 6 Solenoid valve VOFD → [vofd](#)
- 7 Solenoid valve VOFC → [vofc](#)
- 8 Solenoid valve VSNC → 157

- 9 Solenoid valve NVF3 → [nvf3](#)
- 10 Limit switch attachment SRBC → 330

- 11 Limit switch attachment DAPZ → [dapz](#)

- 12 Limit switch attachment SRBG → 332
- 13 Positioner CMSX → 334

Filter regulators PCRP



- Robust housing for the specific requirements of process automation
- Suitable for use outdoors and at temperatures down to -60 °C
- Resistant to UV radiation and corrosive environments
- Connection G1/4, G1/2, NPT1/4-18, NPT1/2-14
- Pressure 0.5 ... 7 bar; 0.5 ... 12 bar
- Flow rate 1920 ... 4115 l/min

Order code

001 002 003 004 005 006 007 008
 PCRP - - - - - - - -

Legend: Mandatory entry

001	Type
PCRP	Filter regulator
002	Size
44	44
64	64
003	Pneumatic connection
G14	G1/4
G12	G1/2
N14	1/4 NPT
N12	1/2 NPT
004	Pressure regulation range
7	Up to 7 bar
12	Up to 12 bar

005	Filter version
C	5 µm
E	40 µm
006	Bowl type
R1	Stainless steel
007	Condensate drain
M	Manual
008	Temperature range
T18	-20 ... +80 °C
T19	-60 ... +80 °C

Ordering

008 Temperature range -20 ... +80 °C		005 Grade of filtration 5 µm		005 Grade of filtration 40 µm	
002 Size	003 Pneumatic connection	Type	Part no.	Type	Part no.
004 Pressure regulation range 0.5 ... 7 bar					
64	G1/4	PCR-64-G14-7-C-R1-M-T18	4787803	PCR-64-G14-7-E-R1-M-T18	4787805
	G1/2	PCR-64-G12-7-C-R1-M-T18	4787811	PCR-64-G12-7-E-R1-M-T18	4787813
	1/4 NPT	PCR-64-N14-7-C-R1-M-T18	4787799	PCR-64-N14-7-E-R1-M-T18	4787801
	1/2 NPT	PCR-64-N12-7-C-R1-M-T18	4787807	PCR-64-N12-7-E-R1-M-T18	4787809
004 Pressure regulation range 0.5 ... 12 bar					
44	G1/4	PCR-44-G14-12-C-R1-M-T18	8120907	PCR-44-G14-12-E-R1-M-T18	8120906
	G1/2	PCR-44-G12-12-C-R1-M-T18	8120905	PCR-44-G12-12-E-R1-M-T18	8120904
	1/4 NPT	PCR-44-N14-12-C-R1-M-T18	8120903	PCR-44-N14-12-E-R1-M-T18	8120902
	1/2 NPT	PCR-44-N12-12-C-R1-M-T18	8120901	PCR-44-N12-12-E-R1-M-T18	8120900
64	G1/4	PCR-64-G14-12-C-R1-M-T18	4787804	PCR-64-G14-12-E-R1-M-T18	4787806
	G1/2	PCR-64-G12-12-C-R1-M-T18	4787812	PCR-64-G12-12-E-R1-M-T18	4787814
	1/4 NPT	PCR-64-N14-12-C-R1-M-T18	4787800	PCR-64-N14-12-E-R1-M-T18	4787802
	1/2 NPT	PCR-64-N12-12-C-R1-M-T18	4787808	PCR-64-N12-12-E-R1-M-T18	4787810

Ordering

008 Temperature range -60 ... +80°C						
002 Size	003 Pneumatic connection		005 Grade of filtration 5 µm		005 Grade of filtration 40 µm	
			Type	Part no.	Type	Part no.
004 Pressure regulation range 0.5 ... 7 bar						
64	G1/4		PCRP-64-G14-7-C-R1-M-T19	5394669	PCRP-64-G14-7-E-R1-M-T19	5394671
	G1/2		PCRP-64-G12-7-C-R1-M-T19	5394677	PCRP-64-G12-7-E-R1-M-T19	5394679
	1/4 NPT		PCRP-64-N14-7-C-R1-M-T19	5394665	PCRP-64-N14-7-E-R1-M-T19	5394667
	1/2 NPT		PCRP-64-N12-7-C-R1-M-T19	5394673	PCRP-64-N12-7-E-R1-M-T19	5394675
004 Pressure regulation range 0.5 ... 12 bar						
44	G1/4		-	-	PCRP-44-G14-12-E-R1-M-T19	8120898
	G1/2		-	-	PCRP-44-G12-12-E-R1-M-T19	8120899
	1/4 NPT		-	-	PCRP-44-N14-12-E-R1-M-T19	8120896
	1/2 NPT		-	-	PCRP-44-N12-12-E-R1-M-T19	8120897
64	G1/4		PCRP-64-G14-12-C-R1-M-T19	5394670	PCRP-64-G14-12-E-R1-M-T19	5394672
	G1/2		PCRP-64-G12-12-C-R1-M-T19	5394678	PCRP-64-G12-12-E-R1-M-T19	5394680
	1/4 NPT		PCRP-64-N14-12-C-R1-M-T19	5394666	PCRP-64-N14-12-E-R1-M-T19	5394668
	1/2 NPT		PCRP-64-N12-12-C-R1-M-T19	5394674	PCRP-64-N12-12-E-R1-M-T19	5394676

Accessories

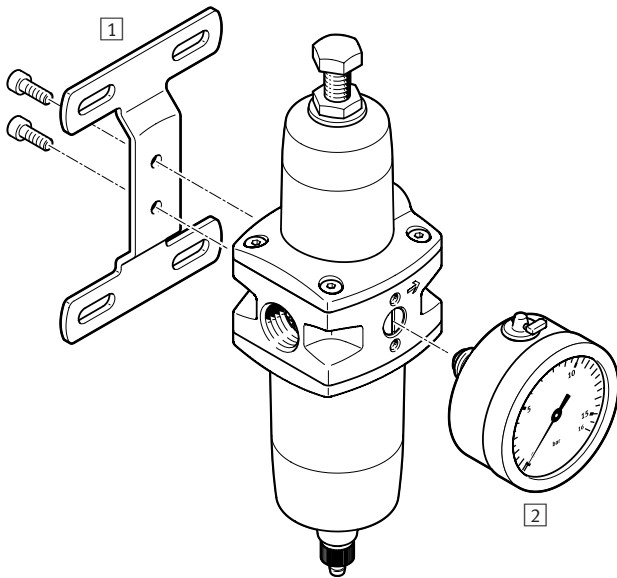

1 Mounting bracket PAMP → 359

2 Pressure gauge PAGN → 359

Filter cartridge MS4-LFP, filter made of PE → 359

Filter cartridge PFEP, filter made of high-alloy stainless steel → 359

1 Mounting bracket PAMP		
Size	Type	Part no.
44	PAMP-MB-44	8123058
64	PAMP-MB-64	8081356

2 Pressure gauge PAGN			
Size	Display range	Operating pressure	Type
			Part no.
Outer scale in bar			
63	0 ... 16 bar	0 ... 16 bar	PAGN-63-16-G14-R1-1.6-0.5-V2
			8081401

Filter cartridge MS4-LFP, PFEP			
Size	For filter regulator	Type	Part no.
Degree of filtration 5 µm			
44	PCRP-44-...-C-...-T18	MS4-LFP-C	534501
64	PCRP-64-...-C	PFEP-64-C	8081360
Degree of filtration 40 µm			
44	PCRP-44-...-E-...-T19	PFEP-44-E	8123059
	PCRP-44-...-E-...-T18	MS4-LFP-E	534502
64	PCRP-64-...-E	PFEP-64-E	8081365



Appendix

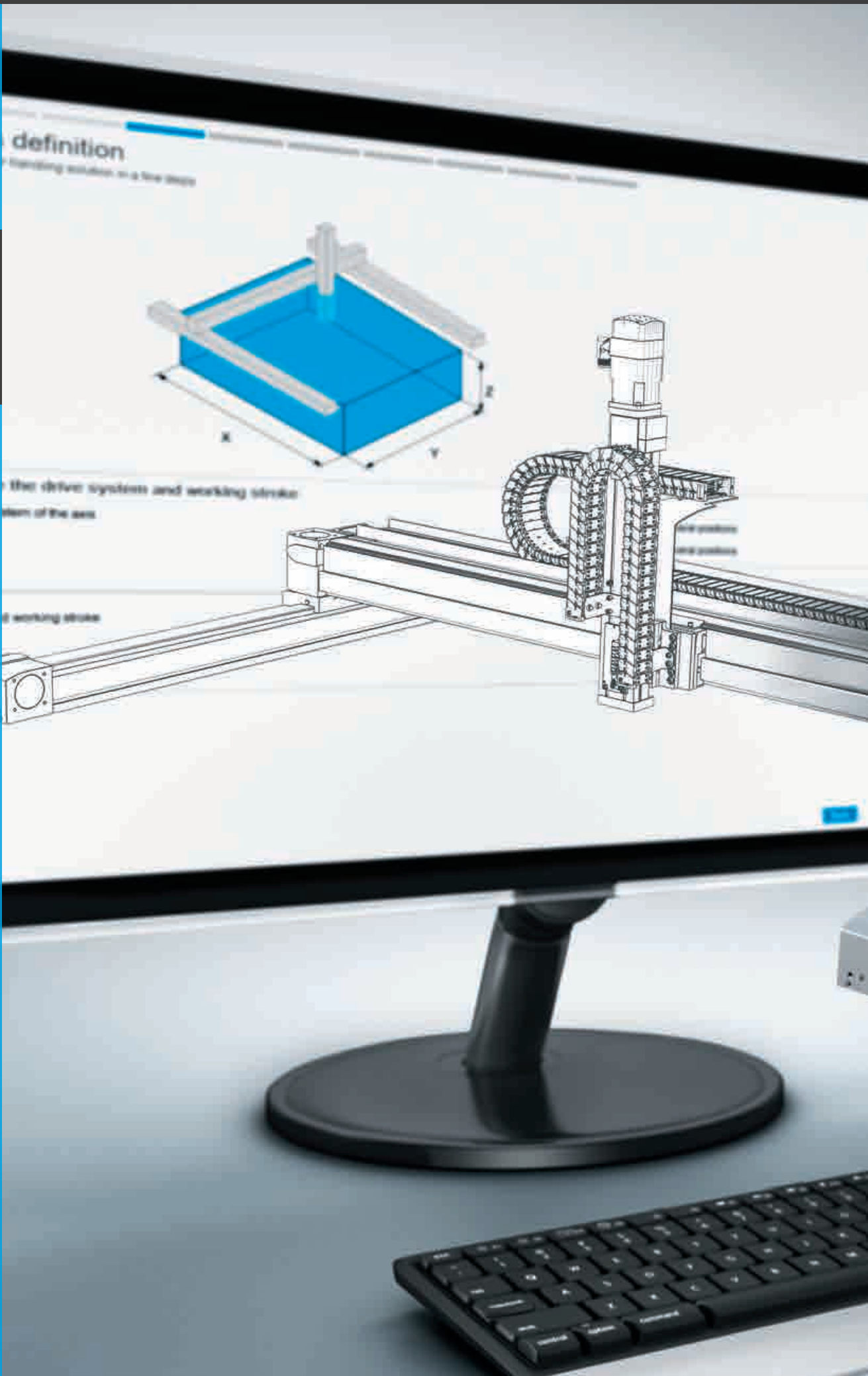

Axis definition

Define the driver system and working stroke

Drive system of the axis

Required working stroke



Contents

Energy efficiency	362
Festo Services and Support	364
Food and packaging	365
Training and consulting	366
What must be taken into account when using Festo products?	367
Trademark notices	368

Energy efficiency

Energy efficiency in focus

We make energy efficiency happen. You can rely on our technical experts and efficient technologies that will ensure your machines and systems consume fewer resources and less energy.

This not only reduces CO₂ emissions, but your operating costs too. And it leads to increases too, for example in the sustainability of your production processes and your company's productivity.

Intelligent design

- Intelligent and innovative selection software for designing systems correctly.
- Choose smaller components, avoid the accumulation of safety factors.



Products and solutions

- Festo offers products and solutions that use energy more efficiently so that you can realise significant potential savings right now,
- whether with high-performance, simple pneumatic systems or precise, highly dynamic automation technology.

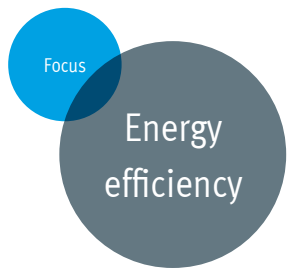

Industrial education

- Take advantage of the expertise of our sales engineers and energy efficiency consultants.
- Benefit from Festo Didactic's close links to industry and its training portfolio.



Services

- Festo Energy Saving Services: the service package for the best possible utilisation of potential savings.
- From compressed air audits to the implementation of energy-saving solutions, our specialists support you with customised services.

Simply ask your local contact person or find out more at

→ www.festo.com/energy

Festo pursues a mission of sustainable management of resources and long-term value enhancement

High energy prices, rising cost pressure and a growing awareness of climate protection have turned energy efficiency into a key business task. It applies to every part of an application and therefore requires a comprehensive approach. All parameters must be correct in order for a system or machine to be energy efficient, from the planning stage through to operation.

Pneumatic systems, too, offer attractive potential savings when it comes to energy efficiency. The key to success lies in taking a thorough look at pneumatic systems.

A sample calculation: air supply switched off during standstills

Energy efficiency module MSE6-E2M.

- Assembly system with 20% leakage
- Daily usage: approx. 10 hours production and 14 hours standby
- System consumption per day without MSE6-E2M: 1242 Nm³
- System consumption per day with MSE6-E2M: 970 Nm³

Savings: 20%

Three functions to save money

- Compressed air automatically shut off in standby mode
- Detection and notification of leakages
- Condition monitoring for process-related data, also for Industry 4.0
- With PROFINET for the three alternative connections
M12, RJ45, SCRJ

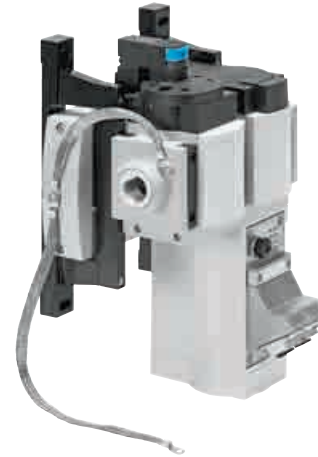

Efficient measurement and analysis with the air-flow analyser SFGA

The proven plug & work concept from Festo has also inspired the design of the air-flow analyser. The ready-to-install analysis case can be used straightaway and includes everything you need for efficiently and flexibly measuring compressed air consumption and flow rates in your system.

Highlights

- Flexible flow rate and pressure measurement with a portable analysis device with integrated battery
- Extremely easy transfer of the measured values to a PC for data processing and documentation
- Including operating software
- Secure and tidy storage in the carrying case



There are opportunities – seize them!

There are lots of opportunities for increasing energy efficiency in your production processes – they only need to be exploited! Take the time to search for possible approaches – it pays off.

Our tip: Ask for advice from the experts at Festo who are extremely knowledgeable about energy efficiency and have mastered the implementation of this integrated approach.



→ www.festo.com/energy

Festo Services and Support

Consistent and comprehensive support

Festo's service and support philosophy is based on a constant analysis of the value chains of different types of customers.

Festo has built on this knowledge to develop a sophisticated portfolio that supports you along your entire value chain.

It includes numerous services such as the Energy Saving Services, customised developments of ready-to-install solutions and special designs.

Our digital information system now consists of a database-driven catalogue with over 30,000 products and accessories as well as tools for configuration, planning and design. Globally standardised application platforms for product lifecycle, production, logistics, sales and finance help to create integrated, global processes for your benefit.

Engineering



- Consulting
- Design aids
- 2D/3D CAD drawings and models
- Design and sizing tools
- Selection tools
- Engineering of ready-to-install solutions

Procurement/logistics



- Festo Online Shop
- 24-hour delivery service
- Logistics optimisation service
- PrePack

Assembly and commissioning



- Commissioning axis systems
- Compressed air consumption analysis
- Commissioning and training for servo-pneumatic welding guns

Operation



- Worldwide after sales service
- Energy Saving Services
- Compressed air quality analysis
- Support portal with documentation for the entire product lifecycle

Are you interested in these services?

Simply ask your local contact person or find out more at → www.festo.com/services

You will find further information about our services there.



Food safety and efficiency ...

... are key requirements.

Our clever mix of solutions provides the perfect ingredients for production facilities that produce high-quality food economically.

→ www.festo.com/food

→ www.festo.com/packaging

Reliable and efficient compressed air



Decide what kind of compressed air quality you need for your application. Our preconfigured service units are designed to meet your requirements and can be ordered with just a single part number. Save energy by automatically shutting off the compressed air in stand-by mode. The energy efficiency module E2M monitors and regulates the compressed air supply fully automatically.

Certified food safe



Manage demanding applications for clean and safe dispensing of food with the pneumatic pinch valve VZQA. Its silicone diaphragm comes in an N/O variant and with a declaration of conformity in accordance with Regulation (EC) No. 1935/2004. This pinch valve variant has thus been approved for direct contact with food products.

Maximum performance



Fast, simple and energy-efficient.

Decentralised valve terminal concepts increase the productivity of your systems. With the clean design valve terminal MPA-C there's no need for a control cabinet thanks to degree of protection IP69K.

Or you can use valve terminal VTUG in the control cabinet, with multi-pin plug, all common fieldbuses or IO-Link®.

High operational reliability



Reliable components are essential for high machine availability.

Take the stainless-steel cylinder CRDSNU from our clean design drive portfolio, for example. It's always correctly set thanks to the self-adjusting end position cushioning system PPS – and has no adjusting screw where dirt can accumulate.

Training and consulting

Festo is a global leading supplier of automation technology and, together with Festo Didactic, the international market leader for technical training solutions. As an integral part of the Festo Group, Festo Training and Consulting is rooted in the world of automation, and industry is just part of its DNA.

Overview of topics



We work closely with Festo Automation and operate in the same segments as our customers. This provides us with in-depth insights into our customers' challenges and enables us to offer tailored and practical training courses for industry. Our main focus is on the core business of automation technology.

- Pneumatics
- Hydraulics
- PLCs (programmable logic controllers)
- Electrical engineering/electronics
- Process automation
- Handling systems
- Water management
- Maintenance
- Supply chain management
- Lean production
- Process optimisation
- Service and sales competence
- Industry 4.0

Training offered



- Public courses
- Company-specific training courses
- Consulting
- Coaching
- Skills programmes
- Business games
- Learning needs analysis, certification, blended learning concepts

Our competency – based on actual practice for real-life applications



- Industry-focused
- Global
- Customer-oriented
- Over 50 years of experience
- Certified to DIN ISO 29990:2010 as a learning service provider
- Practical learning with state-of-the-art equipment and systems
- Trainers with many years of practical experience
- In-depth knowledge of training methods and principles
- 2,900 courses annually
- 39 languages
- 42,000 participants worldwide

Do you want more details about Festo Didactic's programme or courses in your area? Simply ask your local contact person or find out more at www.festo-tac.com

What must be taken into account when using Festo products?

The limit values specified in the technical data and any specific safety instructions must be adhered to by the user in order to ensure correct functioning.

The pneumatic components must be supplied with correctly prepared compressed air without aggressive media.

Take the ambient conditions at the place of use into consideration. Corrosive, abrasive and dusty environments (e.g. water, ozone, grinding dust) will reduce the service life of the product.

Check the resistance of the materials of Festo products to the media used and surrounding media.

When Festo products are used in safety-oriented applications, all national and international laws and regulations, for example the EC Machinery Directive, must be observed and complied with together with the relevant references to standards, trade association rules and the applicable international regulations.

Unauthorised conversions or modifications to products and systems from Festo constitute a safety risk and are thus not permitted.

Festo doesn't accept any liability for any resulting damage.

You should contact Festo if one of the following applies to your application:

- The ambient conditions and conditions of use or the operating medium differ from the specified technical data.
- The product is to perform a safety function.
- A risk or safety analysis is required.
- You are unsure about the product's suitability for the planned application.
- You are unsure about the product's suitability for use in safety-oriented applications.

All technical data is correct at the time of going to print.

All content, texts, representations, illustrations and drawings included in this catalogue are the intellectual property of Festo SE & Co. KG and are protected by copyright law.

Any duplication, processing, translation, microfilming, storage, or processing in electronic systems of any kind whatsoever without the consent of Festo SE & Co. KG is prohibited.

All technical data is subject to change according to technical updates.

ABB® is a registered trademark of ABB Asea Brown Boveri Ltd. in certain countries.

Allen-Bradley® is a registered trademark of Rockwell Automation, Inc. in certain countries.

ANSI® is a registered trademark of the American National Standards Institute, Incorporated in certain countries.

AS-Interface® is a registered trademark of Verein zur Förderung busfähiger Interfaces für binäre Aktuatoren und Sensoren e. V. in certain countries.

ASME® is a registered trademark of the American Society of Mechanical Engineers in certain countries.

Beckhoff® is a registered trademark of Hans Beckhoff in certain countries.

Cage Clamp® is a registered trademark of WAGO Kontakttechnik GmbH & Co. KG in certain countries.

CANopen® is a registered trademark of CAN in AUTOMATION - International Users and Manufacturers Group e.V. in certain countries.

CC-LINK® is a registered trademark of Mitsubishi Electric Corporation in certain countries.

CiROS® is a registered trademark of Dortmunder Initiative zur rechnerintegrierten Fertigung (RiF) e.V. in certain countries.

CODESYS® is a registered trademark of 3S-Smart Software Solutions GmbH in some countries.

DeviceNet® is a registered trademark of ODVA, Inc. in certain countries.

EasyIP® is a registered trademark of Novagraaf Nederland B.V. in certain countries.

ECOLAB® is a registered trademark of Ecolab USA, Inc. in certain countries.

EHEDG European Hygienic Engineering & Design Group® is a registered trademark of Stichting Ehedg in certain countries.

EnDat® is a registered trademark of Dr. Johannes Heidenhain GmbH in certain countries.

ePLAN electric P8® and ePLAN fluid® are registered trademarks of EPLAN Software & Service GmbH & Co. KG in certain countries.

EtherCAT® is a registered trademark of Beckhoff Automation GmbH in certain countries.

Ethernet POWERLINK® is a registered trademark of ABB ASEA BROWN BOVERI LTD COMPANY in certain countries.

EtherNet/IP® is a registered trademark of ODVA, Inc. in certain countries.

Excel® is a registered trademark of Microsoft Corporation in certain countries.

Fin Ray® is a registered trademark of EvoLogics GmbH in certain countries.

HACCP - Hazard Analysis Critical Control Points® is a registered trademark of Rizzo Graziana in certain countries.

HARAX® is a registered trademark of HARTING Electric GmbH & Co. KG in certain countries.

HIPERFACE® is a registered trademark of Sick Stegmann GmbH in certain countries.

International Electrotechnical Commission® is a registered trademark of the International Electrotechnical Commission in certain countries.

INTERBUS® is a registered trademark of Phoenix Contact GmbH & Co. KG in certain countries.

IO-Link® is a registered trademark of Profibus Nutzerorganisation e.V. in certain countries.

JohnsonDiversey® is a registered trademark of S.C. Johnson & Son, Inc. in certain countries.

Loctite® is a registered trademark of Henkel IP & Holding GmbH in certain countries.

Makrolon® is a registered trademark of Covestro Deutschland AG in certain countries.

Microsoft® is a registered trademark of Microsoft Corporation in certain countries.

MITSUBISHI® is a registered trademark of Mitsubishi Corporation in certain countries.

Modbus® is a registered trademark of Schneider Electric USA, Inc. in certain countries.

NAMUR® is a registered trademark of NAMUR - Interessengemeinschaft Automatisierungstechnik der Prozessindustrie e.V. in certain countries.

ODVA® is a registered trademark of ODVA, Inc. in certain countries.

OPC UA® is a registered trademark of the OPC Foundation in certain countries.

PROFIsafe® is a registered trademark of Siemens Aktiengesellschaft in certain countries.

Rockwell Automation® is a registered trademark of Rockwell Automation, Inc. in certain countries.

SERCOS interface® is a registered trademark of SERCOS International e.V. in certain countries.

SIMATIC® is a registered trademark of Siemens Aktiengesellschaft in certain countries.

SucoNet® is a registered trademark of Eaton Electrical IP GmbH & Co. KG in certain countries.

Systainer® is a registered trademark of TTS Tooltechnic Systems AG & Co. KG in certain countries.

Teflon® is a registered trademark of The Chemours Company FC in certain countries.

TORX® is a registered trademark of Acument Intellectual Properties, LLC in certain countries.

TwinCAT® is a registered trademark of Beckhoff Automation GmbH in certain countries.

UL® is a registered trademark of Underwriters Laboratories Inc. in certain countries.

VDMA® is a registered trademark of Verband Deutscher Maschinen- und Anlagenbau (VDMA) e.V. in certain countries.

Viton® is a registered trademark of The Chemours Company FC in certain countries.

Vulkollan® is a registered trademark of Covestro Deutschland AG in certain countries.

Windows® is a registered trademark of Microsoft Corporation in certain countries.

The above-mentioned trademarks are registered/applied-for trademarks of the respective trademark holder in certain countries.

All other trademarks not listed here are the property of their respective owners in some countries.

Specially selected:

Products for factory and
process automation

135358 (EN)
Subject to change
2021/02

www.festo.com